

# CX SPORT

In-Ear Wireless

Instruction Manual



# Contents



- Important safety instructions ..... 2**
- The CX SPORT In-Ear Wireless headphones..... 4**
- Package includes..... 6**
- Product overview.....7**
  - Overview of the headphones ..... 7
  - Overview of pictograms.....8
  - Overview of the LED indications ..... 10
  - Overview of buttons ..... 11
- Getting started ..... 12**
  - Charging basics..... 12
  - Pairing the headphones ..... 14
- Using the in-ear headphones ..... 17**
  - Wearing the headphones.....17
  - Switching the headphones on ..... 18
  - Switching the headphones off ..... 18
  - Adjusting the volume ..... 19
  - Checking the battery life of the headphones.....20
- Playing music/videos.....21**
  - Controlling music playback.....22
- Making calls on the headphones ..... 23**
  - Voice control function.....25
- Care and maintenance ..... 26**
  - Changing ear adapters and ear fins.....26
  - Cleaning the in-ear headphones .....26
  - Storage and handling .....27
  - Information about the rechargeable battery.....28
- Troubleshooting..... 29**
  - Clearing previously paired devices ..... 30
- Specifications .....31**
- Trademarks ..... 32**



## Important safety instructions

- ▶ Read this instruction manual carefully and completely before using the product.
- ▶ Do not use an obviously defective product.
- ▶ Only use the product in environments where **Bluetooth®** wireless transmission is permitted.

### Preventing damage to health and accidents

- ▶ Protect your hearing from high volume levels. Permanent hearing damage may occur when headphones are used at high volume levels for long periods of time. Sennheiser headphones sound exceptionally good at low and medium volume levels. 
- ▶ Do not insert the ear canal phones too deep into your ears and never insert them without ear adapters. Always extract the ear canal phones from your ears very slowly and carefully.
- ▶ The product generates stronger permanent magnetic fields that could cause interference to cardiac pacemakers, implanted defibrillators (ICDs) and other implants. Always maintain a distance of at least 3.94" (10 cm) between the product component containing the magnet and the cardiac pacemaker, implanted defibrillator or other implant. 
- ▶ Keep the product, accessories and packaging parts out of reach of children and pets to prevent accidents and choking hazards.
- ▶ Do not use the product in situations which require special attention (e.g. in traffic or when performing skilled jobs).

### Preventing damage to the product and malfunctions

- ▶ Always keep the product dry and do not expose it to extreme temperatures to avoid corrosion or deformation.
- ▶ Only use attachments/accessories/spare parts supplied or recommended by Sennheiser.
- ▶ Use the product with care and store it in a clean, dust-free environment.



**Intended use/Liability**

These in-ear wireless headphones are designed for use with mobile devices (e.g. mobile music players, mobile phones, tablets) that support wireless communication via Bluetooth. Compatible Bluetooth devices include those that support the following profiles: Hands Free Profile (HFP), Advanced Audio Distribution Profile (A2DP), and Audio/Video Remote Control Profile (AVRCP).

It is considered improper use when this product is used for any application not named in the associated instruction manuals and product guides.

Sennheiser does not accept liability for damage arising from abuse or misuse of this product and its attachments/accessories.

Before putting the product into operation please observe the respective country-specific regulations!

**Safety instructions for the Lithium-Polymer battery pack**

**WARNING**

In extreme cases, abuse or misuse of the Lithium-Polymer battery pack can lead to:



- explosion
- fire development
- heat generation
- smoke or gas development



Dispose of products with built-in rechargeable batteries at special collection points or return them to your specialist dealer.



Only use rechargeable batteries and chargers recommended by Sennheiser.



Charge products with built-in rechargeable batteries at ambient temperatures between 10 and 40°C/50 and 104°F.



Switch battery-powered products off after use.



When not using the product for extended periods of time, charge its built-in rechargeable batteries regularly (about every 3 months).



Do not heat above 70°C/158°F, e.g. do not expose to sunlight or throw into fire.



Do not charge a product with built-in rechargeable batteries if the product is obviously defective.

## The CX SPORT In-Ear Wireless headphones

The CX SPORT In-Ear Wireless headphones deliver detailed sound and enhanced bass with Bluetooth 4.2 and Qualcomm® aptX™ for true Hi-Fi sound.

The CX SPORT features reliable ear fins and a cable organizer to provide extra support and convenience for people with very active lifestyle.

### Features

- Sweat and splash water resistance
- High quality sports in-ear wireless headphones tuned for clarity and superior bass
- Ergonomic and robust sport in-ear wireless headphones for active lifestyle
- Supports Qualcomm® aptX™ for true Hi-Fi sound
- 6 hour battery life with 1.5 hour charging

### Bluetooth



The CX SPORT In-Ear Wireless headphones comply with the **Bluetooth** 4.2 standard and are compatible with all **Bluetooth** 1.1, 1.2, 2.0, 2.1, 3.0, 4.0 and 4.1 devices with the following profiles: Hands Free Profile (HFP), Advanced Audio Distribution Profile (A2DP), and Audio/Video Remote Control Profile (AVRCP).

### aptX™

**Qualcomm®  
aptX™**



With aptX™ audio coding, you can be assured of crisp, pure and full stereo sound. It allows you to not only hear, but experience and feel the audio as it was intended. Utilizing aptX™, **Bluetooth** technology can now offer wireless audio quality that is indistinguishable from the highest quality wired connection.

### aptX™ LL

**Qualcomm® aptX™  
Low Latency**



Qualcomm® aptX™ LL (Low Latency) audio ensures your **Bluetooth®** wireless enabled device can deliver sound in sync with visual media. It reduces delay and improves end-to-end speed of the audio transmission, resulting in a high quality, synchronized user experience. With aptX Low Latency you can enjoy the freedom of wireless for applications such as gaming and watching videos.

## Package includes

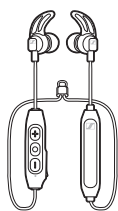

Headphones



Storage pouch



Ear fins

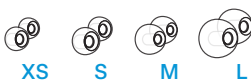

Ear adapters

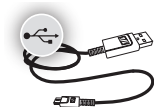

USB cable for charging



Cable Clip

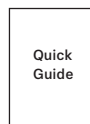

Quick guide

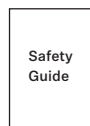

Safety guide

**i** A list of accessories can be found at [www.sennheiser.com](http://www.sennheiser.com). For information on suppliers, contact your local Sennheiser partner: [www.sennheiser.com](http://www.sennheiser.com) > “Sales Partner“.



# Product overview

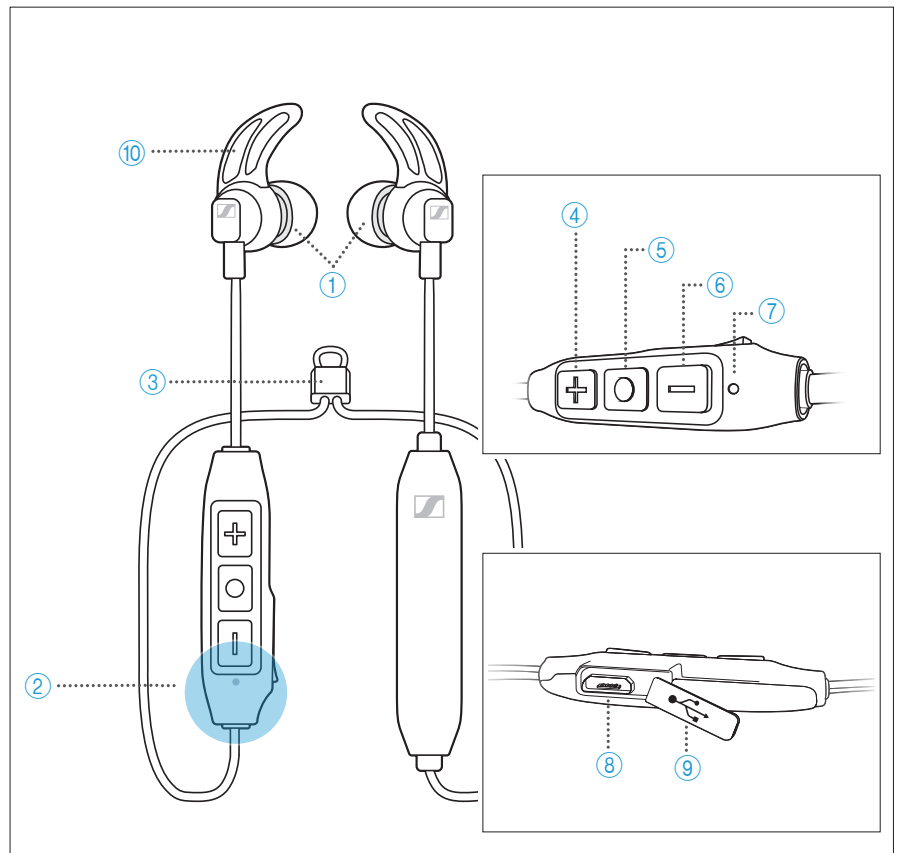

## Overview of the headphones





- |                                   |                         |
|-----------------------------------|-------------------------|
| ① Ear adapters                    | ⑥ Volume/track - button |
| ② Bluetooth antenna (not visible) | ⑦ LED                   |
| ③ Cable organizer                 | ⑧ Micro-USB input       |
| ④ Volume/track + button           | ⑨ Micro-USB cover       |
| ⑤ Multifunction button            | ⑩ Ear fins              |

## Overview of pictograms





### Pictograms for pressing a button

Pictogram	Meaning
	Press and immediately release the button
	Press the button twice
	Press the button and hold for 2 seconds

### Pictograms for the LED

Pictogram	Meaning
	The LED lights up
	The intervals signify flashing
...	The LED lights up/flashes continuously
	The time the LED lights up before blinking

Examples of pictograms that may be used in this manual:

Pictogram	Meaning
	The LED flashes continuously
	The LED lights up for 3 seconds, then off, and repeat
	The LED lights up, then off for 2 seconds, and repeat
	The LED lights up continuously
	The LED continuously flashes blue and red per second

### The pictogram “i”

 Notes marked with the pictogram “i” provide useful information on the use of the headphones.

## Overview of the LED indications

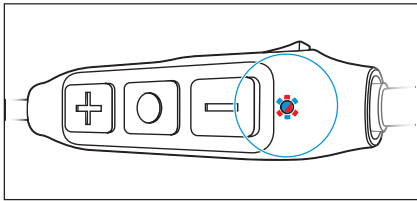

### LED indications during operation

LED	Meaning
	The headphones switch on Pairing/connecting with a device is successful
	The headphones switch off Pairing with a device is unsuccessful
	The headphones are in pairing mode
	Incoming call
	The device is/devices are successfully cleared from the headphones
	The headphones are in idle mode (e.g. headphones are paired but not connected to the device)

## Overview of buttons

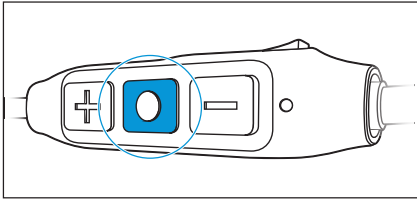

### Multifunction button

Press	Function	Page
↓ 1x	Accepts/ends a call	23
↓ 1s	Accepts an incoming call and ends the active call	23
↓ 1s	Plays/pauses a track	22
↓ 1s	Rejects a call	23
↓ 1s	Transfers a call between the headphones and the smartphone	24
↓ 2x	Accepts an incoming call and holds the active call/Toggles between 2 calls	23
↓ 3x	Activates the voice control	25

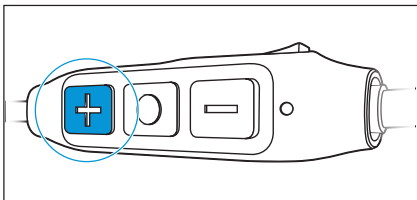

### Volume/track + button

Press	Function	Page
↓ 1x	Increases the volume	19
↓ 1s	Plays the next track	22

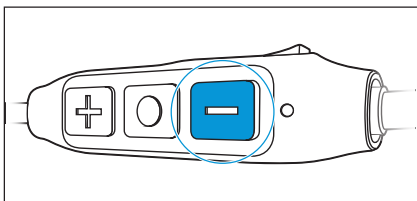

### Volume/track - button

Press	Function	Page
↓ 1x	Decreases the volume	19
↓ 1s	Plays the previous track	22



# Getting started

## Charging basics



A complete charging cycle takes about 1.5 hours. Before using the headphones for the first time, charge their rechargeable battery for a complete charging cycle without interruption.

It is recommended to charge the headphones using only the supplied USB cable. If you are charging using an external USB-power adapter, it is recommended to use an adapter with an output rating of 500 mA or higher.

LED	Meaning
	Charging
	Fully charged

### Charging the headphones

1. Open the micro-USB cover to access the micro-USB input.
2. Connect the micro-USB plug of the charging cable to the micro-USB input of the headphones.
3. Connect the USB plug to the USB charging port.

The LED flashes/lights up depending on the battery life of the headphones. The headphones utilize an intelligent battery charging technology that prevents overcharging.

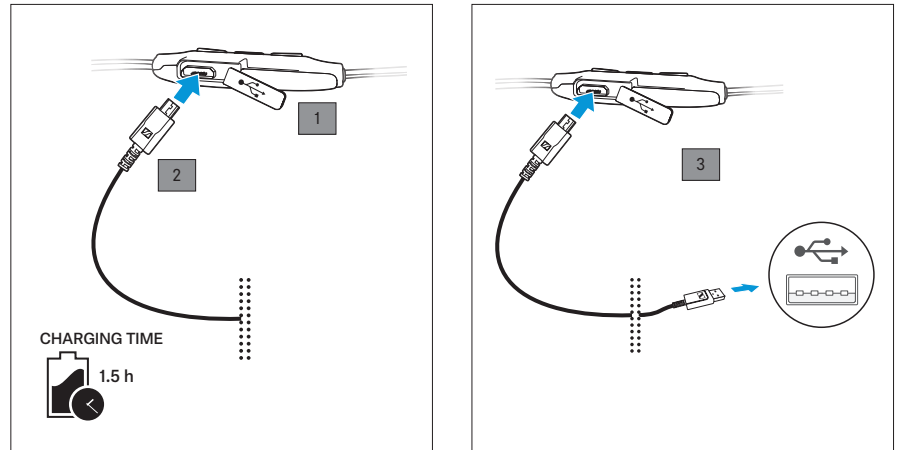

**i** Charging time may take longer at ambient temperatures below 15°C/ 59°F.

## Pairing the headphones

### CAUTION

Danger of malfunction!



The transmitted radio waves of mobile phones can impair the operation of sensitive and unprotected devices.

- ▶ Only make calls with the headphones in locations where **Bluetooth** wireless transmission is permitted.

The CX SPORT In-Ear Wireless headphones comply with the **Bluetooth 4.2** standard.

When you switch the headphones on for the first time, they automatically go to pairing mode. If the headphones have already been paired with a few devices, they automatically try to connect to the two most-recently connected **Bluetooth** devices. The headphones can save the connection profiles of up to eight **Bluetooth** devices or smartphones.

If you pair the headphones with a ninth **Bluetooth** device, the saved connection profile of the least used **Bluetooth** device will be overwritten. If you want to re-establish a connection with the overwritten **Bluetooth** device, you have to pair the headphones again.

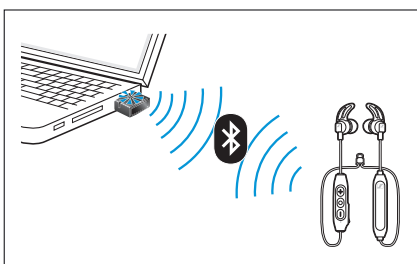
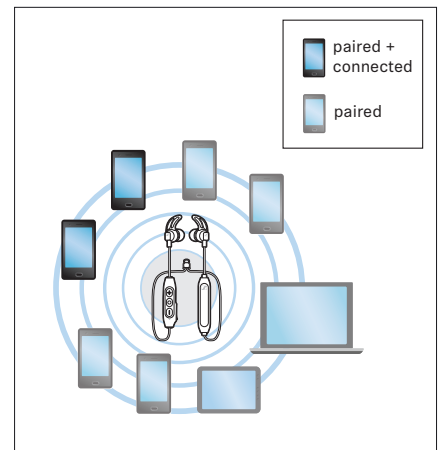
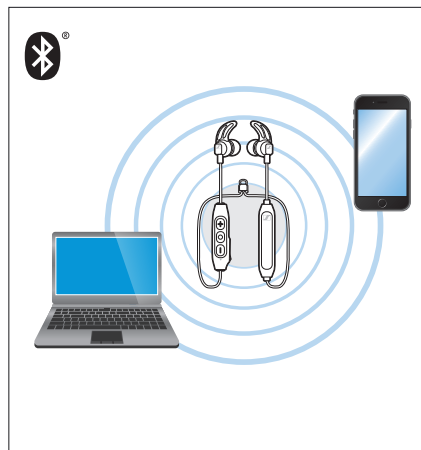

**i** To pair and connect the headphones to a PC or Mac, it is recommended to use a Sennheiser **Bluetooth** USB dongle, such as the **BTD 800 USB**.





### Pairing the headphones with a Bluetooth device

Ensure that the headphones are off and within the 20 cm range of your smartphone when performing this procedure.

**i** The headphones automatically go to pairing mode when switched on for the first time.

1. Press the multifunction button for 4 seconds.  
You hear the voice prompt “power on”, followed by a beep sound. The LED flashes blue and red. The headphones are in pairing mode.
2. Activate **Bluetooth** on your smartphone.
3. On your smartphone, start a search for **Bluetooth** devices.  
All active **Bluetooth** devices in the proximity of your smartphone are displayed.
4. From the list of **Bluetooth** devices found, select “CX SPORT”. If necessary, enter the default PIN code “0000”.  
If pairing was successful, you hear the voice prompt “connected”. The LED flashes blue 3 times.

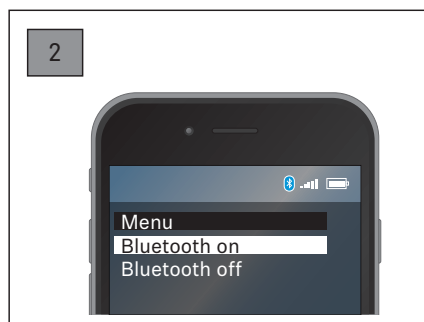
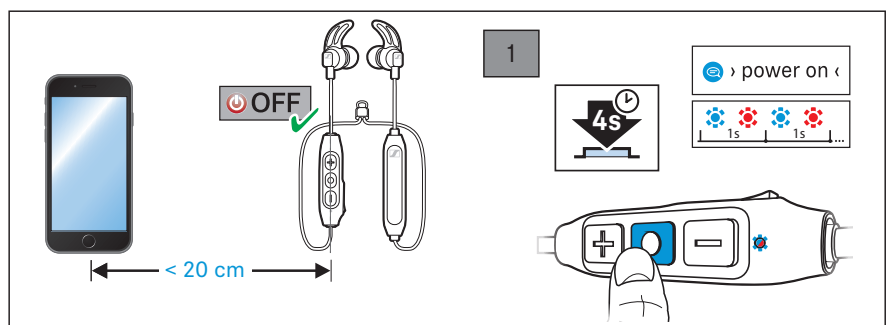

**i** If no connection is established within 5 minutes, pairing mode is terminated and the headphones switch off. If necessary, repeat the pairing procedure.

### Disconnecting the headphones from your Bluetooth device

- ▶ Deactivate Bluetooth on your smartphone.

The headphones are disconnected from the smartphone. The headphones then search for other paired devices. If no device is found, you hear the voice prompt “lost connection”. The headphones go to idle mode.

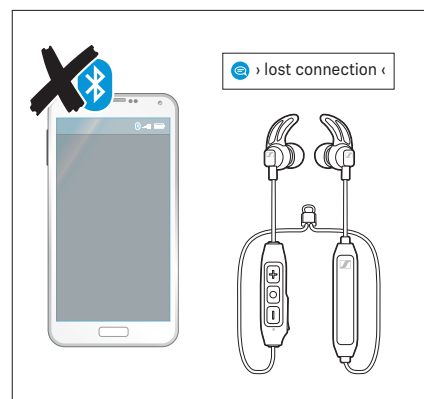
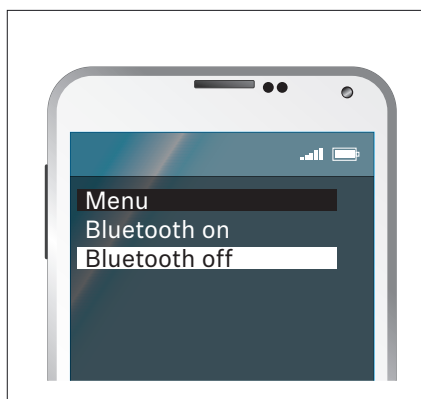

## Using the in-ear headphones

### Wearing the headphones

1. You can wear the in-ear headphones with the cables either behind your head or in front.
2. Ensure that the ear adapters fit your ears perfectly and that the ear fins are secured at the top of the ear bowl.
3. Adjust the cable organizer to get a perfect fit.
4. When running or working out, use the clip to ensure that the in-ear headphones stay attached to your neck or shirt.

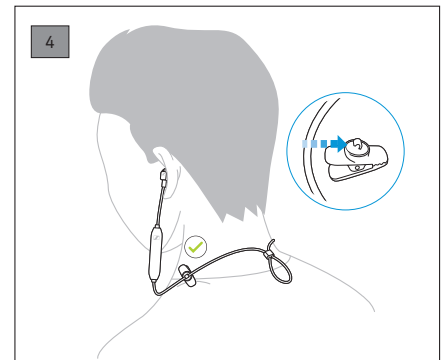
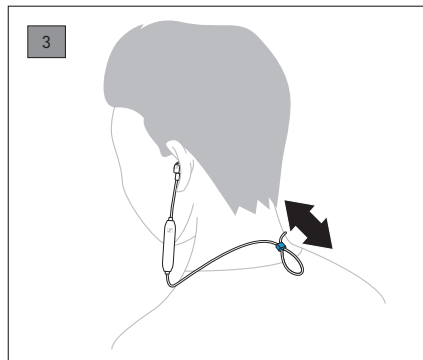
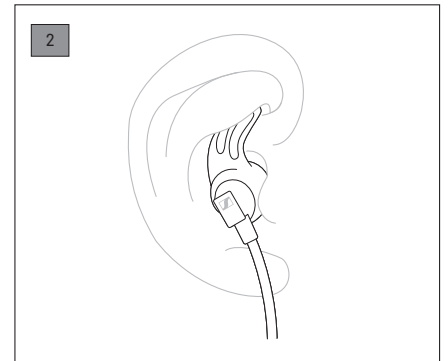
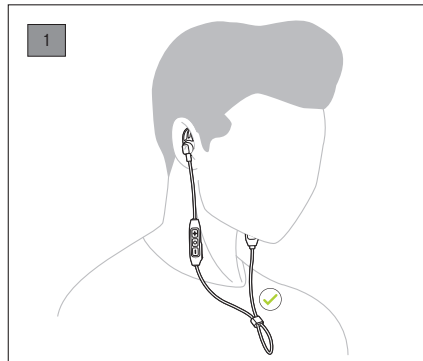

**i** By default, medium-sized ear adapters and ear fins are provided with the headphones. If necessary, replace the ear adapters and ear fins with the size that perfectly fits your ears.

## Switching the headphones on

---

### WARNING

Danger due to high volume levels!



Listening at high volume levels for long periods of time can lead to permanent hearing defects.

- ▶ Before putting the headphones on, set the volume to a low level.
  - ▶ Do not continuously expose yourself to high volume levels.
- 

- ▶ Press the multifunction button for 2 seconds.  
You hear the voice prompts “power on” and “connected”. The LED flashes blue 3 times.

 Ensure that **Bluetooth** is active on your smartphone when switching the headphones on.

## Switching the headphones off

- ▶ Press the multifunction button for 4 seconds.  
You hear the voice prompt “power off”. The LED flashes red 3 times.

## Adjusting the volume

### WARNING

Danger due to high volume levels!







Listening at high volume levels for long periods of time can lead to permanent hearing defects. Switching between audio sources may cause enormous volume jumps that can permanently damage your hearing.

- ▶ Before putting the headphones on and before switching between audio sources, adjust the volume to a low level.
- ▶ Do not continuously expose yourself to high volume levels.

You can adjust the volume for music and phone calls, depending on your preferred sound level.

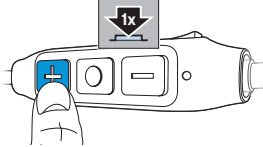
- ▶ Press the volume/track + or - button once to increase or decrease the volume.

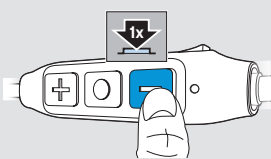



When the minimum or maximum volume is reached, you hear an alert.

Press	Function
	 Increases the volume
	 Decreases the volume

## Checking the battery life of the headphones

You can check the remaining play and talk time when the headphones are in idle mode, are not actively playing music, or are not used for making calls.

- ▶ Quickly press the Volume/track - button.  
You hear the voice prompt announcing the remaining play time.

Voice prompt	LED	Meaning
“recharge headset”		Battery is almost empty (less than 2% charged)
“below 1 hour play time”		Battery is less than 10% charged
“between 1 and 2 hours play time”		Battery is less than 20% charged
“between 2 and 4 hours play time”		Battery is less than 50% charged
“between 4 and 6 hours play time”		Battery is more than 50% charged

### Battery life indicator on your device

The battery life of your headphones may also be displayed on the screen of your smartphone or device.

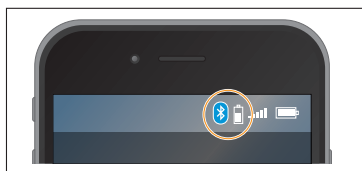

## Playing music/videos



If your audio source supports the aptX or aptX LL codec, the CX SPORT In-Ear Wireless automatically plays your music wirelessly in stunning high-resolution audio quality. If the audio source does not support any of these audio codecs, the CX SPORT In-Ear Wireless plays music in standard audio quality.

If you are using the headphones to watch videos on a device that supports the aptX LL codec, the synchronization of sound to the visual media is automatically optimized, thus giving you a highly accurate audio-visual experience.

- ▶ Pair and connect the headphones with your smartphone, see page 14.
- ▶ Play music/videos on your smartphone or device.  
The audio plays through the CX SPORT In-Ear Wireless headphones.

## Controlling music playback

The following music functions are available when the headphones and device are connected using **Bluetooth**. Some smartphones or music players may not support all functions.

### Playing/pausing music

- ▶ Quickly press the multifunction button.

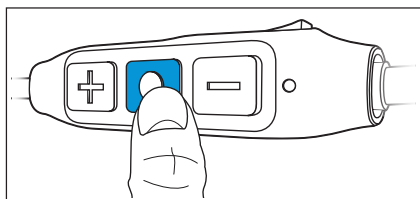

Press	Function
	Plays or pauses music

### Playing the next track

- ▶ Press and hold the volume/track + button for a second to play the next track.

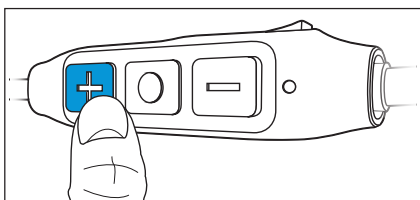

Press	Function
	Plays the next track in the playlist

### Playing the previous track

- ▶ Press and hold the volume/track - button for a second to play the previous track.

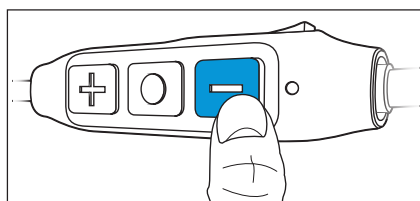

Press	Function
	Plays the previous track in the playlist



# Making calls on the headphones

The following call functions are available when the headphones and the smartphone are connected using **Bluetooth**. Some smartphones may not support all functions.

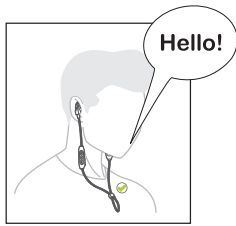
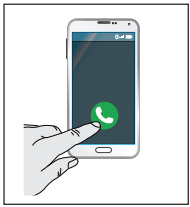

## Making a call

► Dial the desired number on your smartphone.

**i** If your smartphone does not automatically transfer the call to the headphones, select CX SPORT In-Ear Wireless as the audio source on your smartphone (see the instruction manual of your smartphone if necessary).

## Accepting/rejecting/ending a call

If your headphones are connected to a smartphone and you receive a call, the ring tone plays in the headphones and the LED flashes purple.

If you are playing music when you receive a call, the music pauses until you end the call.



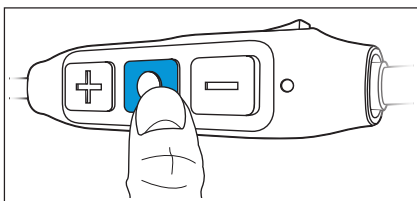

► Press the multifunction button accordingly:



Press	Function	Voice prompt
1x		Accepts a call
1x		Ends a call "call ended"
1s		Rejects a call "call rejected"
1x	 	Accepts an incoming call and ends the active call
2x		Puts the call on hold
2x	 	Accepts an incoming call and puts an active call on hold
2x	 	Toggles between 2 active calls
1s	  	Rejects an incoming call and continues the active call

### Muting/unmuting a call





► Quickly press the multifunction button twice while on a call.

Press	Function
	 Mutes the call
	 Unmutes the call

### Transferring a call to/from the headphones

When a call has been established, you can transfer the call between the headphones and the smartphone.





► Press and hold the multifunction for a second.

Press	Function
	 Transfers a call from the headphones to the smartphone
	 Transfers a call from the smartphone to the headphones

### Redialing

You can use this function when the headphones are not actively playing music or are used for making calls.



► Press the multifunction button twice.

Press	Function	Voice prompt
	 Redials the last number called	“redialing”
	 Cancels redialing	“call ended”

## Voice control function

You can use this function when the headphones are not used for making calls.

1. Press the multifunction button three times.

Press	Function	Voice prompt
	 Starts voice control	“voice dialing“

2. Say your voice command, such as “Call Jane”.  
The **Bluetooth** smartphone calls Jane.

## Care and maintenance

### CAUTION

Liquids can damage the electronics of the product!



Liquids entering the housing of the product can cause a short-circuit and damage the electronics.

- ▶ Keep all liquids away from this product.
- ▶ Do not use any solvents or cleaning agents.

### Changing ear adapters and ear fins

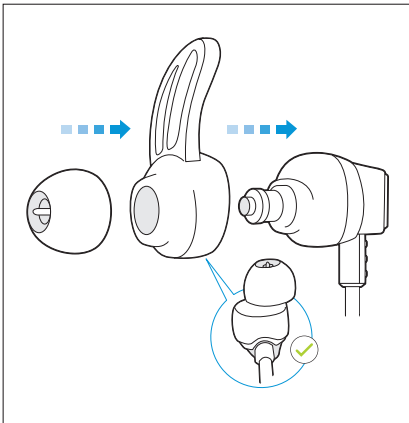

You can change ear adapters and ear fins to ensure that your CX SPORT stays in place even during intense workouts. Different sizes of ear adapters and ear fins are included in the package. Try each size and select the size that perfectly fits your ears.

1. Lightly pull the ear adapter away from the in-ear sound tunnel until it is completely detached.
2. Pull off the ear fin away from the earphones.
3. Secure the new ear fin. Ensure that the L ear fin is placed into the left earphone and the R into the right.
4. Insert the ear adapter by pushing it back onto the in-ear sound tunnel. Ensure that it completely locks into place.

### Cleaning the in-ear headphones

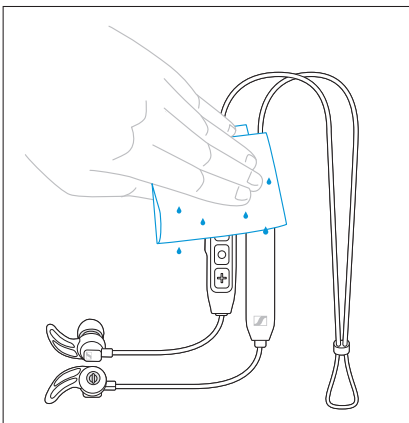

Primarily, clean the in-ear headphones with a soft, dry cloth. If they have been used during work outs, clean them with a soft cloth dampened in water.

## **Storage and handling**

To keep the headphones in good condition and to avoid nicks and scratches, always store the headphones in the carry case when not in use or when carrying them around.

### **Information about the rechargeable battery**

Sennheiser ensures and guarantees that the battery performs at the optimum upon purchase of the headphones. Upon purchase or within the warranty period, if you suspect that the battery is obviously defective, please immediately return the headphones to any Sennheiser service partner.

## Troubleshooting

Problem	Possible cause	Possible solution	Page
Headphones cannot be switched on	Battery is empty	Charge the headphones.	13
No audio signal	Headphones are not paired with your device	Check if the headphones are paired. If necessary, pair the headphones with your device again.	14
	Volume too low	Increase the volume.	19
	Headphones are switched off	Switch the headphones on.	17
Headphones cannot connect	Smartphone is switched off	Switch your smartphone on.	
	Bluetooth is deactivated on your smartphone	Activate <b>Bluetooth</b> on your smartphone.	
Headphones do not respond to any button press	Function of the headphones is faulty	Clear the pairing settings from the headphones, and pair again.	30

If you encounter a problem that is not listed in the table, or if the solutions provided do not work, please contact an authorized Sennheiser service partner for assistance.

To find a Sennheiser service partner in your country, visit [www.sennheiser.com](http://www.sennheiser.com).

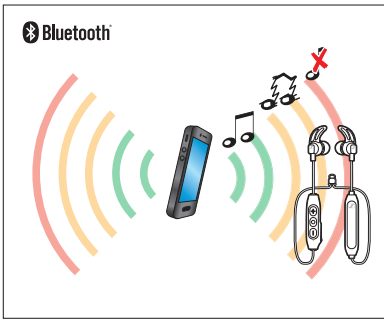

### Leaving the Bluetooth transmission range

Wireless calling and streaming are only possible in the **Bluetooth** transmission range of your smartphone. The transmission range largely depends on environmental conditions such as wall thickness, wall composition etc. With a free line of sight, the transmission range of most smartphones and **Bluetooth** devices is up to 10 meters.

If the headphones leave the **Bluetooth** transmission range of the smartphone, the sound quality deteriorates and you hear the voice prompt “lost connection”. At this point, the connection breaks down completely. You can re-establish the connection if you re-enter the **Bluetooth** transmission range and you hear the voice prompt ”connected”.

- To re-establish the connection, press the multifunction button.

### Clearing previously paired devices

1. Set the headphones to pairing mode, see page 14.  
The LED flashes blue and red. The headphones are in pairing mode.
2. Press the Volume/track + button for 2 seconds.  
The LED flashes purple 3 times. The headphones are permanently disconnected from all devices and immediately go into pairing mode.

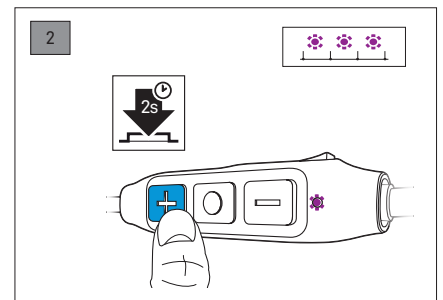
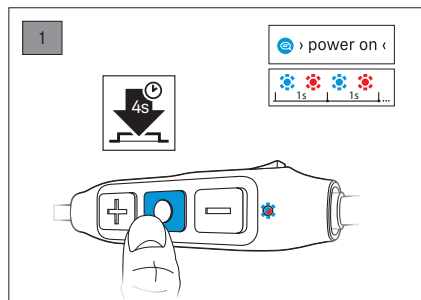



## Specifications

### CX SPORT In-Ear Wireless headphones

Ear coupling	ear canal
Frequency response	17 - 21,000 Hz
Transducer principle	dynamic
Sound pressure level (SPL)	112 dB (passive: 1 kHz/ 0 dBFS)
THD (1 kHz, 100 dB)	< 0.5 %
Pick-up pattern (speech audio)	omni-directional
Input power	3.7 V <sup>DC</sup> , 100 mAh: built-in rechargeable lithium-polymer battery 5 V <sup>DC</sup> , 500 mA: USB charging
Operating time	Up to 6 hours (A2DP)/ 8.5 hours (HFP)
Temperature range	operation: 0 to 40°C/32 to 104°F storage: -25 to 70°C/-13 to 158°F
Maximal value of static magnetic field at the surface	3.6 mT
Charging time	1.5 hours
Weight	approx. 15 g



### Bluetooth

Version	4.2, class 1
Transmission frequency	2402 – 2480 MHz
Modulation type	GFSK, $\pi/4$ DQPSK
Profiles	HFP, AVRCP, A2DP
RF output power	10 mW (max)
Supported codec	SBC, aptX, aptX LL

## Trademarks

The **Bluetooth**® word mark and logos are registered trademarks owned by **Bluetooth SIG, Inc.** and any use of such marks by Sennheiser electronic GmbH & Co. KG is under license.

Qualcomm aptX is a product of Qualcomm Technologies International, Ltd. Qualcomm is a trademark of Qualcomm Incorporated, registered in the United States and other countries, used with permission. aptX is a trademark of Qualcomm Technologies International, Ltd., registered in the United States and other countries, used with permission.

Other company and product names mentioned herein are trademarks of their respective owners.

---

**Sennheiser electronic GmbH & Co. KG**

Am Labor 1, 30900 Wedemark, Germany  
[www.sennheiser.com](http://www.sennheiser.com)

Publ. 04/18, A01