



**MF525x / MF522x**

# **User's Guide**

# Contents

<b>Setting Up</b> .....	3
<b>Main Functions</b> .....	4
<b>Preparations Required Before Use</b> .....	6
<b>Preventing Unauthorized Access</b> .....	8
<b>Setting Up Using the Setup Guide</b> .....	10
<b>Setting the Date/Time</b> .....	12
<b>Setting Up the Network Environment</b> .....	14
Selecting Wired LAN or Wireless LAN .....	16
Connecting to a Wired LAN .....	17
Connecting to a Wireless LAN .....	18
Setting Up Connection Using WPS Push Button Mode .....	20
Setting Up Connection Using WPS PIN Code Mode .....	22
Setting Up Connection by Selecting a Wireless Router .....	24
Setting Up Connection by Specifying Detailed Settings .....	27
Checking the SSID and Network Key .....	30
Setting IP Addresses .....	31
Setting IPv4 Address .....	32
Setting IPv6 Addresses .....	35
Viewing Network Settings .....	38
Configuring Settings for Communication with a Computer .....	40
Configuring Printing Protocols and WSD Functions .....	41
Configuring Printer Ports .....	44
Setting Up Print Server .....	48
Configuring the Machine for Your Network Environment .....	51
Configuring Ethernet Settings .....	52
Changing the Maximum Transmission Unit .....	54
Setting a Wait Time for Connecting to a Network .....	55
Configuring DNS .....	56
Configuring SMB .....	60
Configuring WINS .....	62
Registering LDAP Servers .....	64
Monitoring and Controlling the Machine with SNMP .....	69
Other Network Settings .....	73
<b>Installing Drivers</b> .....	78
<b>Configuring Initial Settings for Fax Functions</b> .....	79
Deciding Which Fax Receive Mode to Use .....	80
Registering the Fax Number and Unit Name .....	81
Selecting the Receive Mode .....	82
Connecting the Telephone Line .....	83
<b>Configuring Scan Settings</b> .....	84
Preparing to Use the Machine as a Scanner .....	85
Procedure for Setting to Send E-Mail/Send and Receive I-Fax .....	86
Configuring Basic E-Mail Settings .....	87

Configuring E-Mail/I-Fax Communication Settings .....	90
Procedure for Setting a Shared Folder as a Save Location .....	94
Setting a Shared Folder as a Save Location .....	95
Procedure for Setting a FTP Server as a Save Location .....	98

## **Basic Operations** ..... 101

<b>Parts and Their Functions</b> .....	105
Front Side .....	106
Back Side .....	108
Interior .....	109
Feeder .....	110
Multi-Purpose Tray .....	111
Paper Drawer .....	112
Operation Panel .....	113
<b>Turning ON the Machine</b> .....	115
Turning OFF the Machine .....	116
Powering OFF at a Fixed Time .....	117
<b>Using the Operation Panel</b> .....	119
Basic Screens .....	120
Home Screen .....	121
<Status Monitor> Screen .....	124
Message Display .....	126
Basic Operation .....	127
Entering Text .....	130
<b>Logging in to the Machine</b> .....	132
<b>Placing Originals</b> .....	134
<b>Loading Paper</b> .....	138
Loading Paper in the Paper Drawer .....	140
Loading Paper in the Multi-Purpose Tray .....	145
Loading Envelopes .....	148
Loading Preprinted Paper .....	150
Specifying Paper Size and Type .....	154
Specifying Paper Size and Type in the Paper Drawer .....	155
Specifying Paper Size and Type in the Multi-Purpose Tray .....	157
Registering Default Paper Settings for the Multi-Purpose Tray .....	159
Registering a Custom Paper Size .....	161
Limiting the Paper Sizes Displayed .....	162
Automatically Selecting an Appropriate Paper Source for Each Function .....	163
<b>Customizing the Display</b> .....	164
Customizing the Home Screen .....	165
Registering Frequently Used Settings .....	168
<b>Changing the Default Settings for Functions</b> .....	170
<b>Setting Sounds</b> .....	172
<b>Entering Sleep Mode</b> .....	174
<b>Registering Destinations</b> .....	176

Registering Destinations in the Address Book .....	178
Registering Multiple Destinations as a Group .....	181
Editing the Registered Destinations in the Address Book .....	183
<b>Using a USB Memory Device .....</b>	<b>184</b>

## **Copying .....** 187

<b>Copy Basic Features Screen .....</b>	<b>189</b>
<b>Basic Copy Operations .....</b>	<b>191</b>
Canceling Copies .....	196
Checking the Copying Status and Log .....	197
<b>Enhancing and Adjusting Copy Quality .....</b>	<b>199</b>
Selecting the Type of Original for Copying .....	200
Adjusting Sharpness for Copying (Sharpness) .....	201
Erasing Dark Borders When Copying (Erase Frame) .....	202
<b>Useful Copy Functions .....</b>	<b>203</b>
Copying Multiple Documents onto One Sheet (N on 1) .....	204
Collating Copies by Page .....	205
Making ID Card Copies .....	206
Making Passport Copies .....	207

## **Faxing .....** 210

<b>Fax Basic Features Screen .....</b>	<b>213</b>
<b>Basic Operations for Sending Faxes .....</b>	<b>214</b>
Canceling Sending Faxes .....	222
<b>Receiving Faxes .....</b>	<b>223</b>
<b>Useful Functions When Sending .....</b>	<b>226</b>
Recalling Previously Used Settings for Sending (Recall Settings) .....	227
Sending a Fax after a Phone Call (Manual Sending) .....	230
Saving a Copy of a Sent Original .....	232
<b>Various Receiving Methods .....</b>	<b>233</b>
Saving Received Documents into the Machine (Memory Reception) .....	234
<b>Forwarding the Received Documents Automatically .....</b>	<b>236</b>
<b>Checking Status and Log for Sent and Received Documents .....</b>	<b>238</b>
<b>Sending Faxes from Your Computer (PC Fax) .....</b>	<b>240</b>
Sending PC Faxes .....	241
<b>Using Internet Fax (I-Fax) .....</b>	<b>243</b>
Sending I-Faxes .....	244
Receiving I-Faxes .....	251

## **Printing .....** 253

<b>Printing from a Computer .....</b>	<b>254</b>
Canceling Prints .....	256
Checking the Printing Status and Log .....	258
<b>Various Printing Methods .....</b>	<b>260</b>

Printing a Document Secured by a PIN (Secure Print) .....	261
Printing via Secure Print .....	262
Printing from a USB Memory Device (Memory Media Print) .....	265

## Scanning ..... 274

<b>Scan Basic Features Screen</b> .....	276
<b>Basic Operations for Scanning Originals</b> .....	279
Scanning and Saving to a Computer .....	280
Saving Data to a USB Memory Device .....	282
Sending Data by E-Mail/Saving Data to a Shared Folder or FTP Server .....	286
Canceling Sending Documents .....	295
Checking Status and Log for Scanned Originals .....	296
<b>Scanning Clearly</b> .....	298
Adjusting Image Quality .....	299
Adjusting Density .....	300
Adjusting Sharpness When Scanning (Sharpness) .....	301
<b>Useful Scanning Functions</b> .....	303
Enhancing the Security of Electronic Files .....	304
Adjusting Balance between File Size and Image Quality (Data Size) .....	307
Recalling Previously Used Settings for Sending/Saving (Recall Settings) .....	308
Specifying E-Mail Settings .....	311
<b>Using Your Computer to Scan (Remote Scan)</b> .....	314
Scanning Documents from an Application .....	315
Using ScanGear MF .....	317

## Linking with Mobile Devices ..... 319

<b>Connecting with Mobile Devices</b> .....	320
Connecting via a Wireless LAN Router (LAN Connection) .....	321
Connecting Directly (Access Point Mode) .....	323
<b>Utilizing the Machine through Applications</b> .....	327
<b>Using AirPrint</b> .....	328
Printing with AirPrint .....	333
Scanning with AirPrint .....	336
Faxing with AirPrint .....	338
If AirPrint Cannot Be Used .....	340
<b>Using Google Cloud Print</b> .....	341
<b>Managing the Machine by the Remote Control</b> .....	343

## Managing the Machine ..... 346

<b>Setting Access Privileges</b> .....	348
Setting the System Manager ID and PIN .....	349
Setting the Department ID Management .....	351
Setting a Remote UI PIN .....	357
LDAP Server Authentication .....	359

<b>Configuring the Network Security Settings</b> .....	363
Restricting Communication by Using Firewalls .....	365
Specifying IP Addresses for Firewall Settings .....	366
Specifying MAC Addresses for Firewall Settings .....	369
Changing Port Numbers .....	372
Setting a Proxy .....	374
Configuring the Key and Certificate for TLS .....	376
Generating the Key and Certificate for Network Communication .....	379
Generating a Key and Certificate Signing Request (CSR) .....	382
Registering the Key and Certificate for Network Communication .....	385
Configuring IPSec Settings .....	387
Configuring IEEE 802.1X Authentication Settings .....	394
<b>Restricting the Machine's Functions</b> .....	398
Restricting Access to Address Book and Sending Functions .....	400
Restricting Use of the Address Book .....	401
Limiting Available Destinations .....	403
Restricting the Fax Sending Functions .....	405
Restricting Printing from a Computer .....	407
Restricting USB Functions .....	408
Disabling HTTP Communication .....	410
Disabling Remote UI .....	411
<b>Increasing the Security of Documents</b> .....	412
Generating a Device Signature Key .....	413
<b>Managing the Machine from a Computer (Remote UI)</b> .....	414
Starting Remote UI .....	415
Checking the Status and Logs .....	418
Setting Up Menu Options from Remote UI .....	424
Registering Destinations from Remote UI .....	427
Security Policy .....	431
Importing/Exporting the Setting Data .....	437
<b>Updating the Firmware</b> .....	440
<b>Initializing Settings</b> .....	442

## **Setting Menu List** ..... 445

<b>&lt;Preferences&gt;</b> .....	446
<Display Settings> .....	447
<English Keyboard Layout> .....	451
<Timer/Energy Settings> .....	452
<Network> .....	457
<External Interface> .....	471
<Accessibility> .....	472
<b>&lt;Adjustment/Maintenance&gt;</b> .....	473
<Adjust Image Quality> .....	474
<Maintenance> .....	482
<b>&lt;Function Settings&gt;</b> .....	483

<Common> .....	484
<Copy> .....	490
<Printer> .....	492
<Send> .....	517
<Receive/Forward> .....	529
<Store/Access Files> .....	536
<Secure Print> .....	542
<b>&lt;Set Destination&gt;</b> .....	543
<b>&lt;Management Settings&gt;</b> .....	544
<User Management> .....	545
<Device Management> .....	546
<License/Other> .....	550
<Data Management> .....	552
<Security Settings> .....	554

## **Maintenance** ..... 557

<b>Regular Cleaning</b> .....	559
Cleaning the Exterior .....	560
Cleaning the Platen Glass .....	561
Cleaning the Feeder .....	562
Cleaning the Fixing Assembly .....	565
<b>Replacing the Toner Cartridge</b> .....	566
<b>Checking the Remaining Amount of Consumables</b> .....	569
<b>Relocating the Machine</b> .....	570
<b>Adjusting Image Quality</b> .....	572
Adjusting the Gradation and Density for Copy Jobs .....	573
Adjusting Values for Text Color Reproducibility .....	575
Adjusting Print Density .....	577
Adjusting Print Position .....	578
<b>Viewing the Counter Value</b> .....	580
<b>Printing Reports and Lists</b> .....	581
<b>Consumables</b> .....	586

## **Troubleshooting** ..... 589

<b>Common Problems</b> .....	591
Installation/Settings Problems .....	592
Copying/Printing Problems .....	596
Faxing/Telephone Problems .....	599
<b>When You Cannot Print Properly</b> .....	601
Printing Results Are Not Satisfactory .....	603
Paper Creases or Curls .....	614
Paper Is Fed Incorrectly .....	616
<b>A Message or a Number Starting with "#" (an Error Code) Is Displayed</b> .....	617
Countermeasures for Each Message .....	618

Countermeasures for Each Error Code .....	632
<b>Clearing Paper Jams</b> .....	642
Paper Jams in the Feeder .....	644
Paper Jams in the Main Unit .....	646
Paper Jams in a Paper Source .....	652
<b>When a Problem Cannot Be Solved</b> .....	654

## **Appendix** ..... 656

<b>Third Party Software</b> .....	658
<b>Feature Highlights</b> .....	659
Going Green and Saving Money .....	660
Improving Efficiency .....	662
Going Digital .....	664
So Much More .....	666
<b>Specifications</b> .....	668
Main Unit .....	669
Feeder .....	672
Available Paper .....	673
Paper Feeder PF-C .....	676
Copy Card Reader-F .....	677
Fax Function .....	678
Scan Function .....	679
Printer Functions .....	680
Management Functions .....	682
System Environment .....	684
Network Environment .....	686
<b>Options</b> .....	687
Optional Equipment .....	688
System Options .....	690
<b>Manuals and Their Contents</b> .....	692
<b>Using User's Guide</b> .....	693
Screen Layout of User's Guide .....	694
Viewing User's Guide .....	697
<b>Basic Windows Operations</b> .....	698
<b>Notice</b> .....	706



# Setting Up

<b>Setting Up</b> .....	3
<b>Main Functions</b> .....	4
<b>Preparations Required Before Use</b> .....	6
<b>Preventing Unauthorized Access</b> .....	8
<b>Setting Up Using the Setup Guide</b> .....	10
<b>Setting the Date/Time</b> .....	12
<b>Setting Up the Network Environment</b> .....	14
Selecting Wired LAN or Wireless LAN .....	16
Connecting to a Wired LAN .....	17
Connecting to a Wireless LAN .....	18
Setting Up Connection Using WPS Push Button Mode .....	20
Setting Up Connection Using WPS PIN Code Mode .....	22
Setting Up Connection by Selecting a Wireless Router .....	24
Setting Up Connection by Specifying Detailed Settings .....	27
Checking the SSID and Network Key .....	30
Setting IP Addresses .....	31
Setting IPv4 Address .....	32
Setting IPv6 Addresses .....	35
Viewing Network Settings .....	38
Configuring Settings for Communication with a Computer .....	40
Configuring Printing Protocols and WSD Functions .....	41
Configuring Printer Ports .....	44
Setting Up Print Server .....	48
Configuring the Machine for Your Network Environment .....	51
Configuring Ethernet Settings .....	52
Changing the Maximum Transmission Unit .....	54
Setting a Wait Time for Connecting to a Network .....	55
Configuring DNS .....	56
Configuring SMB .....	60
Configuring WINS .....	62
Registering LDAP Servers .....	64
Monitoring and Controlling the Machine with SNMP .....	69
Other Network Settings .....	73
<b>Installing Drivers</b> .....	78
<b>Configuring Initial Settings for Fax Functions</b> .....	79
Deciding Which Fax Receive Mode to Use .....	80

## Setting Up

Registering the Fax Number and Unit Name .....	81
Selecting the Receive Mode .....	82
Connecting the Telephone Line .....	83
<b>Configuring Scan Settings</b> .....	<b>84</b>
Preparing to Use the Machine as a Scanner .....	85
Procedure for Setting to Send E-Mail/Send and Receive I-Fax .....	86
Configuring Basic E-Mail Settings .....	87
Configuring E-Mail/I-Fax Communication Settings .....	90
Procedure for Setting a Shared Folder as a Save Location .....	94
Setting a Shared Folder as a Save Location .....	95
Procedure for Setting a FTP Server as a Save Location .....	98

# Setting Up

---

261J-000

Before using the functions of the machine, the environmental conditions must be set in advance. To begin with, check the sequences of flow required to complete the setup, and then perform the actual settings. **▶Preparations Required Before Use(P. 6)**

## NOTE

- The functions installed on the machine vary depending on the model you purchased. Before using the machine, see **▶Main Functions(P. 4)** and check the available functions.

### Configuring Initial Settings of the Machine (Setup Guide)

- You can easily configure the initial settings required to use the machine, such as date, time, and network settings, by following the on-screen guidance. **▶Setting Up Using the Setup Guide(P. 10)**

## Main Functions

261J-001

This manual covers all the functions of the model series you purchased. Before getting started, check which functions are available on the model you purchased.

✓ : With function    — : Without function

Function	MF525x	MF522x
Copy	✓	✓
Fax	✓	—
Print	✓	✓
Scan	✓	✓
Feeder 2-sided scanning	✓	✓
2-sided printing	✓	✓
Wireless LAN	✓	✓
NFC	✓	—
Default System Manager ID	7654321	7654321
Default System Manager PIN	7654321	7654321
Application Library	✓	✓
Paper Feeder PF-C *	✓	✓
TELEPHONE 6 KIT *	✓	—
Copy Card Reader-F *	✓	✓
Barcode Printing Kit *	✓	✓
Send PDF Security Feature Set *	✓	✓

\*This is an optional item.

### NOTE

- For the available driver types, see the User Software CD-ROM/DVD-ROM supplied with the machine, or see the Canon website (<http://www.canon.com/>).

### LINKS

 **Viewing User's Guide(P. 697)**

## Preparations Required Before Use

261J-002

Set up the machine following steps 1 to 5 in order. For more information about a particular step, click on the link to go to the corresponding section. In addition, to use the machine safely, also check [▶Preventing Unauthorized Access\(P. 8\)](#) .

### Step 1

#### [▶Setting Up Using the Setup Guide\(P. 10\)](#)



### Step 2

#### [▶Setting Up the Network Environment\(P. 14\)](#)

- Configure the network settings that are not covered in the Setup Guide. If you do not need to use the Setup Guide, configure the network settings from here.



### Step 3

#### [▶Installing Drivers\(P. 78\)](#)



### Step 4

#### [▶Configuring Initial Settings for Fax Functions\(P. 79\)](#)



### Step 5

#### [▶Configuring Scan Settings\(P. 84\)](#)



## TIPS

### Setting from the Remote UI

- When the network environment settings are complete, you can efficiently set the machine from a computer using Remote UI. ▶ **Starting Remote UI(P. 415)**

### Importing data from another machine to save time

- As long as the model is the same, you can save setting data registered on another Canon printer/multifunction machine to a computer (export) and load the setting data to this machine (import). ▶ **Importing/Exporting the Setting Data(P. 437)**

# Preventing Unauthorized Access

261J-003

This section describes the security measures on how to prevent unauthorized access from the external network. This is a must-read for all users and administrators before using this machine, other printers, and multifunction machines connected to the network. In recent years, a printer/multifunction machine connected to the network can offer you a variety of useful functions, such as printing from a computer, operating from a computer using the remote function, and sending scanned documents via the Internet. On the other hand, it is essential to take security measures to reduce the security risk for information leakage, as a printer/multifunction machine has become more exposed to threats, such as unauthorized access and theft, when it is connected to the network. This section explains necessary settings you need to specify to prevent unauthorized access before using a printer/multifunction machine connected to the network.

## Security Measures to Prevent Unauthorized Access from the External Network

- ▶ **Assigning a Private IP Address(P. 8)**
- ▶ **Using Firewall to Restrict Transmission(P. 9)**
- ▶ **Specifying the TLS Encrypted Communication (P. 9)**
- ▶ **Setting PIN to Manage Information Stored in the Multifunction Machine(P. 9)**

### Assigning a Private IP Address

An IP address is a numerical label assigned to each device participating in a computer network. A "global IP address" is used for the communication connecting to the Internet, and a "private IP address" is used for the communication within a local area network, such as a LAN in the company. If a global IP address is assigned, your printer/multifunction machine is open to the public and can be accessed via the Internet. Thus, the risk of information leakage due to unauthorized access from external network increases. On the other hand, if a private IP address is assigned, your printer/multifunction machine is closed to a local area network and can be accessed by only users on your local area network, such as a LAN in the company.

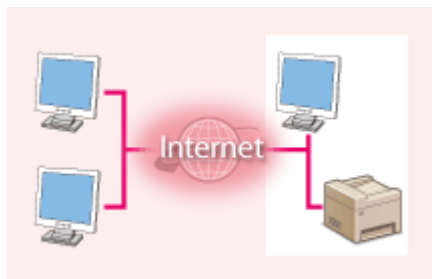

**Global IP Address**

Can be accessed from the external network

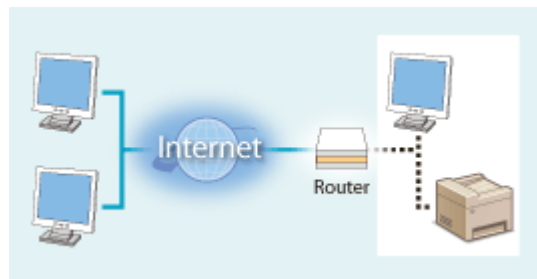

**Private IP Address**

Can be accessed from the users within a local area network

Basically, assign a private IP address to your printer/multifunction machine. Make sure to confirm the IP address, assigned to the printer/multifunction machine you are using, is a private IP address or not. A private IP address is found in one of the following ranges.

#### ■ Ranges for Private IP addresses

- From 10.0.0.0 to 10.255.255.255
- From 172.16.0.0 to 172.31.255.255
- From 192.168.0.0 to 192.168.255.255

For information on how to confirm the IP address, see ▶ **Setting IPv4 Address(P. 32)** .

### NOTE

- If a global IP address is assigned to a printer/multifunction machine, you can create a network environment to reduce the risk of unauthorized access by installing security software, such as a firewall that prevents



access from the external networks. If you want to assign a global IP address to and use a printer/multifunction machine, contact your network administrator.

## Using Firewall to Restrict Transmission

A firewall is a system that prevents unauthorized access from the external networks and protects against attacks/intrusions to a local area network. You can use a firewall on your network environment to block access from the external network that appears to be dangerous, by restricting communication from specified IP address of the external network. The function installed to a Canon printer/multifunction machine enables you to set up the IP address filter. For information on how to set up an IP address filter, see [▶Specifying IP Addresses for Firewall Settings\(P. 366\)](#) .

## Specifying the TLS Encrypted Communication

For information on the TLS Encrypted Communication, see [▶Configuring the Network Security Settings\(P. 363\)](#) , and on the procedures to specify, see [▶Configuring the Key and Certificate for TLS\(P. 376\)](#) .

## Setting PIN to Manage Information Stored in the Multifunction Machine

If a malicious third party attempts to gain unauthorized access to a printer/multifunction machine, setting PIN to information stored in the machine will reduce the risk of information leakage. Canon printers/multifunction machines enable you to protect various type of information by setting PIN.

### ■Setting PIN to Each Function

- Setting PIN for Using Remote UI  
For more information, see [▶Setting a Remote UI PIN\(P. 357\)](#) .
- Setting PIN for the System Manager Settings  
For more information, see [▶Setting the System Manager ID and PIN\(P. 349\)](#) .
- Address Book PIN  
For more information on setting a PIN, see [▶Restricting Use of the Address Book\(P. 401\)](#) .

Listed above are some examples of security measures for preventing unauthorized access. For more information on the other security measures, see [▶Managing the Machine\(P. 346\)](#) and take necessary security measures for preventing unauthorized access to suit your environment.

# Setting Up Using the Setup Guide

261J-004

When the machine is turned on ( **Turning ON the Machine(P. 115)** ) for the first time, the Setup Guide starts up to assist you to configure the initial settings of the machine by following the on-screen guidance. In the Setup Guide, the setting screens are displayed in the following order.

## Step 1 Setting the Display Language and the Country or Region

Set the language to be displayed on the operation panel screen or in reports, as well as the country or region where the machine will be used.

- 1 Select a language.
- 2 Select <Yes>.
- 3 Select a country or region.

## Step 2 Setting the Date and Time

Adjust the machine's date/time.

- 1 Select a time zone.

### NOTE:

#### What is UTC?

- Coordinated Universal Time (UTC) is the primary time standard by which the world regulates clocks and time. The correct UTC time zone setting is required for Internet communications.

- 2 Enter the date and time, and select <Apply>.
  - Tap the entry field, and enter the date and time.

## Step 3 Setting the Access Security Measures

Set a PIN to access the Remote UI. Because the Remote UI can be used to change the machine settings from a computer, setting of a PIN is recommended.

- 1 Select <Yes>.
  - If you select <No>, PIN is not set, and the Setup Guide proceeds to step 4.
  - You can also set the access security measure of the Remote UI later. **Setting a Remote UI PIN(P. 357)**
- 2 Enter a PIN, and then select <Apply>.
- 3 Enter the same PIN, and then select <Apply>.

## Step 4 Setting the Wireless LAN

Configure the settings to connect to the network using the wireless LAN.

- 1 Select <Yes>.
  - If you select <No>, wireless LAN is not set, and the Setup Guide proceeds to step 5.
- 2 Select <OK>.
- 3 Select the setting method.

- For more information about the wireless LAN settings, see [▶Connecting to a Wireless LAN\(P. 18\)](#) .

## Step 5

### Viewing Application Library

The one-touch button referred to as "Application Library" is provided in the Home screen. You can read the description of each function.

- 1 To finish the Setup Guide, select <End>.

⇒ When the Setup Guide is complete, the Home screen appears.

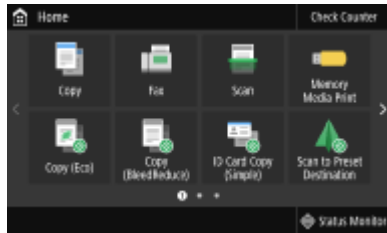

# Setting the Date/Time

261J-005

Set the date and time for the machine. The date and time are used as the reference for the functions specifying the time, therefore, they need to be set accurately.

- ▶ **Setting the Time Zone(P. 12)**
- ▶ **Setting the Current Date and Time(P. 12)**
- ▶ **Setting the Daylight Saving Time(P. 13)**

## Setting the Time Zone

If the time zone setting is changed, the values set in <Current Date/Time Settings> are also changed accordingly.

- 1** Select <Menu> in the Home screen. ▶ **Home Screen(P. 121)**
- 2** Select <Preferences> ▶ <Timer/Energy Settings> ▶ <Date/Time Settings> ▶ <Time Zone>.
- 3** Select the time zone.



## NOTE

### What is UTC?

- Coordinated Universal Time (UTC) is the primary time standard by which the world regulates clocks and time. Time differences exist depending on the country or area where the machine is used. The correct UTC time zone setting is required for Internet communications.

## Setting the Current Date and Time

- 1** Select <Menu> in the Home screen. ▶ **Home Screen(P. 121)**
- 2** Select <Preferences> ▶ <Timer/Energy Settings> ▶ <Current Date/Time Settings>.
- 3** Enter the date and time.
  - Tap the entry field, and enter the date and time.

## 4 Select <Apply>.

### IMPORTANT

- Set <Time Zone> before setting the current date and time. If the <Time Zone> setting is changed later, the current date and time are also changed accordingly.

### NOTE

- The display format of the date and time can be changed, respectively.
  - ▶<Date Format>(P. 453)
  - ▶<Time Format>(P. 453)

## Setting the Daylight Saving Time

If daylight saving time is enabled, specify the dates from which and to which daylight saving time is in effect.

### 1 Select <Menu> in the Home screen. ▶Home Screen(P. 121)

### 2 Select <Preferences> ▶ <Timer/Energy Settings> ▶ <Date/Time Settings> ▶ <Daylight Saving Time Settings>.

### 3 Select <Off> or <On> in <Daylight Saving Time>.

- When you select <On>, select <Start Date> and <End Date>, and set the month and day for each item. To set the day, specify "what day of which week."

### 4 Select <Apply>.

# Setting Up the Network Environment

261J-006

When connecting the machine to a wired or wireless local area network (LAN), you need to set an IP address unique to the selected network. Select "wired" or "wireless" depending on your communication environment and networking devices. For specific IP address settings, contact your Internet service provider or Network Administrator.

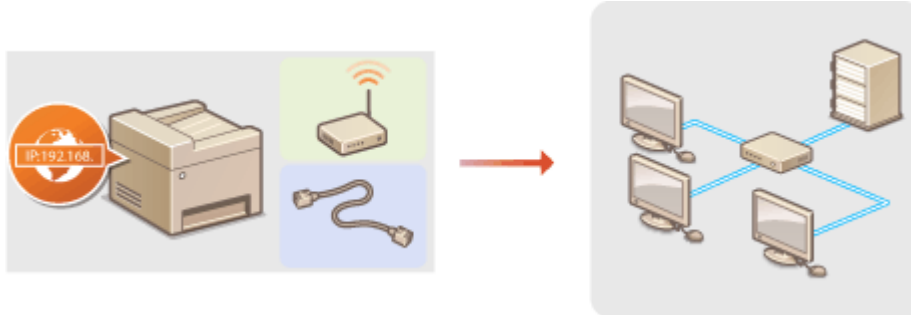

## IMPORTANT

- If the machine is connected to an unsecured network, your personal information might be leaked to a third party.

## NOTE

- The machine cannot connect to both wired and wireless LANs at the same time.
- The machine does not come with a LAN cable or router. Have them ready as necessary.
- For more information about your networking devices, see the instruction manuals for the devices or contact your manufacturer.

### ■ Before You Start

Follow these steps to connect the machine to a network.



#### Check your computer settings.

- Make sure that the computer is correctly connected to the network. For more information, see the instruction manuals for the devices you are using, or contact the device manufacturers.
- Make sure that the network settings have been completed on the computer. If the network has not been set up properly, you will not be able to use the machine on the network, even if you perform the rest of the procedure below.

#### NOTE:

- Depending on the network, you may need to change settings for the communication method or the Ethernet type ( [▶Configuring Ethernet Settings\(P. 52\)](#) ). For more information, contact your Internet service provider or Network Administrator.
- To check the MAC address of the machine.
  - ▶[Viewing the MAC Address for Wired LAN\(P. 38\)](#)
  - ▶[Viewing the MAC Address and Information for Wireless LAN\(P. 39\)](#)

- To connect to an IEEE 802.1X network, see [▶Configuring IEEE 802.1X Authentication Settings\(P. 394\)](#) .



2



**Select wired or wireless LAN.**

- ▶[Selecting Wired LAN or Wireless LAN\(P. 16\)](#)



3



**Connect to a wired or wireless LAN.**

- Proceed to the section that corresponds to the setting you selected in step 2.
  - ▶[Connecting to a Wired LAN\(P. 17\)](#)
  - ▶[Connecting to a Wireless LAN\(P. 18\)](#)



4



**Set the IP address as necessary.**

- At the time of purchase, the machine is set to automatically acquire an IP address. Change this setting if you want to use a specific IP address. ▶[Setting IP Addresses\(P. 31\)](#)

LINKS

---

- ▶[Configuring Settings for Communication with a Computer\(P. 40\)](#)
- ▶[Configuring the Machine for Your Network Environment\(P. 51\)](#)

# Selecting Wired LAN or Wireless LAN

---

261J-007

After you decide on wired or wireless LAN to connect the machine to the computer, select wired LAN or wireless LAN using the operation panel. Note that if you change the setting from <Wired LAN> to <Wireless LAN> or vice versa, you will need to uninstall the drivers installed on your computer and then reinstall them. For more information, see the manuals for the relevant drivers on the online manual website.

**1** Select <Menu> in the Home screen.  **Home Screen(P. 121)**

**2** Select <Preferences>  <Network>.

- If the login screen appears, enter the correct ID and PIN.  **Logging in to the Machine(P. 132)**

**3** Select <Select Wired/Wireless LAN>.

**4** Select <Wired LAN> or <Wireless LAN>.

## LINKS

---

-  **Setting Up the Network Environment(P. 14)**
-  **Connecting to a Wired LAN(P. 17)**
-  **Connecting to a Wireless LAN(P. 18)**



## Connecting to a Wired LAN

261J-008

Connect the machine to a computer via a router. Use a LAN cable to connect the machine to the router.

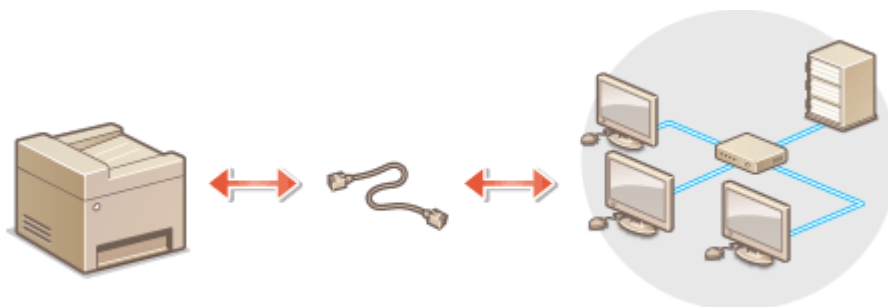

### 1 Connect a LAN cable.

- Connect the machine to a router by using a LAN cable.
- Push the connector in until it clicks into place.

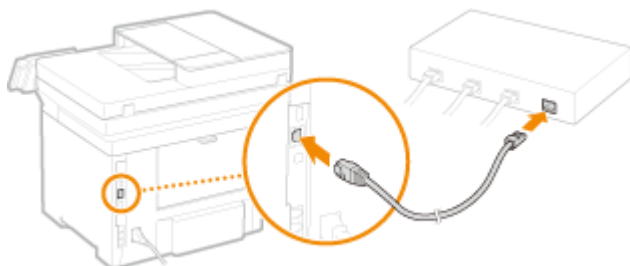

### 2 Wait for several minutes.

⇒ The IP address is set automatically.

#### NOTE:

- You can set the IP address manually. [▶Setting IP Addresses\(P. 31\)](#)

#### LINKS

[▶Setting Up the Network Environment\(P. 14\)](#)

## Connecting to a Wireless LAN

261J-009

Wireless routers (or access points) connect the machine to a computer via radio waves. If your wireless router is equipped with Wi-Fi Protected Setup (WPS), configuring your network is automatic and easy. If your networking devices do not support automatic configuration, or if you want to specify authentication and encryption settings in detail, you need to manually set up the connection. Make sure that your computer is correctly connected to the network.

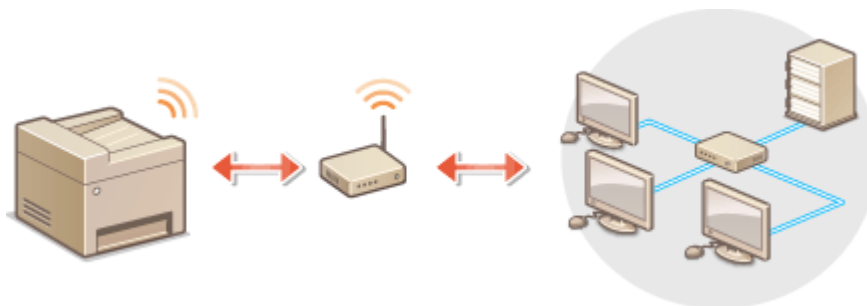

▶ **Setting Up Connection Using WPS(P. 18)**

▶ **Manually Setting Up Connection(P. 19)**

### IMPORTANT

#### Risk of information leak

- Use wireless LAN connection at your own discretion and at your own risk. If the machine is connected to an unsecured network, your personal information might be leaked to a third party because radio waves used in wireless communication can go anywhere nearby, even beyond walls.

#### Wireless LAN security

- The wireless LAN function of this machine supports WEP, WPA-PSK, and WPA2-PSK. For the wireless security compatibility of your wireless router, see the instruction manuals for your networking devices or contact your manufacturer.

### NOTE

#### Required devices for wireless LAN connection

- The machine does not come with a wireless router. Have the router ready as necessary.

### Setting Up Connection Using WPS

When using WPS, two modes are available: push button mode and PIN code mode.

#### ■ Push Button Mode

Find the WPS mark shown below on the package of your wireless router. Also make sure that there is a WPS button on your networking device. ▶ **Setting Up Connection Using WPS Push Button Mode(P. 20)**



## ■ PIN Code Mode

Some WPS routers do not support the push button mode. If WPS PIN code mode is mentioned on the package or in the instruction manuals of your networking device, set up the connection by entering the PIN code. [▶Setting Up Connection Using WPS PIN Code Mode\(P. 22\)](#)

## NOTE

- If the wireless router is set to use WEP authentication, you may not be able to set up connection using WPS.

## Manually Setting Up Connection

When manually setting up a wireless connection, you can either select a wireless router or manually enter the required information. Regardless of the method, make sure that you have the required setup information, including the SSID and network key. [▶Checking the SSID and Network Key\(P. 30\)](#)

### ■ Selecting a Wireless Router

Select this setup option if you need to manually set up the connection but want to complete the setup as easily as possible. [▶Setting Up Connection by Selecting a Wireless Router\(P. 24\)](#)

### ■ Manually Entering the Setup Information

If you want to specify security settings in detail, such as authentication and encryption settings, manually enter the SSID and network key to set up the connection. [▶Setting Up Connection by Specifying Detailed Settings\(P. 27\)](#)

## LINKS

---

[▶Setting Up the Network Environment\(P. 14\)](#)

[▶Selecting Wired LAN or Wireless LAN\(P. 16\)](#)

# Setting Up Connection Using WPS Push Button Mode

261J-00A

If your wireless router supports WPS push button mode, you can easily set up a connection with a WPS button.

## IMPORTANT

- How to operate the wireless router may vary on each device. See the instruction manuals for your networking device for help.

**1** Select <Menu> in the Home screen. **▶ Home Screen(P. 121)**

**2** Select <Preferences> ▶ <Network>.

- If the login screen appears, enter the correct ID and PIN. **▶ Logging in to the Machine(P. 132)**

**3** Select <Wireless LAN Settings>.

- If the <Do you want to enable the wireless LAN?> message is displayed, select <Yes>.

**4** Read the message that is displayed, and select <OK>.

**5** Select <WPS Push Button Mode>.

**6** Select <Yes>.

**7** Press and hold the WPS button on the wireless router.

- The button must be pressed within 2 minutes after selecting <Yes> in step 6.
- Depending on the networking device, you may need to press and hold the button for 2 seconds or longer. See the instruction manuals for your networking device for help.

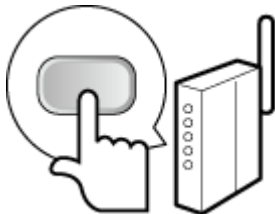

### NOTE:

If an error message is displayed during setup

- Select <Close> and return to step 5.

**8** Wait until message <Connected.> is displayed.

## 9 Select <Close>.

☞ Wait several minutes until the IP address and other items are set automatically.

### IMPORTANT:

#### Signal strength

- When more than one wireless router is available for connection, the machine connects to the device with the strongest signal. Signal strength is measured using RSSI (Received Signal Strength Indication).

### NOTE:

- You can set the IP address manually. ▶ **Setting IP Addresses(P. 31)**
- While the machine is connected to the wireless LAN, the Wi-Fi icon is displayed in the Home screen or the Basic Features screen of each function. ▶ **Basic Screens(P. 120)**

## NOTE

### Reducing power consumption

- You can set the machine to enter <Power Save Mode> based on signals emitted from the wireless router. ▶ **<Power Save Mode>(P. 458)**

### If the IP address of the machine has changed

- In a DHCP environment, the IP address of the machine may be changed automatically. If this happens, the connection is maintained as long as the machine and the computer belong to the same subnet.

## LINKS

---

- ▶ **Connecting to a Wireless LAN(P. 18)**

# Setting Up Connection Using WPS PIN Code Mode

261J-00C

If your wireless router supports WPS PIN code mode, generate a PIN code with the machine and register the code to the networking device.

## IMPORTANT

- How to operate the wireless router may vary on each device. See the instruction manuals for your networking device for help.



### From a Computer

#### 1 Access your wireless router from a computer and display the screen for entering a WPS PIN code.

- For more information, see the instruction manuals for your networking device.



### From the Operation Panel

#### 2 Select <Menu> in the Home screen. ▶ Home Screen(P. 121)

#### 3 Select <Preferences> ▶ <Network>.

- If the login screen appears, enter the correct ID and PIN. ▶ Logging in to the Machine(P. 132)

#### 4 Select <Wireless LAN Settings>.

- If the <Do you want to enable the wireless LAN?> message is displayed, select <Yes>.

#### 5 Read the message that is displayed, and select <OK>.

#### 6 Select <WPS PIN Code Mode>.

#### 7 Select <Yes>.

⇒ The PIN code is generated and shown on the display.



### From a Computer

#### 8 Register the generated PIN code to the wireless router.

- Register the PIN code on the setup screen displayed in step 1.

- The PIN code must be registered within 10 minutes after selecting <Yes> in step 7.

**NOTE:****If an error message is displayed during setup**

- Select <Close> and return to step 6.



## From the Operation Panel

**9 Wait until the message <Connected.> is displayed.****10 Select <Close>.**

⇒ Wait several minutes until the IP address and other items are set automatically.

**IMPORTANT:****Signal strength**

- When more than one wireless router is available for connection, the machine connects to the device with the strongest signal. Signal strength is measured using RSSI (Received Signal Strength Indication).

**NOTE:**

- You can set the IP address manually. ▶ **Setting IP Addresses(P. 31)**
- While the machine is connected to the wireless LAN, the Wi-Fi icon is displayed in the Home screen or the Basic Features screen of each function. ▶ **Basic Screens(P. 120)**

**NOTE****Reducing power consumption**

- You can set the machine to enter <Power Save Mode> based on signals emitted from the wireless router. ▶ **<Power Save Mode>(P. 458)**

**If the IP address of the machine has changed**

- In a DHCP environment, the IP address of the machine may be changed automatically. If this happens, the connection is maintained as long as the machine and the computer belong to the same subnet.

## LINKS

- ▶ **Connecting to a Wireless LAN(P. 18)**

## Setting Up Connection by Selecting a Wireless Router

261J-00E

You can search the wireless routers (or access points) available for connection and select one from the display of the machine. For the network key, enter a WEP key or PSK. Before selecting a wireless router, check and write down the required setup information, including the SSID and network key ( [▶Checking the SSID and Network Key\(P. 30\)](#) ).

### NOTE

#### Security settings

- If the wireless connection is set up by selecting a wireless router, the WEP authentication method is set to <Open System> or the WPA/WPA2 encryption method is set to <Auto> (AES-CCMP or TKIP). If you want to select <Shared Key> for WEP authentication or <AES-CCMP> for WPA/WPA2 encryption, you need to set up the connection using <Enter Manually>. [▶Setting Up Connection by Specifying Detailed Settings\(P. 27\)](#)

**1** Select <Menu> in the Home screen. [▶Home Screen\(P. 121\)](#)

**2** Select <Preferences> ▶ <Network>.

- If the login screen appears, enter the correct ID and PIN. [▶Logging in to the Machine\(P. 132\)](#)

**3** Select <Wireless LAN Settings>.

- If the <Do you want to enable the wireless LAN?> message is displayed, select <Yes>.

**4** Read the message that is displayed, and select <OK>.

**5** Select <SSID Settings>.

**6** Select <Select Access Point>.

▢ The machine starts searching for available wireless routers.

#### NOTE:

- If a message is displayed telling that access point cannot be found, see [▶Countermeasures for Each Message\(P. 618\)](#) .

**7** Select a wireless LAN router.

- Select the router whose SSID matches the one that you have written down, and select <Next>.



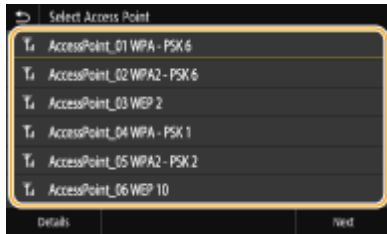

## NOTE:

### To view details of security settings

- Select the wireless LAN router, and select <Details>. To return to the original screen, select .

### If your wireless router is not found

- Check whether the machine is properly installed and ready to connect to the network. [▶Installation/Settings Problems\(P. 592\)](#)

## 8 Enter the network key that you have written down.

- Enter the network key, and select <Apply>.
- On how to enter text, see [▶Entering Text\(P. 130\)](#) .

## 9 Select <Yes>.

## NOTE:

### If an error message is displayed during setup

- Select <Close>, check whether the network key is correct, and return to step 5.

## 10 Wait until message <Connected.> is displayed.

## 11 Select <Close>.

⇒ Wait several minutes until the IP address and other items are set automatically.

## IMPORTANT:

### Signal strength

- When more than one wireless router is available for connection, the machine connects to the device with the strongest signal. Signal strength is measured using RSSI (Received Signal Strength Indication).

## NOTE:

- You can set the IP address manually. [▶Setting IP Addresses\(P. 31\)](#)
- While the machine is connected to the wireless LAN, the Wi-Fi icon is displayed in the Home screen or the Basic Features screen of each function. [▶Basic Screens\(P. 120\)](#)

## NOTE

### Reducing power consumption

- You can set the machine to enter <Power Save Mode> based on signals emitted from the wireless router. [▶<Power Save Mode>\(P. 458\)](#)

### If the IP address of the machine has changed

- In a DHCP environment, the IP address of the machine may be changed automatically. If this happens, the connection is maintained as long as the machine and the computer belong to the same subnet.

### LINKS

---

▶ **Connecting to a Wireless LAN(P. 18)**

# Setting Up Connection by Specifying Detailed Settings

261J-00F

If you want to specify the security settings in detail or cannot establish the wireless connection using the other procedures, manually enter all the required information for the wireless LAN connection. Before specifying detailed settings, check and write down the required information, including the SSID, network key, and wireless security protocols. [▶Checking the SSID and Network Key\(P. 30\)](#)

**1** Select <Menu> in the Home screen. [▶Home Screen\(P. 121\)](#)

**2** Select <Preferences> ▶ <Network>.

- If the login screen appears, enter the correct ID and PIN. [▶Logging in to the Machine\(P. 132\)](#)

**3** Select <Wireless LAN Settings>.

- If the <Do you want to enable the wireless LAN?> message is displayed, select <Yes>.

**4** Read the message that is displayed, and select <OK>.

**5** Select <SSID Settings> ▶ <Enter Manually>.

**6** Enter the SSID that you have written down.

- Enter the SSID, and select <Apply>.
- On how to enter text, see [▶Entering Text\(P. 130\)](#) .

**7** Specify the security settings based on the information that you have written down.

- If you do not need to specify the security settings, select <None>.

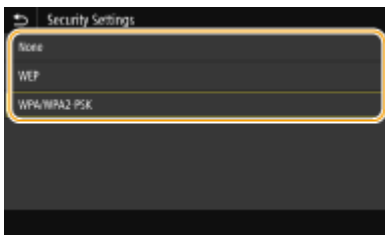

## ■ Using WEP

- 1** Select <WEP>.
- 2** Select an authentication method.

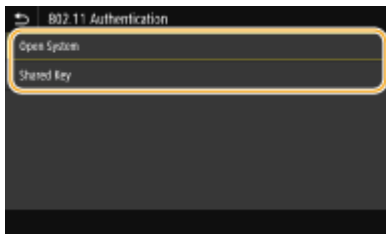

### <Open System>

Sets open system authentication, which is also called "open authentication."

### <Shared Key>

Uses the WEP key as a password.

## NOTE:

### When <Open System> is selected

- When connecting to a wireless LAN, the machine experiences an authentication error if the shared key authentication is set on the wireless router. If this happens, the machine automatically changes the setting to <Shared Key> and retries the connection.

- 3 Select the WEP key you want to edit.
  - Select the WEP key (1 to 4), and select <Edit>.
  - Up to four WEP keys can be registered.
- 4 Enter the network key that you have written down.
  - Enter the network key, and select <Apply>.
- 5 Select the desired WEP key.
  - Select the WEP key you have edited, and select <Register>.

## ■ Using WPA-PSK or WPA2-PSK

- 1 Select <WPA/WPA2-PSK>.
- 2 Select an encryption method.

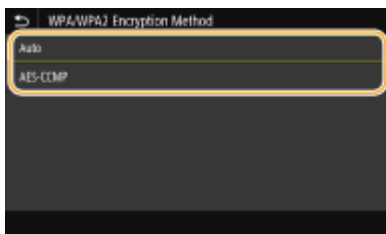

### <Auto>

Sets the machine to automatically select AES-CCMP or TKIP to match the setting of the wireless router.

### <AES-CCMP>

Sets AES-CCMP as the encryption method.

- 3 Enter the network key that you have written down.
  - Enter the network key, and select <Apply>.

**8** Select <Yes>.**NOTE:****If an error message is displayed during setup**

- Select <Close>, check whether the specified settings are correct, and return to step 5.

**9** Wait until message <Connected.> is displayed.**10** Select <Close>.

⇒ Wait several minutes until the IP address and other items are set automatically.

**IMPORTANT:****Signal strength**

- When more than one wireless router is available for connection, the machine connects to the device with the strongest signal. Signal strength is measured using RSSI (Received Signal Strength Indication).

**NOTE:**

- You can set the IP address manually. ▶ **Setting IP Addresses(P. 31)**
- While the machine is connected to the wireless LAN, the Wi-Fi icon is displayed in the Home screen or the Basic Features screen of each function. ▶ **Basic Screens(P. 120)**

**NOTE****Reducing power consumption**

- You can set the machine to enter <Power Save Mode> based on signals emitted from the wireless router. ▶ **<Power Save Mode>(P. 458)**

**If the IP address of the machine has changed**

- In a DHCP environment, the IP address of the machine may be changed automatically. If this happens, the connection is maintained as long as the machine and the computer belong to the same subnet.

**LINKS**

- ▶ **Connecting to a Wireless LAN(P. 18)**

## Checking the SSID and Network Key

261J-00H

When manually setting up a wireless connection, you need to specify the SSID and network key of your wireless router. The SSID and network key may be indicated on these networking devices. Check your devices and write down the necessary information before setting up the connection. For more information, see the instruction manuals for your networking devices or contact your manufacturer.

<b>SSID</b>	A name given for identifying a specific wireless LAN. Some other terms used for SSID include "access point name" and "network name."
<b>Network Key</b>	A keyword or password used for encrypting data or authenticating a network. Some other terms used for network key include "encryption key," "WEP key," "WPA/WPA2 passphrase," and "preshared key (PSK)."
<b>Wireless Security Protocols (Authentication/Encryption)</b>	When manually setting up a wireless connection by specifying detailed settings, you need to specify security settings. Check the following information: <ul style="list-style-type: none"> <li>• Security types (WEP/WPA-PSK/WPA2-PSK)</li> <li>• Authentication method (Open System/Shared Key)</li> <li>• Encryption method (TKIP/AES-CCMP)</li> </ul>

### ■ Checking the SSID and Network Key from a Computer

The SSID or the network key may have been changed. If you do not know the SSID or the network key, you can check them by using the "Canon MF/LBP Wireless Setup Assistant." Download the "Canon MF/LBP Wireless Setup Assistant" from the Canon website (<http://www.canon.com/>), and start it up from a computer connected to a wireless LAN.

## NOTE

- If no access point is displayed on the screen after startup of the "Canon MF/LBP Wireless Setup Assistant," check if the setup is completed both on the computer and the wireless LAN router.

## LINKS

- ▶ **Connecting to a Wireless LAN(P. 18)**
- ▶ **Setting Up Connection by Selecting a Wireless Router(P. 24)**
- ▶ **Setting Up Connection by Specifying Detailed Settings(P. 27)**

## Setting IP Addresses

261J-00J

Connecting the machine to a network requires a unique network IP address. Two versions of IP addresses are available: IPv4 and IPv6. Configure these settings depending on the network environment. To use IPv6 addresses, you need to properly configure the IPv4 address settings.

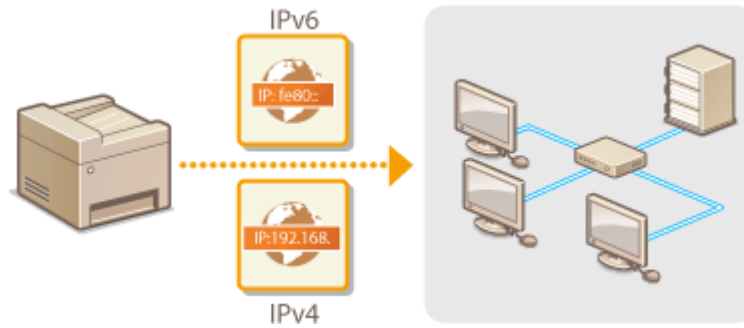

- ▶ [Setting IPv4 Address\(P. 32\)](#)
- ▶ [Setting IPv6 Addresses\(P. 35\)](#)

# Setting IPv4 Address

261J-00K



The machine's IPv4 address can be either assigned automatically by a dynamic IP addressing protocol, such as DHCP, or entered manually. When connecting the machine to a wired LAN, make sure that the connectors of the LAN cable are firmly inserted into the ports ( [▶Connecting to a Wired LAN\(P. 17\)](#) ). You can test the network connection if necessary.

- ▶[Setting IPv4 Address\(P. 32\)](#)
- ▶[Testing the Network Connection\(P. 33\)](#)

## Setting IPv4 Address

- 1** Select **<Menu>** in the Home screen. [▶Home Screen\(P. 121\)](#)
- 2** Select **<Preferences>** ▶ **<Network>**.
  - If the login screen appears, enter the correct ID and PIN. [▶Logging in to the Machine\(P. 132\)](#)
- 3** Select **<TCP/IP Settings>** ▶ **<IPv4 Settings>** ▶ **<IP Address Settings>**.
- 4** Configure IP address settings.

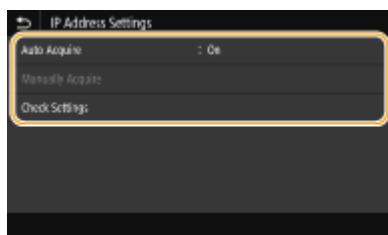

### <Auto Acquire>

Select to automatically assign an IP address via DHCP protocol. When **<On>** is displayed, automatic addressing is enabled.

### <Manually Acquire>

Select to configure the IP address settings by manually entering an IP address. In order to select this option, the automatic acquirement must be set to **<Off>**.

### <Check Settings>

Select when you want to view the current IP address settings.

## ■Automatically assigning an IP address

- 1** Select **<Auto Acquire>**.
- 2** Select **<On>** in **<Auto Acquire>**, and select **<Select Protocol>**.
- 3** Select **<DHCP>**.



**NOTE:****If you do not want to use DHCP/BOOTP/RARP to assign an IP address**

- Select <Off>. If you select <DHCP> when these services are unavailable, the machine will waste time and communications resources searching the network for these services.
- 4 Check that <Auto IP> is set to <On>.
    - If <Off> is selected, change the setting to <On>.
  - 5 Select <Apply>.

**NOTE:**

- IP addresses assigned via DHCP override the address obtained via Auto IP.

**Manually entering an IP address**

- 1 Select <Auto Acquire>, and select <Off> ► <Apply> in <Auto Acquire>.
  - 2 Select <Manually Acquire>.
  - 3 Enter <IP Address>, <Subnet Mask>, and <Gateway Address>, and select <Apply>.
- 5 Select <OK>.**

**6 Restart the machine.**

- Turn OFF the machine, wait for at least 10 seconds, and turn it back ON.

**NOTE****Checking whether the settings are correct**

- Make sure that the Remote UI screen can be displayed with your computer ( ► **Starting Remote UI(P. 415)** ). If a computer is not available, you can check the connection by using the operation panel ( ► **Testing the Network Connection(P. 33)** ).

**When you have changed the IP address after installing the printer driver**

- When the MFNP port is used, the connection is maintained as long as the machine and the computer belong to the same subnet; therefore, you do not need to add a new port. When the standard TCP/IP port is used, you need to add a new port. ► **Configuring Printer Ports(P. 44)**

\*If you do not know which port is used, see ► **Checking the Printer Port(P. 703)** .

**Testing the Network Connection**

- 1 Select <Menu> in the Home screen. ► **Home Screen(P. 121)**
- 2 Select <Preferences> ► <Network>.
  - If the login screen appears, enter the correct ID and PIN. ► **Logging in to the Machine(P. 132)**

**3** Select <TCP/IP Settings> ► <IPv4 Settings> ► <PING Command>.

**4** Enter the IPv4 address of another device on the network, and select <Apply>.

▢ If a proper connection has been established, <Received response from the host.> is displayed.

## LINKS

---

- ▶ [Setting IPv6 Addresses\(P. 35\)](#)
- ▶ [Viewing Network Settings\(P. 38\)](#)
- ▶ [Configuring WINS\(P. 62\)](#)

## Setting IPv6 Addresses

261J-00L



The IPv6 addresses of the machine can be configured via the Remote UI. Before setting IPv6 addresses, check the IPv4 address settings ( [▶Viewing IPv4 Settings\(P. 38\)](#) ). You need to set the correct IPv4 settings to use IPv6 addresses. Note that the scan function that uses the scanner driver or MF Scan Utility is not available in an IPv6 environment. The machine can use the following multiple IPv6 addresses:

Type	Description
Link-local address	An address that is only valid within a subnet or link and cannot be used to communicate with devices beyond a router. A link-local address is automatically set when the IPv6 function of the machine is enabled.
Manual address	An address that is entered manually. When using this address, specify the prefix length and default router address.
Stateless address	An address that is generated automatically using the MAC address of the machine and the network prefix that is advertised by the router. Stateless addresses are discarded when the machine is restarted (or turned ON).
Stateful address	An address obtained from a DHCP server using DHCPv6.

### NOTE

- For more information about the basic operations to be performed when setting the machine from the Remote UI, see [▶Setting Up Menu Options from Remote UI\(P. 424\)](#) .

- 1 Start the Remote UI and log in to System Manager Mode. [▶Starting Remote UI\(P. 415\)](#)**
- 2 Click [Settings/Registration] on the Portal page. [▶Remote UI Screen\(P. 416\)](#)**
- 3 Select [Network Settings] ▶ [IPv6 Settings].**
- 4 Click [Edit].**
- 5 Select the [Use IPv6] check box and configure the required settings.**

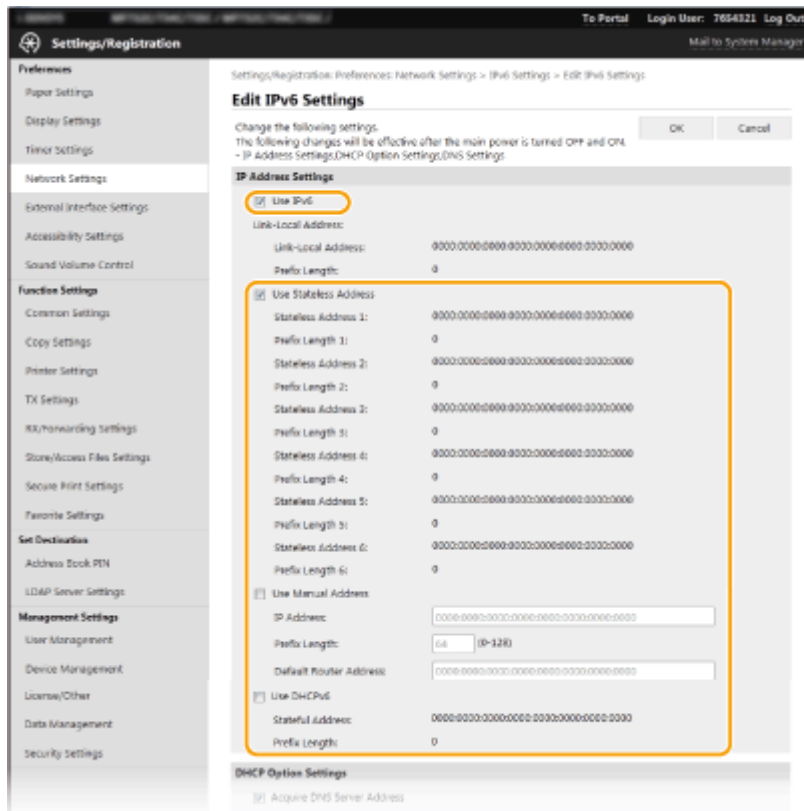
**[Use IPv6]**

Select the check box to enable IPv6 on the machine. When not using IPv6, clear the check box.

**[Stateless Address 1]**

Select the check box when using a stateless address. When not using a stateless address, clear the check box.

**[Use Manual Address]**

When you want to manually enter an IPv6 address, select the check box and enter the IP address, prefix length, and default router address in the corresponding text boxes.

**[IP Address]**

Enter an IPv6 address. Addresses that start with "ff" (or multicast address) cannot be entered.

**[Prefix Length]**

Enter a number that indicates how many bits are available for the network address.

**[Default Router Address]**

Specify the IPv6 address of the default router as necessary. Addresses that start with "ff" (or multicast address) cannot be entered.

**[Use DHCPv6]**

Select the check box when using a stateful address. When not using DHCPv6, clear the check box.

**6 Click [OK].****7 Restart the machine.**

- Turn OFF the machine, wait for at least 10 seconds, and turn it back ON.

**NOTE****Checking whether the settings are correct**

- Make sure that the Remote UI screen can be displayed with your computer by using the IPv6 address of the machine. [Starting Remote UI\(P. 415\)](#)

### Selecting settings from the operation panel

- IPv6 settings can also be accessed from <Menu> in the Home screen. [▶<IPv6 Settings>\(P. 461\)](#)

### When you have changed the IP address after installing the printer driver

- You need to add a new port. [▶Configuring Printer Ports\(P. 44\)](#)

### LINKS

---

[▶Setting IPv4 Address\(P. 32\)](#)

[▶Viewing Network Settings\(P. 38\)](#)

# Viewing Network Settings

261J-00R

- ▶ Viewing IPv4 Settings(P. 38)
- ▶ Viewing IPv6 Settings(P. 38)
- ▶ Viewing the MAC Address for Wired LAN(P. 38)
- ▶ Viewing the MAC Address and Information for Wireless LAN(P. 39)

## NOTE

- The IP address is not correctly configured if it is displayed as "0.0.0.0".
- Connecting the machine to a switching hub or bridge may result in a connection failure even when the IP address is correctly configured. This problem can be solved by setting a certain interval before the machine starts communicating. ▶ **Setting a Wait Time for Connecting to a Network(P. 55)**
- You can print a list of the current network settings. ▶ **User Data List/System Manager Data List(P. 583)**

## Viewing IPv4 Settings



<Status Monitor> ▶ <Network Information> ▶ <IPv4> ▶ Select the setting to view ▶ Check the settings

## Viewing IPv6 Settings



<Status Monitor> ▶ <Network Information> ▶ <IPv6> ▶ Select the setting to view ▶ Check the settings

## Viewing the MAC Address for Wired LAN

- 1** Select <Menu> in the Home screen. ▶ **Home Screen(P. 121)**
- 2** Select <Preferences> ▶ <Network>.
  - If the login screen appears, enter the correct ID and PIN. ▶ **Logging in to the Machine(P. 132)**
- 3** Select <Ethernet Driver Settings>.
  - ▣ The MAC address is displayed.

## Viewing the MAC Address and Information for Wireless LAN

- 1 Select <Menu> in the Home screen. [▶Home Screen\(P. 121\)](#)
- 2 Select <Preferences> ▶ <Network>.
  - If the login screen appears, enter the correct ID and PIN. [▶Logging in to the Machine\(P. 132\)](#)
- 3 Select <Wireless LAN Settings>.
- 4 Read the message that is displayed, and select <OK>.
- 5 Select <Connection Information>.
- 6 Select the setting to view.

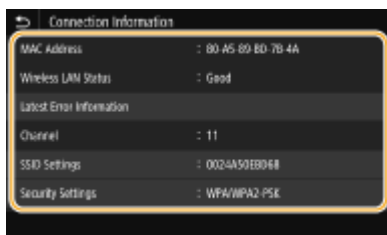

### NOTE:

#### Viewing security information

- To view WEP and WPA/WPA2-PSK information, select <Security Settings>.

#### Viewing from the <Status Monitor> screen

- <Wireless LAN Status> and <Latest Error Information> can be viewed from <Status Monitor>.  
 <Status Monitor> ▶ <Network Information> ▶ <Network Connection Type> ▶ Select the setting to view

### LINKS

- [▶Connecting to a Wireless LAN\(P. 18\)](#)
- [▶Setting IPv4 Address\(P. 32\)](#)
- [▶Setting IPv6 Addresses\(P. 35\)](#)
- [▶Configuring DNS\(P. 56\)](#)

# Configuring Settings for Communication with a Computer

261J-00S

Specify the protocol and port when operating the machine from a computer via the network. Before configuring the machine for printing or faxing from a computer, perform the basic setup procedures. For more information, see the manuals for the relevant drivers on the online manual website.

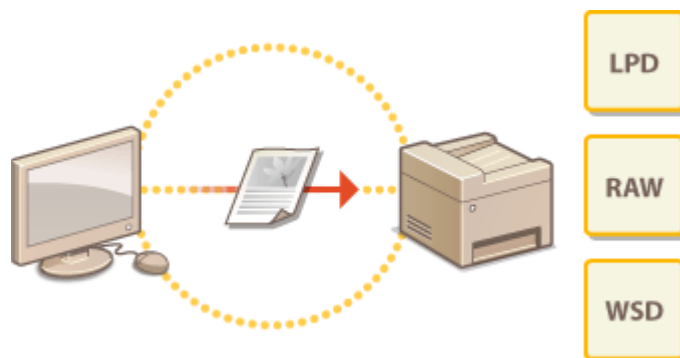

- ▶ [Configuring Printing Protocols and WSD Functions\(P. 41\)](#)
- ▶ [Configuring Printer Ports\(P. 44\)](#)
- ▶ [Setting Up Print Server\(P. 48\)](#)

## NOTE

- Protocols explained here are rules for delivering document data between a computer and the machine, and can be selected according to intended purposes or the network environment.
- Ports are gateways for passing data between network devices. If a communication failure occurs in the network connection, the port settings may be the cause of the problem.



# Configuring Printing Protocols and WSD Functions

261J-00U

Configure the protocols that are used for printing documents from a networked computer.

## NOTE

- For more information about the basic operations to be performed when setting the machine from the Remote UI, see [▶Setting Up Menu Options from Remote UI\(P. 424\)](#) .

- 1 Start the Remote UI and log in to System Manager Mode.** [▶Starting Remote UI\(P. 415\)](#)
- 2 Click [Settings/Registration] on the Portal page.** [▶Remote UI Screen\(P. 416\)](#)
- 3 Click [Network Settings].**
- 4 Configure printing protocols.**

### ■Configuring LPD or RAW

- Select [LPD Settings] or [RAW Settings] ▶ [Edit].
- Configure the settings as necessary.

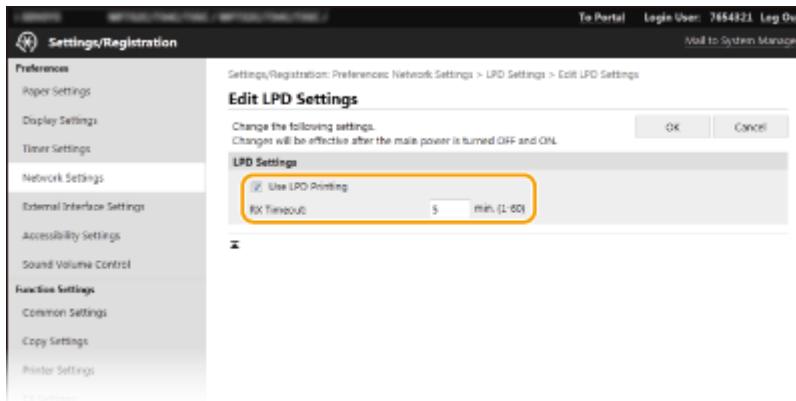

#### [Use LPD Printing]

Select the check box to print via LPD. When not using LPD printing, clear the check box.

#### [Use RAW Printing]

Select the check box to print via RAW. When not using RAW printing, clear the check box.

#### [RX Timeout]

Set a value as the restart wait time for data reception. If data reception does not resume within the set time, printing is canceled.

- 3 Click [OK].**

## ■ Configuring WSD

- 1 Select [WSD Settings] ► [Edit].
- 2 Configure the settings as necessary.

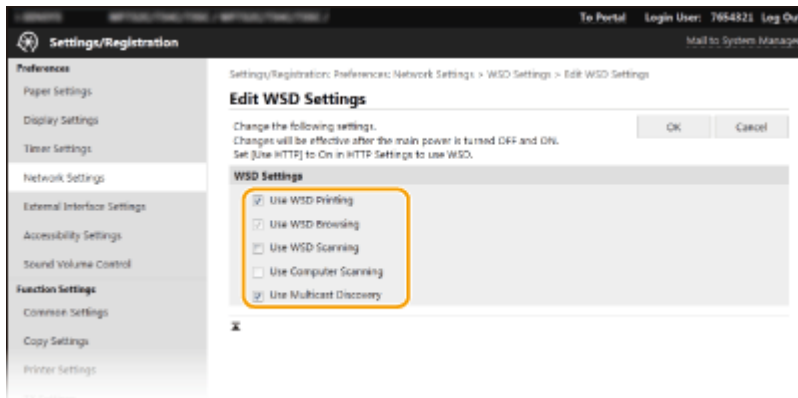

### [Use WSD Printing]

Select the check box to print via WSD. When not using WSD printing, clear the check box.

### [Use WSD Browsing]

Select the check box to obtain information about the machine from a computer via WSD. This check box is automatically selected when the [Use WSD Printing] check box is selected.

### [Use WSD Scanning]

WSD scanning enables you to scan documents to a computer without installing the scanner driver. Select the check box to scan documents via WSD. When not using WSD scanning, clear the check box.

### [Use Computer Scanning]

Select the check box to use WSD scanning by operating the machine with the operation panel. This check box can only be selected when the [Use WSD Scanning] check box is selected. To perform scanning, select <Scan> in the Home screen and specify a WSD-connected computer as a scan destination ( ► **Scanning and Saving to a Computer(P. 280)** ).

### [Use Multicast Discovery]

Select the check box to set the machine to reply to multicast discovery messages. If the check box is cleared, the machine stays in sleep mode even when multicast discovery messages are flowing on the network.

- 3 Click [OK].

## 5 Restart the machine.

- Turn OFF the machine, wait for at least 10 seconds, and turn it back ON.

## NOTE

### Selecting settings from the operation panel

- LPD, RAW, and WSD settings can also be accessed from <Menu> in the Home screen.
  - <LPD Settings>(P. 463)
  - <RAW Settings>(P. 464)
  - <WSD Settings>(P. 464)

### Setting up WSD network devices

- The WSD network devices can be added from the printer folder. Open the printer folder ( ► **Displaying the Printer Folder(P. 698)** ) ► click [Add a device] or [Add a printer] and follow the on-screen instructions. For

more information about how to install the driver for the WSD network, see the manuals for the relevant drivers on the online manual website.

### To change the port number

- The same port number used for the machine and a computer must be used for printing protocol.
  - ▶ **Configuring Printer Ports(P. 44)**
  - ▶ **Changing Port Numbers(P. 372)**

## LINKS

---

- ▶ **Configuring Printer Ports(P. 44)**

# Configuring Printer Ports

261J-00W

Printing errors can occur when the IP address of the machine has been changed, or when a printer has been added via the Windows printer folder. These errors are typically caused by incorrect printer port settings. For example, an incorrect port number or port type may have been specified. In such situations, your attempt to print fails because the document data cannot reach the machine. To fix this type of problem, configure the printer port settings on the computer.

## IMPORTANT

- To perform the following procedure, log in to your computer with an administrator account.

- 1 Open the printer folder. ▶ **Displaying the Printer Folder(P. 698)**
- 2 Right-click the driver icon for this machine, and click [Printer properties] or [Properties].
- 3 Click the [Ports] tab and configure the required settings.

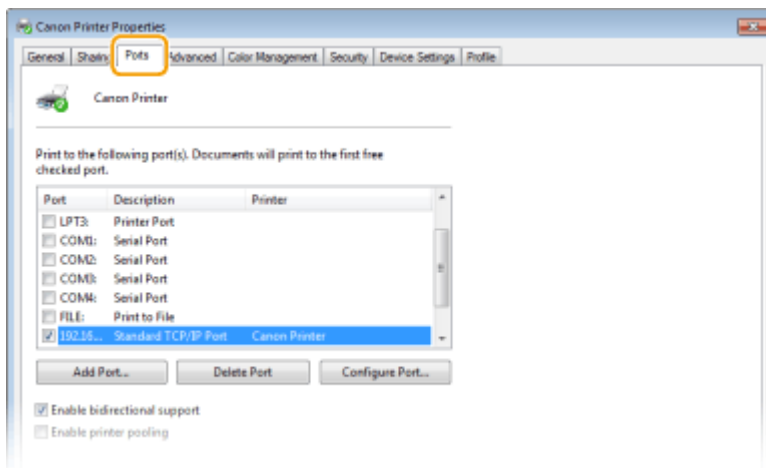

### ■ Adding a port

If you have changed the IP address of the machine or you have selected an incorrect port while installing drivers from the Windows printer folder, add a new port. There are two types of port: "MFNP Port" and "Standard TCP/IP Port." Select the port type according to your environment.

<p>MFNP Port (only for IPv4 environment)</p>	<p>This is a port that allows the IP address of the machine to be detected automatically. Even if the IP address of the machine is changed, the connection is maintained, provided that the machine and the computer are in the same subnet. You do not need to add a new port every time the IP address is changed. If you are using the machine in an IPv4 environment, you should normally select this type of port.</p> <p><b>IMPORTANT:</b></p> <ul style="list-style-type: none"> <li>You can add an MFNP port only when you installed the driver from the provided CD-ROM/DVD-ROM, or when you downloaded and installed the printer driver or the fax driver from the Canon website.</li> </ul>
--	--

Standard TCP/IP Port	This is a standard Windows port. When you use this type of port, you need to add a new port every time that the IP address of the machine is changed. Select this type of port when you are using the machine in an IPv6 environment and when you cannot add an MFNP port.
----------------------	--

### Adding an MFNP port

- 1 Click [Add Port].
- 2 Select [Canon MFNP Port] in [Available port types] and click [New Port].
- 3 Select [Auto Detect] and select the machine when it is detected, and then click [Next].

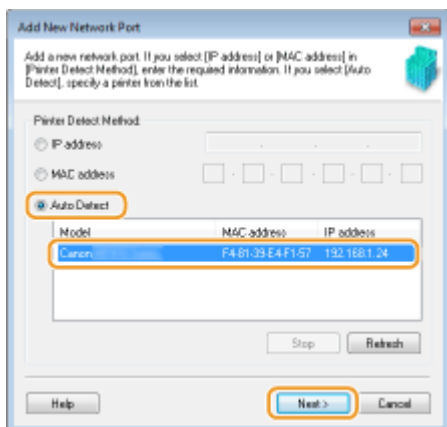

### NOTE:

#### If the machine is not detected

- Click [Refresh]. If the problem persists, select [IP address] or [MAC address], enter the IP address or MAC address of the machine ( [Viewing Network Settings\(P. 38\)](#) ) and then click [Next].

- 4 Click [Add] ► [Finish].
- 5 Click [Close].

### Adding a standard TCP/IP port

- 1 Click [Add Port].
- 2 Select [Standard TCP/IP Port] in [Available port types] and click [New Port].
- 3 Click [Next].
- 4 Enter the IP address or the DNS name of the machine, and click [Next].
  - The [Port Name] is entered automatically. If necessary, you can change it.

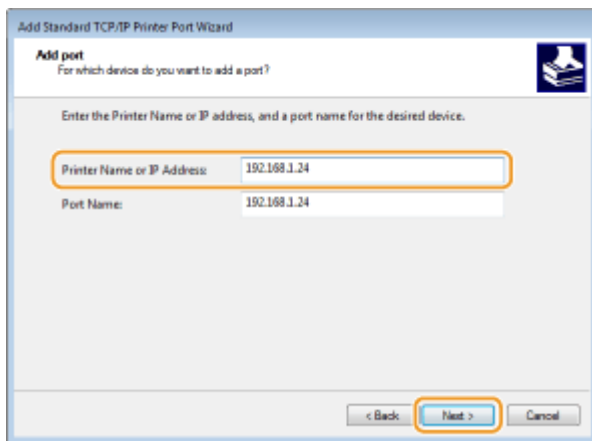

**NOTE:**

- When the next screen is displayed, follow the instructions on the screen.

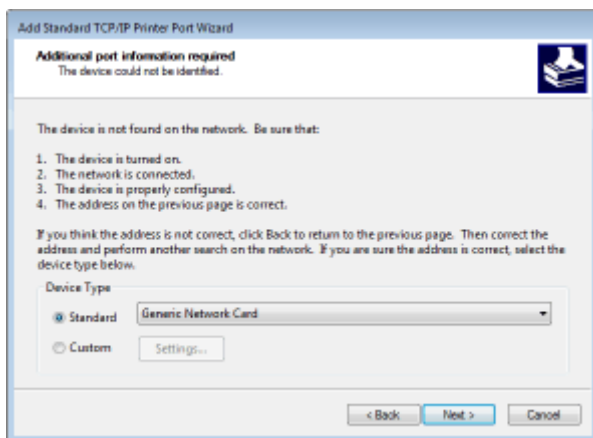

\*When you select the [Device Type], select [Canon Network Printing Device with P9100] under [Standard].

- 5 Click [Finish].
- 6 Click [Close].

**■ Changing the port type or number**

If the printing protocol (LPD or RAW) has been changed on the machine side ( **▶Configuring Printing Protocols and WSD Functions(P. 41)** ) or the port number has been changed ( **▶Changing Port Numbers(P. 372)** ), the corresponding settings on the computer must also be configured. This operation is not needed for WSD ports.

**MFNP port**

- 1 Click [Configure Port].
- 2 Under [Protocol Type], select [RAW] or [LPR], and change the [Port Number].
- 3 Click [OK].

**Standard TCP/IP port**

- 1 Click [Configure Port].
- 2 Under [Protocol], select [Raw] or [LPR].

- If you selected [Raw], change the [Port Number].
- If you selected [LPR], enter "lp" in [Queue Name].

**3** Click [OK].

**4** Click [Close].

## LINKS

---

🔗 [Setting Up Print Server\(P. 48\)](#)

# Setting Up Print Server

261J-00X

With a print server, you can reduce the load on the computer that you print from. The print server also makes it possible to install the drivers on each computer over the network, which saves you the trouble of installing the drivers on each computer by using the provided CD-ROM/DVD-ROM. To set up a computer on the network as a print server, configure the settings for sharing the printer.

## IMPORTANT

- To perform the following procedure, log in to your computer with an administrator account.
- You may be unable to install drivers over the network depending on the operating system and the bit architecture (32-bit or 64-bit) of the print server and client computers.
- When implementing a print server in a domain environment, consult your Network Administrator.

## NOTE

### To carry out Department ID Management when using a print server

- "Canon Driver Information Assist Service" must be added during the printer driver installation. For more information, see the manuals for the relevant drivers on the online manual website.

- 1 Open the printer folder. ▶Displaying the Printer Folder(P. 698)**
- 2 Right-click the printer driver icon for this machine and click [Printer properties] or [Properties].**
- 3 Click the [Sharing] tab, select [Share this printer], and enter the share name of the machine.**

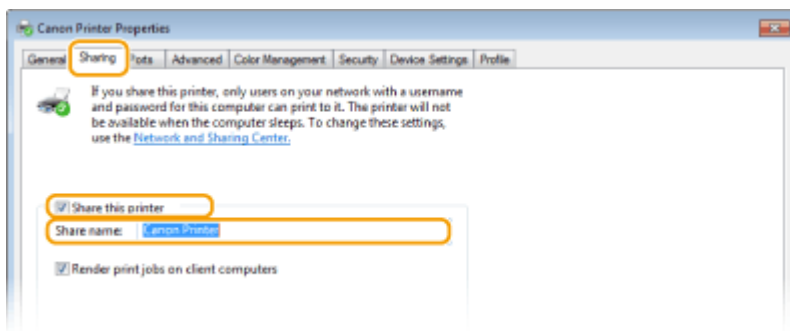

### NOTE:

- Click the [Change Sharing Options] button if displayed.

### 4 Install additional drivers as necessary.

- This operation is required if you want to install the drivers in other computers running a different bit architecture via the print server.



- 1 Click [Additional Drivers].
- 2 Select the check box for the bit architecture that other computers are running, and click [OK].

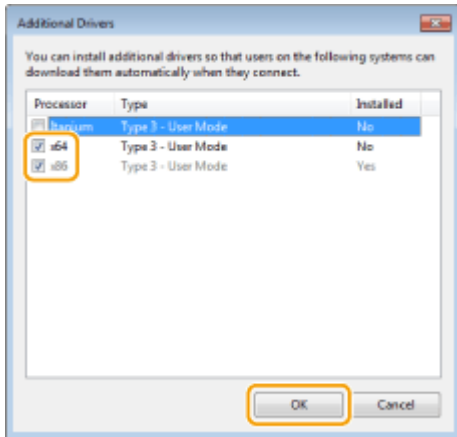

- Select additional drivers from the following, according to the operating system of the print server.

Print server	Select the check box for
32-bit operating systems	[x64]
64-bit operating systems	[x86] under [Processor]

**NOTE:**

- If you do not know whether your Windows operating system is a 32-bit or 64-bit version, see [▶ Checking the Bit Architecture\(P. 701\)](#) .
- 3 Insert the provided CD-ROM/DVD-ROM into the drive on the computer, click [Browse] to specify the folder that contains the drivers, and then click [OK].
    - If the print server runs a 32-bit operating system, select [intdrv] ▶ [UFRII] ▶ [uk\_eng] ▶ [x64] ▶ [Driver] folders on the provided CD-ROM/DVD-ROM.
    - If the print server runs a 64-bit operating system, select [intdrv] ▶ [UFRII] ▶ [uk\_eng] ▶ [32BIT] ▶ [Driver] folders on the provided CD-ROM/DVD-ROM.
  - 4 Follow the on-screen instructions to install additional drivers.

**5 Click [OK].**

**■ Installing the Drivers on a Computer via the Print Server**

- 1 **Locate the shared printer in the print server. ▶ Displaying Shared Printers in the Print Server(P. 699)**
- 2 **Double-click the shared printer.**

### **3** Follow the on-screen instructions to install the drivers.

#### LINKS

---

▶ **Printing from a Computer(P. 254)**

## Configuring the Machine for Your Network Environment

261J-00Y

The configuration of a network varies depending on the purpose of the network. The machine has been designed to be compatible with as many network configurations as possible, and it is equipped with a variety of technologies. Consult your Network Administrator and set a configuration to suit your network environment.

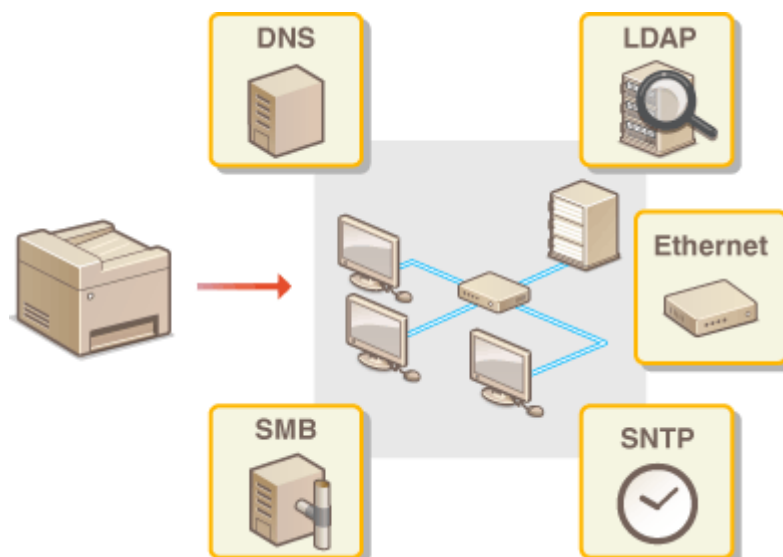

- ▶ **Configuring Ethernet Settings(P. 52)**
- ▶ **Changing the Maximum Transmission Unit(P. 54)**
- ▶ **Setting a Wait Time for Connecting to a Network(P. 55)**
- ▶ **Configuring DNS(P. 56)**
- ▶ **Configuring SMB(P. 60)**
- ▶ **Configuring WINS(P. 62)**
- ▶ **Registering LDAP Servers(P. 64)**
- ▶ **Monitoring and Controlling the Machine with SNMP(P. 69)**
- ▶ **Other Network Settings(P. 73)**

# Configuring Ethernet Settings

261J-010

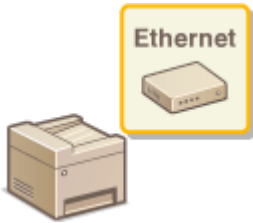

Ethernet is a standard for communicating data in a local area network (LAN). You can set the communication mode and the Ethernet type. In general, the machine can be used without changing the defaults ( ▶<Ethernet Driver Settings>(P. 468) ), but you can change these settings to suit your network environment.

**1** Select <Menu> in the Home screen. ▶<Home Screen>(P. 121)

**2** Select <Preferences> ▶ <Network>.

- If the login screen appears, enter the correct ID and PIN. ▶<Logging in to the Machine>(P. 132)

**3** Select <Ethernet Driver Settings>.

**4** Select whether to configure Ethernet settings automatically or manually.

- If auto-detection is enabled, the machine detects and automatically sets the Ethernet communication mode and the type that can be used.

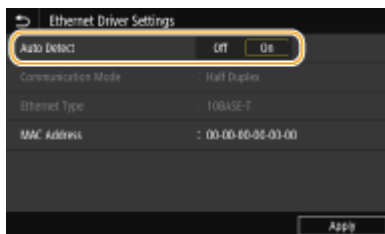

## ■ Configuring Ethernet settings automatically

Select <On> in <Auto Detect>.

## ■ Configuring Ethernet settings manually

**1** Select <Off> in <Auto Detect>.

**2** <Communication Mode> ▶ select the communication mode.



### <Half Duplex>

Alternately sends and receives communication data. Select when the machine is connected to a networking device using half duplex.

**<Full Duplex>**

Simultaneously sends and receives communication data. Use this setting for most environments.

**3** <Ethernet Type> ► select the Ethernet type.

**4** Select <Apply>.

**5** Select <OK>.

**6** Restart the machine.

- Turn OFF the machine, wait for at least 10 seconds, and turn it back ON.

LINKS

---

► **Changing the Maximum Transmission Unit(P. 54)**

► **Setting a Wait Time for Connecting to a Network(P. 55)**

# Changing the Maximum Transmission Unit

---

261J-011

In most Ethernet networks, the maximum size of a packet that can be sent is 1500 bytes. A packet refers to a chunk of data into which the original data is divided before being sent. The maximum transmission unit (MTU) may vary on each network. Change the settings of the machine as necessary. For more information, contact your Network Administrator.

**1** Select **<Menu>** in the Home screen. **▶Home Screen(P. 121)**

**2** Select **<Preferences>** ▶ **<Network>**.

- If the login screen appears, enter the correct ID and PIN. **▶Logging in to the Machine(P. 132)**

**3** Select **<TCP/IP Settings>** ▶ **<MTU Size>**.

**4** Select the MTU.

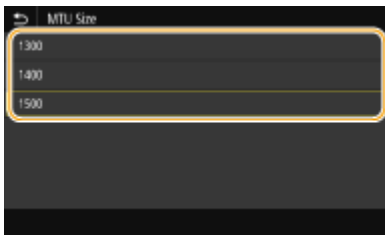

**5** Select **<OK>**.

**6** Restart the machine.

- Turn OFF the machine, wait for at least 10 seconds, and turn it back ON.

## LINKS

---

**▶Configuring Ethernet Settings(P. 52)**

**▶Setting a Wait Time for Connecting to a Network(P. 55)**

# Setting a Wait Time for Connecting to a Network

---

261J-012

When a network is designed to enjoy redundant connectivity with multiple switching hubs or bridges, it must have a mechanism to prevent packets from looping. One effective solution is to define the role of each switch port. However, communication may still be disrupted for several tens of seconds immediately after you change the way that network devices are connected, or if you add a new device. If this type of problem occurs, set a wait time for connecting to the network.

- 1** Select **<Menu>** in the Home screen. [▶Home Screen\(P. 121\)](#)
  
- 2** Select **<Preferences>** ▶ **<Network>**.
  - If the login screen appears, enter the correct ID and PIN. [▶Logging in to the Machine\(P. 132\)](#)
  
- 3** Select **<Wait Time for Conn. at Startup>**.
  
- 4** Enter the waiting time required to start a communication with the network, and select **<Apply>**.

## LINKS

---

- [▶Configuring Ethernet Settings\(P. 52\)](#)
- [▶Changing the Maximum Transmission Unit\(P. 54\)](#)

## Configuring DNS

261J-013

DNS (Domain Name System) provides a service for name resolution that associates a host (or domain) name with an IP address. Configure the DNS, mDNS, or DHCP option settings as necessary. Note that the procedures for configuring DNS are different for IPv4 and IPv6.



### NOTE

- For more information about the basic operations to be performed when setting the machine from the Remote UI, see [▶Setting Up Menu Options from Remote UI\(P. 424\)](#) .

- 1 Start the Remote UI and log in to System Manager Mode. ▶Starting Remote UI(P. 415)**
- 2 Click [Settings/Registration] on the Portal page. ▶Remote UI Screen(P. 416)**
- 3 Click [Network Settings].**
- 4 Configure DNS settings.**

#### ■Configuring IPv4 DNS

- 1** Select [IPv4 Settings] ▶ [Edit].
- 2** Configure IPv4 DNS settings.





### **a** [DHCP Option Settings]

#### **[Acquire Host Name]**

Select the check box to enable Option 12 to obtain the host name from the DHCP server.

#### **[DNS Dynamic Update]**

Select the check box to enable Option 81 to dynamically update the DNS records through the DHCP server.

#### **[Acquire DNS Server Address]**

Select the check box to enable Option 6 to obtain a DNS server address from the DHCP server.

#### **[Acquire Domain Name]**

Select the check box to enable Option 15 to obtain a domain name from the DHCP server.

#### **[Acquire WINS Server Address]**

Select the check box to enable Option 44 to obtain a WINS server address from the DHCP server.

#### **[Acquire SMTP Server Address]**

Select the check box to enable Option 69 to obtain an SMTP server address from the DHCP server.

#### **[Acquire POP Server Address]**

Select the check box to enable Option 70 to obtain a POP3 server address from the DHCP server.

### **b** [DNS Settings]

#### **[Primary DNS Server Address]**

Enter the IP address of a DNS server.

#### **[Secondary DNS Server Address]**

Enter the IP address of a secondary DNS server, if any.

#### **[Host Name]**

Enter alphanumeric characters for the host name of the machine that is to be registered to the DNS server.

#### **[Domain Name]**

Enter alphanumeric characters for the name of the domain the machine belongs to, such as "example.com."

#### **[DNS Dynamic Update]**

Select the check box to dynamically update the DNS records whenever the machine's IP address is changed. When specifying the interval between updates, enter the time in hours in the [DNS Dynamic Update Interval] text box.

**c [mDNS Settings]**

**[Use mDNS]**

Adopted by Bonjour, mDNS (multicast DNS) is a protocol for associating a host name with an IP address without using DNS. Select the check box to enable mDNS and enter the mDNS name in the [mDNS Name] text box.

**3** Click [OK].

**■ Configuring IPv6 DNS**

**1** Select [IPv6 Settings] ► [Edit].

**2** Configure IPv6 DNS settings.

- The [Use IPv6] check box must be selected to configure the settings. ► **Setting IPv6 Addresses(P. 35)**

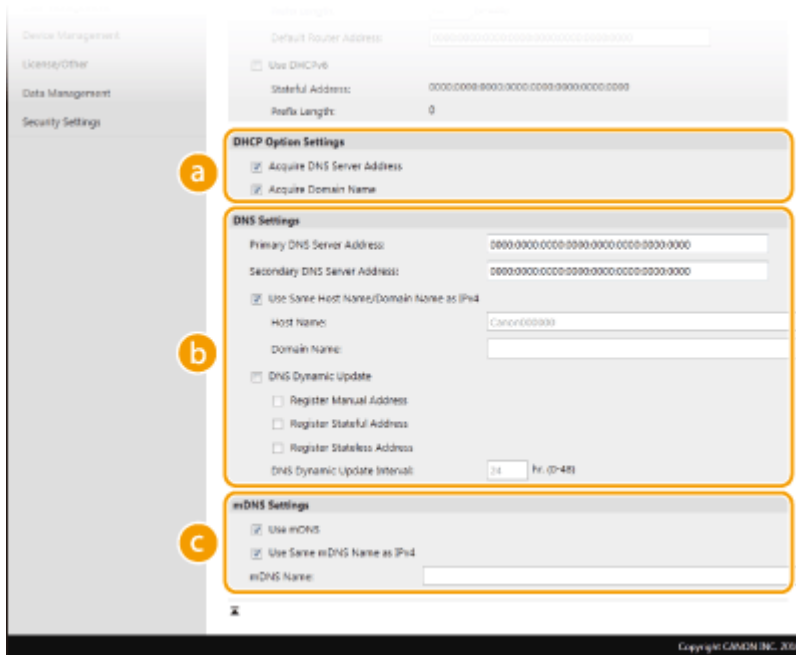

**a [DHCP Option Settings]**

**[Acquire DNS Server Address]**

Select the check box to enable Option 23 to obtain a DNS server address from the DHCP server.

**[Acquire Domain Name]**

Select the check box to enable Option 24 to obtain a domain name from the DHCP server.

**b [DNS Settings]**

**[Primary DNS Server Address]**

Enter the IP address of a DNS server. Addresses that start with "ff" (or multicast address) cannot be entered.

**[Secondary DNS Server Address]**

Enter the IP address of a secondary DNS server, if any. Addresses that start with "ff" (or multicast address) cannot be entered.

**[Use Same Host Name/Domain Name as IPv4]**

Select the check box to use the same host and domain names as in IPv4.

**[Host Name]**

Enter alphanumeric characters for the host name of the machine that is to be registered to the DNS server.

**[Domain Name]**

Enter alphanumeric characters for the name of the domain the machine belongs to, such as "example.com."

**[DNS Dynamic Update]**

Select the check box to dynamically update the DNS records whenever the machine's IP address is changed. To specify the type(s) of addresses you want to register to the DNS server, select the check box for [Register Manual Address], [Register Stateful Address], or [Register Stateless Address]. To specify the interval between updates, enter the time in hours in the [DNS Dynamic Update Interval] text box.

** [mDNS Settings]****[Use mDNS]**

Adopted by Bonjour, mDNS (multicast DNS) is a protocol for associating a host name with an IP address without using DNS. Select the check box to enable mDNS.

**[Use Same mDNS Name as IPv4]**

Select the check box to use the same mDNS name as in IPv4. To set a different name, clear the check box and enter the mDNS name in the [mDNS Name] text box.

**3** Click [OK].

**5 Restart the machine.**

- Turn OFF the machine, wait for at least 10 seconds, and turn it back ON.



## NOTE

### Selecting settings from the operation panel

- DNS settings can also be accessed from <Menu> in the Home screen.  <DNS Settings>(P. 462)

## LINKS

---

-  [Setting IPv4 Address\(P. 32\)](#)
-  [Setting IPv6 Addresses\(P. 35\)](#)
-  [Viewing Network Settings\(P. 38\)](#)

# Configuring SMB

261J-014



Server Message Block (SMB) is a protocol for sharing resources, such as files and printers, with more than one device in a network. The machine uses SMB to store scanned documents into a shared folder. Depending on your network, you may have to set the NetBIOS name and workgroup name.

## NetBIOS Name

In a Windows network that uses NetBIOS, NetBIOS names are used for identifying network-connected computers as well as for file sharing and other network services. Most computers use the computer name as the NetBIOS name.

## Workgroup Name

Workgroup name is a name for grouping multiple computers so that basic network functions, such as file sharing, become available in a Windows network. Specify the workgroup name to identify the group that the machine belongs to.

## NOTE

- For more information about the basic operations to be performed when setting the machine from the Remote UI, see [▶Setting Up Menu Options from Remote UI\(P. 424\)](#) .

- 1 Start the Remote UI and log in to System Manager Mode. ▶Starting Remote UI(P. 415)**
- 2 Click [Settings/Registration] on the Portal page. ▶Remote UI Screen(P. 416)**
- 3 Select [Network Settings] ▶ [SMB Settings].**
- 4 Click [Edit].**
- 5 Specify the required settings.**

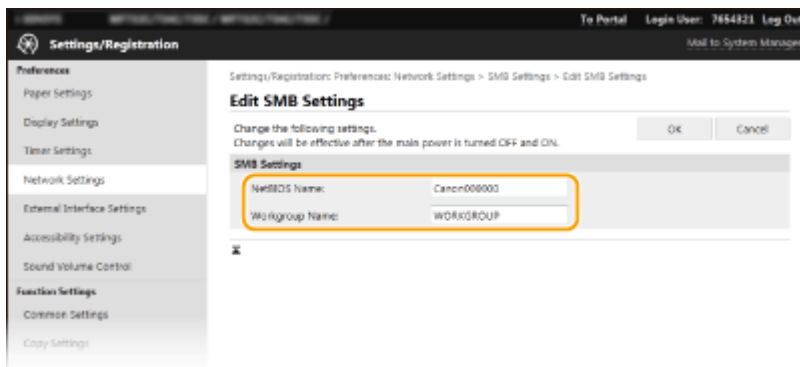

**[NetBIOS Name]**

Enter alphanumeric characters for the NetBIOS name of the machine.

**[Workgroup Name]**

Enter alphanumeric characters for the name of the workgroup that the machine belongs to.

**IMPORTANT:**

- NetBIOS names or workgroup names that start with an asterisk (\*) cannot be registered to a WINS server.

**6 Click [OK].**

**7 Restart the machine.**

- Turn OFF the machine, wait for at least 10 seconds, and turn it back ON.

LINKS

---

▶ **Configuring WINS(P. 62)**

# Configuring WINS

261J-015

Windows Internet Name Service (WINS) is a name resolution service that associates a NetBIOS name (a computer or printer name in an SMB network) with an IP address. To enable WINS, the WINS server must be specified.

## IMPORTANT

- In order to specify WINS server settings, NetBIOS name and workgroup name are required to be set. ▶ **Configuring SMB(P. 60)**
- The function is not available in an IPv6 network.

## NOTE

- For more information about the basic operations to be performed when setting the machine from the Remote UI, see ▶ **Setting Up Menu Options from Remote UI(P. 424)** .

- 1 Start the Remote UI and log in to System Manager Mode. ▶ Starting Remote UI(P. 415)**
- 2 Click [Settings/Registration] on the Portal page. ▶ Remote UI Screen(P. 416)**
- 3 Select [Network Settings] ▶ [WINS Settings].**
- 4 Click [Edit].**
- 5 Select the [WINS Resolution] check box, and specify the required settings.**

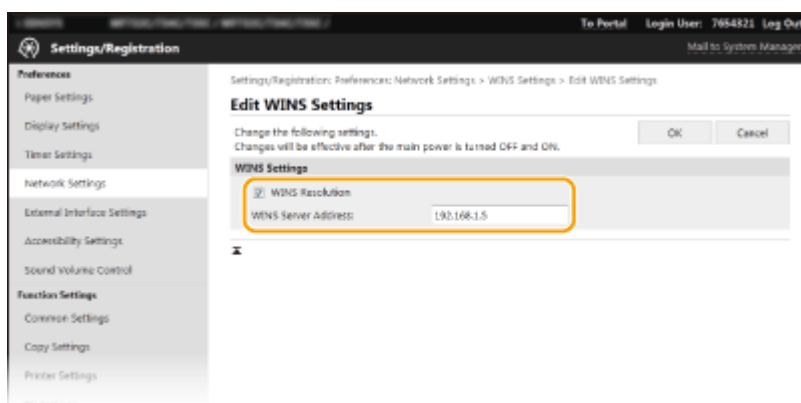

### [WINS Resolution]

Select the check box to use WINS for name resolution. When not using WINS, clear the check box.

### [WINS Server Address]

Enter the IP address of the WINS server.

## IMPORTANT:

- If the IP address of the WINS server is obtained from a DHCP server, the obtained IP address overrides the IP address entered in the [WINS Server Address] text box.

## 6 Click [OK].

## 7 Restart the machine.

- Turn OFF the machine, wait for at least 10 seconds, and turn it back ON.

## NOTE

### Selecting settings from the operation panel

- WINS settings can also be accessed from <Menu> in the Home screen. [▶<WINS Settings>\(P. 463\)](#)

## LINKS

---

- ▶ [Setting IPv4 Address\(P. 32\)](#)

## Registering LDAP Servers

261J-016



If an LDAP server is implemented in the network, you can search the server for fax numbers or e-mail addresses, and then specify them as destinations or register them in the Address Book. Note also that if send function authentication ( ▶ **LDAP Server Authentication(P. 359)** ) is enabled, you must register the server used for authentication. You can register a maximum of five LDAP servers each for searching and for authentication to the machine. Register LDAP servers via the Remote UI.

### NOTE

- For more information about the basic operations to be performed when setting the machine from the Remote UI, see ▶ **Setting Up Menu Options from Remote UI(P. 424)** .

**1 Start the Remote UI and log in to System Manager Mode. ▶ Starting Remote UI(P. 415)**

**2 Click [Settings/Registration] on the Portal page. ▶ Remote UI Screen(P. 416)**

**3 Click [LDAP Server Settings].**

**4 Click [Register New Server] for [LDAP Server (For Search)] or [LDAP Server (For Authentication)].**

- LDAP server registration needs to be performed separately either for searching or for authentication. To use an LDAP server for searching for fax and e-mail destinations, register it for searching, and to use it for authenticating sending of e-mail or faxes, register it for authenticating.

### NOTE:

#### To edit registered server information

- Click a text link under [Server Name] for the edit screen.

#### To delete registered server information

- Click [Delete] on the right of the server name you want to delete ▶ click [OK].

**5 Register the LDAP server.**

#### ■ Register the server used for searches

Register the server for searching for fax or e-mail destinations.

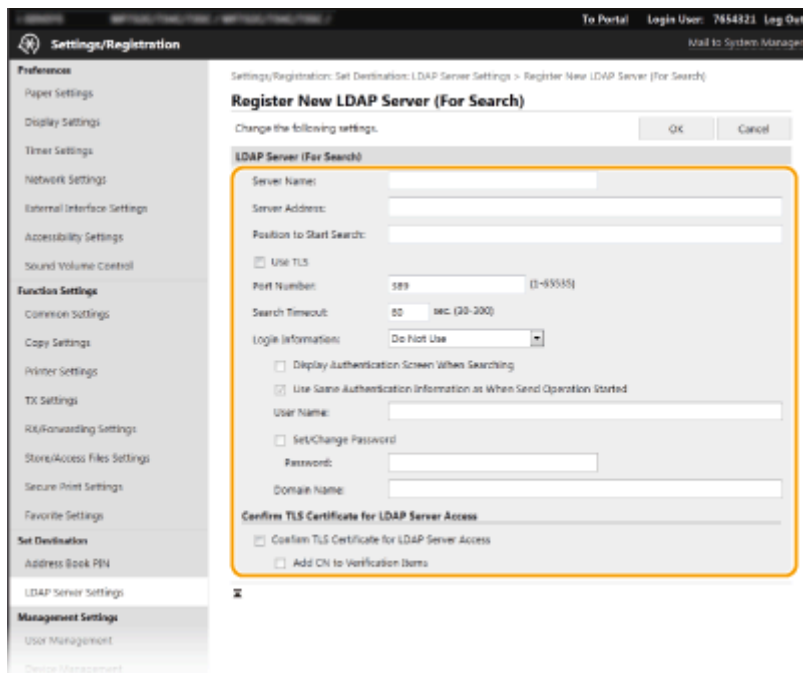

**[Server Name]**

Enter the name to be assigned to the LDAP server.

**[Server Address]**

Enter the IP address of the LDAP server or enter alphanumeric characters for the host name of the server (example: ldap.example.com).

**IMPORTANT:****[Server Address] and DNS**

- To prevent errors from occurring when searching for destinations, make sure to check the following:
  - If the host name is entered for [Server Address], make sure that a DNS server is available in the network.
  - If the IP address is entered for [Server Address], check whether the DNS server supports only forward lookup. If the server supports only forward lookup, select [Do Not Use] or [Use] for [Login Information]. If you select [Use (Security Authentication)], make sure that the DNS server supports reverse lookup.

**[Position to Start Search]**

Specify the node in the directory information tree (DIT) that you want to start search from. Leaving the text box blank sets the machine to start search from an arbitrary node selected automatically.

- When specifying the node, enter "DC=," followed by a host name (a dot-delimited character string in the Active Directory domain name), and separate each of the entries with a comma. If the domain name is "john.example.com," for example, enter "DC=john,DC=example,DC=com."

**[Use TLS]**

Select the check box to encrypt communication with the LDAP server using TLS.

**NOTE:**

- This is enabled only when [Use] or [Use (Security Authentication)] is selected in [Login Information].

**[Port Number]**

Enter the port number used for communicating with the LDAP server.

**[Search Timeout]**

Specify how long the machine searches.

**[Login Information]**

Select [Do Not Use], [Use], or [Use (Security Authentication)] depending on the type of authentication implemented by the LDAP server. When [Use] or [Use (Security Authentication)] is selected, the user name and password must be specified.

[Do Not Use]	Select not to authenticate the machine using the login information.
[Use]	Select to authenticate the machine using the login information.
[Use (Security Authentication)]	Select to use data obtained by Kerberos, a network authentication protocol, for the authentication password. If this setting is selected, the clock of the machine needs to be synchronized with that of the LDAP server.

**[Display Authentication Screen When Searching]**

Select the check box to require the user to enter the user name and password when a search is requested. If the [Use Same Authentication Information as When Send Operation Started] check box is selected, the user name and password used for authentication when sending faxes or scans are also used here. If the check box is cleared, authentication is carried out using the information entered in [User Name] and [Password].

**[Use Same Authentication Information as When Send Operation Started]**

Set whether the authentication information when the fax or scan function was used is also used when searching. This check box is normally displayed selected; however, it is only valid when the [Display Authentication Screen When Searching] check box is selected.

**[User Name]**

Enter the user name of the machine that was registered to the LDAP server.

- When [Use] is selected for [Login Information], enter the user name in the form "(domain name)\(user name)" (example: domain1\user1).
- When [Use (Security Authentication)] is selected, enter the user name only (example: user1).

**[Set/Change Password]**

To specify or change the password, select the check box and enter alphanumeric characters in the [Password] text box.

**[Domain Name]**

When [Use (Security Authentication)] is selected for [Login Information], enter alphanumeric characters for the directory tree name in Active Directory (example: example.com).

**[Confirm TLS Certificate for LDAP Server Access]**

Select the check box to verify the certificate when encrypting communication with the LDAP server using TLS. Also, select the [Add CN to Verification Items] check box as necessary.

**■ Registering the authentication server**

If the use of the fax and scan functions is restricted, register the server used for authentication.

**[Server Name]**

Enter the name to be assigned to the LDAP server.

**[Server Address]**

Enter the IP address of the LDAP server or enter alphanumeric characters for the host name of the server (example: ldap.example.com).

**IMPORTANT:****[Server Address] and DNS**

- To prevent errors from occurring when searching for destinations, make sure to check the following:
  - If the host name is entered for [Server Address], make sure that a DNS server is available in the network.
  - If the IP address is entered for [Server Address], check whether the DNS server supports only forward lookup. If the server supports only forward lookup, select [Use] for [Login Information]. If you select [Use (Security Authentication)], make sure that the DNS server supports reverse lookup.

**[Position to Start Search]**

Specify the node in the directory information tree (DIT) that you want to start search from. Leaving the text box blank sets the machine to start search from an arbitrary node selected automatically.

- When specifying the node, enter "DC=," followed by a host name (a dot-delimited character string in the Active Directory domain name), and separate each of the entries with a comma. If the domain name is "john.example.com," for example, enter "DC=john,DC=example,DC=com."

**[Use TLS]**

Select the check box to encrypt communication with the LDAP server using TLS.

**NOTE:**

- This is enabled only when [Use] is selected in [Login Information].

**[Port Number]**

Enter the port number used for communicating with the LDAP server.

**[Authentication/Attribute Acquisition Timeout]**

Specify how long authentication and attribute acquisition can continue.

**[User Name Attribute]**

Enter the attribute name, to be compared with a user name entered during authentication, consisting of alphanumeric characters (Example: "sAMAccountName").

**NOTE:**

- Not required if [Use (Security Authentication)] is selected in [Login Information].

**[E-Mail Address Attribute]**

Enter the attribute name, to be used for obtaining an e-mail address from the authentication server, consisting of alphanumeric characters (Example: "mail").

**[Login Information]**

Select [Use] or [Use (Security Authentication)] depending on the type of authentication implemented by the LDAP server.

[Use]	Select to authenticate the machine using the System Manager ID.
[Use (Security Authentication)]	Select to use data obtained by Kerberos, a network authentication protocol, for the authentication password. If this setting is selected, the clock of the machine needs to be synchronized with that of the LDAP server.

**[Use System Manager ID]**

If [Use] is selected in [Login Information], this specifies whether authentication using the system manager ID is used. To use the system manager ID, select the check box and specify the user name and password used for authentication. If you deselect the check box, logins are anonymous (no user name).

**[User Name]**

Enter the user name of the machine that was registered to the LDAP server in the form "(domain name)\(user name)" (example: domain1\user1).

**[Set/Change Password]**

To specify or change the password, select the check box and enter alphanumeric characters in the [Password] text box.

**[Domain Name]**

When [Use (Security Authentication)] is selected for [Login Information], enter alphanumeric characters for the directory tree name in Active Directory (example: example.com).

**[Confirm TLS Certificate for LDAP Server Access]**

Select the check box to verify the certificate when encrypting communication with the LDAP server using TLS. Also, select the [Add CN to Verification Items] check box as necessary.

**6 Click [OK].**

**LINKS**

---

- ▶ **Configuring SNTP(P. 73)**
- ▶ **Basic Operations for Sending Faxes(P. 214)**
- ▶ **Basic Operations for Scanning Originals(P. 279)**
- ▶ **LDAP Server Authentication(P. 359)**

## Monitoring and Controlling the Machine with SNMP

261J-017

Simple Network Management Protocol (SNMP) is a protocol for monitoring and controlling communication devices in a network by using Management Information Base (MIB). The machine supports SNMPv1 and security-enhanced SNMPv3. You can check the status of the machine from a computer when you print documents or use the Remote UI. You can enable either SNMPv1 or SNMPv3, or both at the same time. Specify the settings for each version to suit your network environment and the purpose of use.

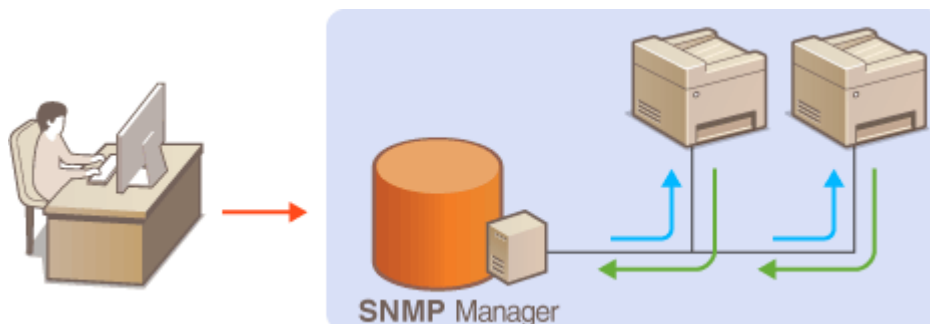

### SNMPv1

SNMPv1 uses information called "community" to define the scope of SNMP communication. Because this information is exposed to the network in plain text, your network will be vulnerable to attacks. If you want to ensure network security, disable SNMPv1 and use SNMPv3.

### SNMPv3

With SNMPv3, you can implement network device management that is protected by robust security features. Note that TLS must be enabled for the Remote UI before configuring SNMPv3 ( [▶Configuring the Key and Certificate for TLS\(P. 376\)](#) ).

## NOTE

- The machine does not support the trap notification feature of SNMP.
- To change the port number of SNMP, see [▶Changing Port Numbers\(P. 372\)](#) .
- SNMP management software, when installed on a computer on the network, enables you to configure, monitor, and control the machine remotely from the computer. For more information, see the instruction manuals for your management software.
- For more information about the basic operations to be performed when setting the machine from the Remote UI, see [▶Setting Up Menu Options from Remote UI\(P. 424\)](#) .

- 1 Start the Remote UI and log in to System Manager mode.** [▶Starting Remote UI\(P. 415\)](#)
- 2 Click [Settings/Registration] on the Portal page.** [▶Remote UI Screen\(P. 416\)](#)
- 3 Select [Network Settings] ▶ [SNMP Settings].**
- 4 Click [Edit].**

## 5 Specify SNMPv1 settings.

- If you do not need to change SNMPv1 settings, proceed to the next step.

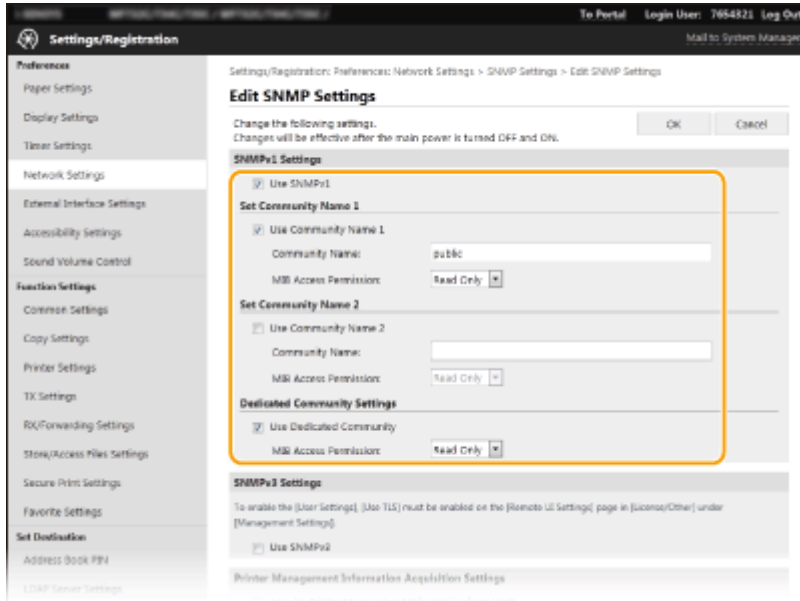

### [Use SNMPv1]

Select the check box to enable SNMPv1. You can specify the rest of SNMPv1 settings only when this check box is selected.

### [Use Community Name 1]/[Use Community Name 2]

Select the check box to specify a community name. If you do not need to specify a community name, clear the check box.

### [Community Name]

Enter alphanumeric characters for the name of the community.

### [MIB Access Permission]

For each community, select [Read/Write] or [Read Only] for the access privileges to MIB objects.

[Read/Write]	Permits both viewing and changing the values of MIB objects.
[Read Only]	Permits only viewing the values of MIB objects.

### [Use Dedicated Community]

Dedicated Community is a preset community, intended exclusively for Administrators using Canon software, such as iW Management Console. Select the check box to use Dedicated Community, and specify [MIB Access Permission]. If you do not need to use Dedicated Community, clear the check box.

## 6 Specify SNMPv3 settings.

- If you do not need to change SNMPv3 settings, proceed to the next step.

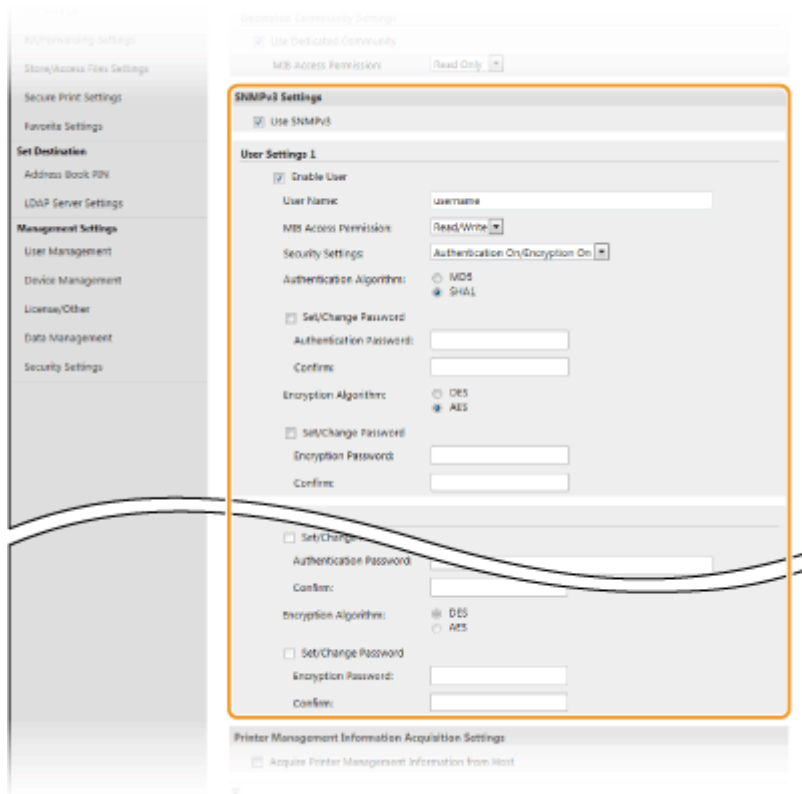

**[Use SNMPv3]**

Select the check box to enable SNMPv3. You can specify the rest of SNMPv3 settings only when this check box is selected.

**[Enable User]**

Select the check box to enable [User Settings 1]/[User Settings 2]/[User Settings 3]. To disable user settings, clear the corresponding check box.

**[User Name]**

Enter alphanumeric characters for the user name.

**[MIB Access Permission]**

Select [Read/Write] or [Read Only] for the access privileges to MIB objects.

[Read/Write]	Permits both viewing and changing the values of MIB objects.
[Read Only]	Permits only viewing the values of MIB objects.

**[Security Settings]**

Select [Authentication On/Encryption On], [Authentication On/Encryption Off], or [Authentication Off/Encryption Off] for the desired combination of authentication and encryption settings.

**[Authentication Algorithm]**

If you have selected [Authentication On/Encryption On] or [Authentication On/Encryption Off] in [Security Settings], select the appropriate authentication algorithm for your network environment.

**[Encryption Algorithm]**

If you have selected [Authentication On/Encryption On] in [Security Settings], select the appropriate encryption algorithm for your network environment.

**[Set/Change Password]**

To set or change the password, select the check box and enter alphanumeric characters for the password in the [Authentication Password] or [Encryption Password] text box. For confirmation, enter the same password in the [Confirm] text box. Passwords can be set independently for authentication and encryption algorithms.

**7 Specify Printer Management Information Acquisition Settings.**

- With SNMP, the printer management information, such as printing protocols and printer ports, can be monitored and obtained regularly from a computer on the network.

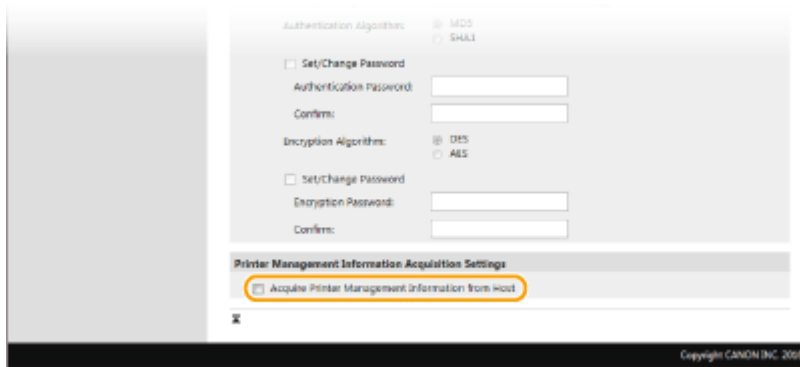

**[Acquire Printer Management Information from Host]**

Select the check box to enable monitoring of the printer management information of the machine via SNMP. To disable monitoring of the printer management information, clear the check box.

**8** Click [OK].

**9** Restart the machine.

- Turn OFF the machine, wait for at least 10 seconds, and turn it back ON.

**NOTE**

**Disabling SNMPv1**

- If SNMPv1 is disabled, some of the functions of the machine become unavailable, such as obtaining machine information via the printer driver.

**Using the operation panel**

- You can enable or disable the SNMP settings from <Menu>. ▶<SNMP Settings>(P. 466)

**Enabling Both SNMPv1 and SNMPv3**

- If both versions of SNMP are enabled, it is recommended that MIB access permission in SNMPv1 be set to [Read Only]. MIB access permission can be set independently in SNMPv1 and SNMPv3 (and for each user in SNMPv3). Selecting [Read/Write] (full access permission) in SNMPv1 negates the robust security features that characterize SNMPv3 because most of the machine settings can then be controlled with SNMPv1.

**LINKS**

- ▶<Configuring the Key and Certificate for TLS(P. 376)>



## Other Network Settings

261J-018

Configure the following items according to your network environment.

- ▶ **Configuring FTP PASV Mode(P. 73)**
- ▶ **Configuring SNTP(P. 73)**
- ▶ **Monitoring the Machine from the Device Management Systems(P. 74)**

### Configuring FTP PASV Mode

PASV is an FTP communication mode used for file transfer. To connect to an FTP server through a firewall, you must use PASV mode. First check that the PASV mode is set on the FTP server.

### IMPORTANT

- Whether PASV mode is used for FTP depends on your network environment and the settings on the FTP server to which data is being sent. For more information, contact your Network Administrator.



<Menu> ▶ <Preferences> ▶ <Network> ▶ <TCP/IP Settings> ▶ <Use FTP PASV Mode> ▶ <On>  
▶ <OK> ▶ Restart the machine

### Configuring SNTP

Simple Network Time Protocol (SNTP) enables you to adjust the system clock by using the time server on the network. If SNTP is used, the time server is checked at the specified intervals; therefore, the correct time can always be maintained. The time is adjusted based on Coordinated Universal Time (UTC), so specify the time zone setting before configuring SNTP ( ▶ **Setting the Date/Time(P. 12)** ). SNTP settings can be specified via the Remote UI.

### NOTE

- The SNTP of the machine supports both NTP (version 3) and SNTP (versions 3 and 4) servers.
- For more information about the basic operations to be performed when setting the machine from the Remote UI, see ▶ **Setting Up Menu Options from Remote UI(P. 424)** .

- 1 Start the Remote UI and log in to System Manager Mode. ▶ Starting Remote UI(P. 415)**
- 2 Click [Settings/Registration] on the Portal page. ▶ Remote UI Screen(P. 416)**
- 3 Select [Network Settings] ▶ [SNTP Settings].**
- 4 Click [Edit].**

## 5 Select the [Use SNTP] check box and specify the required settings.

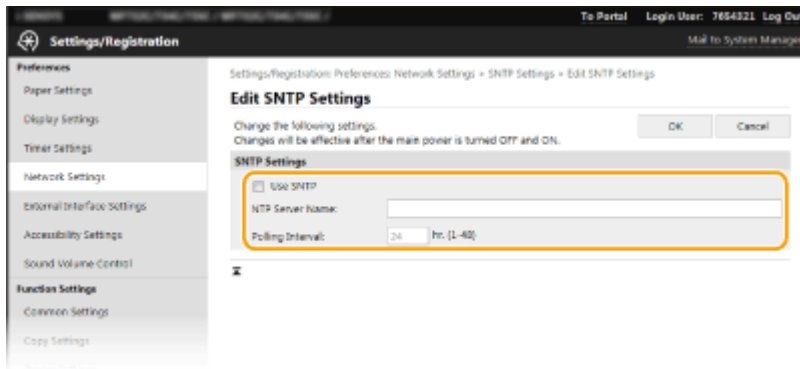

### [Use SNTP]

Select the check box to use SNTP for synchronization. If you do not want to use SNTP, clear the check box.

### [NTP Server Name]

Enter the IP address of the NTP or the SNTP server. If DNS is available on the network, you can enter a host name (or FQDN) consisting of alphanumeric characters instead (example: ntp.example.com).

### [Polling Interval]

Specify the interval between one synchronization and the next.

## 6 Click [OK].

## 7 Restart the machine.

- Turn OFF the machine, wait for at least 10 seconds, and turn it back ON.

## NOTE

### Testing communication with the NTP/SNTP server

- You can view communication status with the registered server by clicking [Settings/Registration] ► [Network Settings] ► [Check NTP Server] in [SNTP Settings]. If a proper connection has been established, the result is displayed as shown below. Note that this operation does not adjust the system clock.

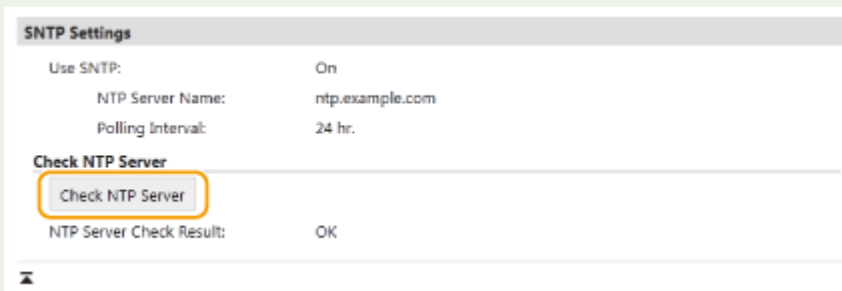

## Monitoring the Machine from the Device Management Systems

You can facilitate the collection and management of various information about networked devices by implementing device management software, such as iW Management Console\*, into the network. Information such as device settings and error logs is retrieved and distributed via the server computer. If the machine is connected to such a network, iW Management Console searches the network for the machine by using protocols such as Service Location Protocol (SLP) to gather information from the machine, such as power supply status information. SLP settings can be

specified via the Remote UI. This section also describes the procedure to configure settings for communication between the machine and plug-ins for iW Management Console.

\*For more information about iW Management Console, contact your local authorized Canon dealer.

## NOTE

### To use iW Management Console plug-ins

- You need to enable the settings of the dedicated port and the SNMP settings. As for the SNMP settings, set [MIB Access Permission] to [Read/Write] for both SNMPv1 and SNMPv3.

▶<Use Dedicated Port>(P. 467)

▶Monitoring and Controlling the Machine with SNMP(P. 69)

### Remote UI Operations

- For more information about the basic operations to be performed when setting the machine from the Remote UI, see ▶Setting Up Menu Options from Remote UI(P. 424) .

## ■ Configuring SLP Communication with Device Management Software

**1** Start the Remote UI and log in to System Manager Mode. ▶Starting Remote UI(P. 415)

**2** Click [Settings/Registration] on the Portal page. ▶Remote UI Screen(P. 416)

**3** Click [Network Settings].

**4** Specify SLP settings.

### ■ Specifying multicast device discovery

**1** Select [Multicast Discovery Settings] ▶ [Edit].

**2** Select the [Respond to Discovery] check box and specify the required settings.

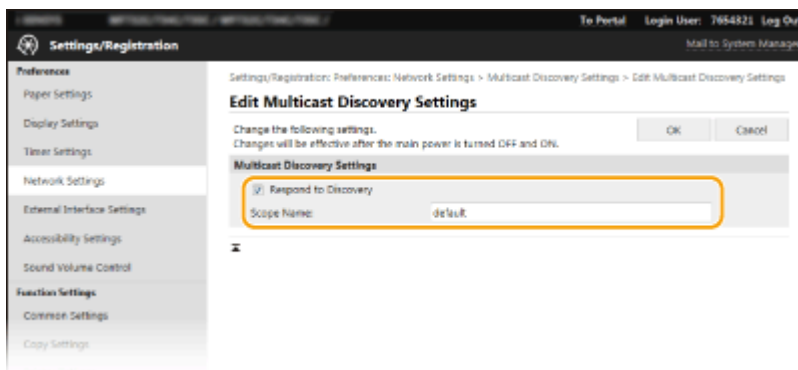

#### [Respond to Discovery]

Select the check box to set the machine to respond to device management software multicast discovery packets and enable monitoring by device management software.

**NOTE:**

- To change the port number for multicast discovery, see [▶ Changing Port Numbers\(P. 372\)](#) .

**[Scope Name]**

To include the machine into a specific scope, enter alphanumeric characters for the scope name.

- 3 Click [OK].

## ■ Notifying a device management software of the power status of the machine

- 1 Select [Sleep Mode Notification Settings] ▶ [Edit].
- 2 Select the [Notify] check box and specify the required settings.

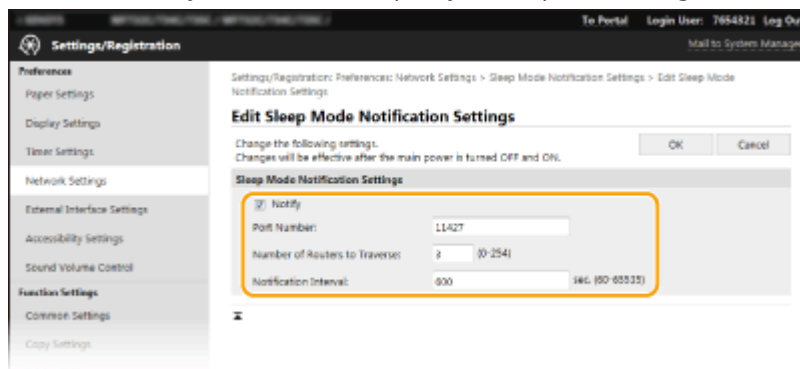
**[Notify]**

Select the check box to notify a device management software of the power status of the machine. When [Notify] is selected, you can expect the machine to avoid unnecessary communication during sleep mode and reduce the total power consumption.

**[Port Number]**

Change the port number for this function according to the network environment.

**[Number of Routers to Traverse]**

Specify how many routers the notification packets can pass through.

**[Notification Interval]**

Specify how often the machine notifies a device management software of its power status.

- 3 Click [OK].

## 5 Restart the machine.

- Turn OFF the machine, wait for at least 10 seconds, and turn it back ON.

## ■ Configuring Settings for Communication between the Machine and Plug-ins

You can specify the settings to enable communication between the machine and iW Management Console plug-ins. Use of plug-ins allows you to manage the machine's settings from iW Management Console.



<Menu> ▶ <Preferences> ▶ <Network> ▶ <Device Settings Management> ▶ <On> ▶ 

# Installing Drivers

---

261J-019

Install the various drivers and associated software on your computer.

## 1 Make the necessary preparation before proceeding with the installation.

- Install the optional devices on the main unit in advance. ▶ **Optional Equipment(P. 688)**
- If the machine is supplied with a CD-ROM/DVD-ROM, insert the CD-ROM/DVD-ROM into the drive on the computer.
- You can download drivers and software you are going to use from the Canon website (<http://www.canon.com/>).

### NOTE:

- When new versions of drivers and software become available, they will be uploaded to the Canon website. You can download them as necessary after checking their system requirements.
- Depending on your machine or environmental conditions, some functions may not be available.
- Some of the drivers are not supported depending on the OS. For more information about the supported status of the latest OS, see the Canon website.

## 2 Proceed with the installation.

- For more information about the installation procedure, see the manuals for the drivers and software you are going to use.

## IMPORTANT

- Installation of drivers is impossible if sending and receiving of the IP address are not permitted in [Firewall Settings]. For more information, see ▶ **Specifying IP Addresses for Firewall Settings(P. 366)** .
- If sending and receiving of the IP address of the computer on which drivers are installed become disabled by [Firewall Settings], it is no longer possible to perform printing or send faxes from that computer.

# Configuring Initial Settings for Fax Functions

261J-01A



Follow steps 1 to 4 described below to configure the fax settings. First, determine which receive mode best suits your intended use, and then follow the on-screen instructions to configure the settings. For more information about a particular step, click on the link to go to the corresponding section.

**Step 1****▶ Deciding Which Fax Receive Mode to Use(P. 80)****Step 2****▶ Registering the Fax Number and Unit Name(P. 81)****Step 3****▶ Selecting the Receive Mode(P. 82)****Step 4****▶ Connecting the Telephone Line(P. 83)**

## Deciding Which Fax Receive Mode to Use

261J-01C

Before configuring the fax settings, determine which receive mode best suits your intended use.

Intended use	Receive mode	
Use fax only/Never use telephone 	<b>&lt;Auto&gt;</b> This setting is for when you want to use the machine exclusively for receiving faxes, and you do not want to use the telephone or optional handset.	
Mostly use telephone/Almost never use fax 	<b>&lt;Manual&gt;</b> Connect your telephone or handset to the machine. This setting is for when you mostly want to use the telephone. You can receive incoming faxes manually.	
Use both fax and telephone 	Use answering machine	<b>&lt;Answering Machine&gt;</b> Connect your answering machine. Callers can record a message if they call while you are away from the telephone. The machine automatically receives incoming faxes.
	Use standard telephone or handset	<b>&lt;Fax/Tel (Auto Switch)&gt;</b> Connect your telephone or handset. The machine automatically receives incoming faxes, and the telephone rings for incoming calls.

### NOTE

- Depending on the type of telephone connected to it, the machine may not be able to send or receive faxes properly.
- You may be able to manually set receive modes other than those described above, depending on your country or region.  
 **Receiving Faxes(P. 223)**

» Continue to  **Registering the Fax Number and Unit Name(P. 81)**

### LINKS

 **Receiving Faxes(P. 223)**



## Registering the Fax Number and Unit Name

261J-01E

Register the fax number and unit name of your machine. This information is printed at the top of each page sent from the machine.

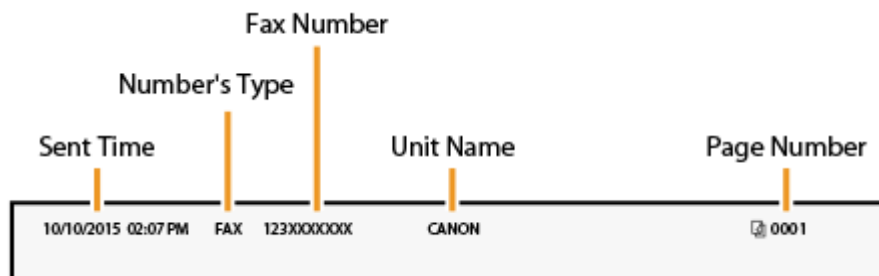

- 1** Select <Menu> in the Home screen. [▶Home Screen\(P. 121\)](#)
  - 2** Select <Function Settings> ▶ <Common> ▶ <Fax Setup Guide>.
  - 3** Select <Set Up Now>.
  - 4** Select <Next>.
  - 5** Enter the fax number, and select <Apply>.
  - 6** Select <Next>.
  - 7** Enter the unit name (such as a user name or company name), and select <Apply>.
    - On how to enter text, see [▶Entering Text\(P. 130\)](#) .
    - ⇒ When the unit name has been registered, the RX mode setting screen is displayed.
- » Continue to [▶Selecting the Receive Mode\(P. 82\)](#)

### LINKS

[▶Receiving Faxes\(P. 223\)](#)

## Selecting the Receive Mode

---

261J-01F

Select the receive mode that suits your intended use beforehand ( [▶Deciding Which Fax Receive Mode to Use\(P. 80\)](#) ).

### 1 Select <Next>.

### 2 Select the receive mode.

- Select <Yes> or <No> to select the receive mode for the operations you intend to carry out.

#### NOTE:

- You may be able to manually set receive modes other than those described below, depending on your country or region. [▶Receiving Faxes\(P. 223\)](#)

#### ■ To set the receive mode to <Auto>

Select <No>.

#### ■ To set the receive mode to <Answering Machine>

Select <Yes> ▶ <Yes>.

#### ■ To set the receive mode to <Fax/Tel (Auto Switch)>

Select <Yes> ▶ <No> ▶ <Yes>.

#### ■ To set the receive mode to <Manual>

Select <Yes> ▶ <No> ▶ <No>.

### 3 Select <Apply>.

⇒ When the RX mode has been set, the telephone line connection method is displayed.

### » Continue to [▶Connecting the Telephone Line\(P. 83\)](#)

#### LINKS

---

[▶Receiving Faxes\(P. 223\)](#)

# Connecting the Telephone Line

261J-01H

Connect the telephone line to the machine.

## 1 Connect the telephone line to the machine.

- Connect the included telephone cable to the telephone line jack on the machine (A) and the telephone line jack on the wall.
- If you are using a telephone or answering machine, connect it to the external telephone jack (B).
- If you are using an optional handset, connect it to the handset jack (C).

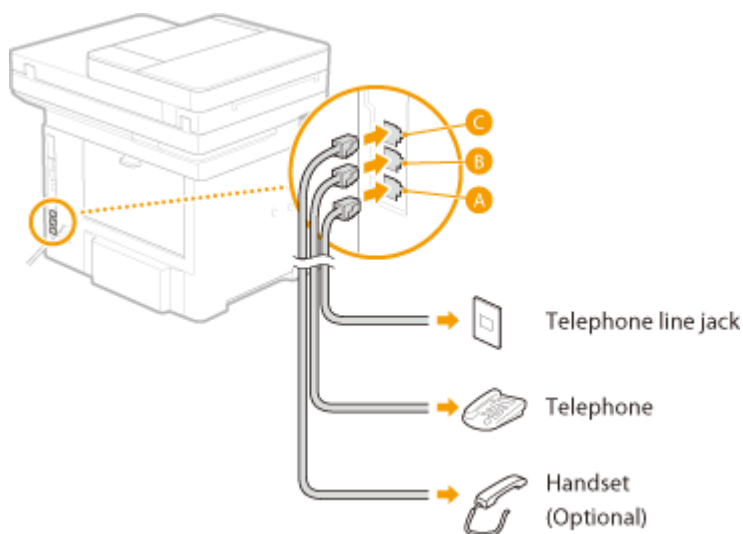

### NOTE:

- If you are connecting an external telephone with fax functions, set up the telephone to receive faxes manually.

## 2 Select <End> after the telephone line has been connected.

## 3 Select <Yes>.

### If the machine does not automatically set the type of telephone line

Follow the procedure below to set the type of telephone line. If you are not sure of the type of phone line you are using, contact your local telephone company. <Select Line Type> may not be available depending on the country where you are using the machine.



<Menu> ▶ <Function Settings> ▶ <Send> ▶ <Fax Settings> ▶ <Set Line> ▶ <Select Line Type> ▶  
 Select the type of telephone line ▶ 

### LINKS

- [Basic Operations for Sending Faxes\(P. 214\)](#)
- [Receiving Faxes\(P. 223\)](#)

## Configuring Scan Settings

261J-01J

To send scanned originals directly by e-mail or I-Fax or save them to shared folders or FTP server, you need to configure the network. The Send Function Setting Tool, an application that is included with the machine, will assist you with the required setup. Set the necessary configuration depending on your purpose and network environment.

### Saving to a Computer

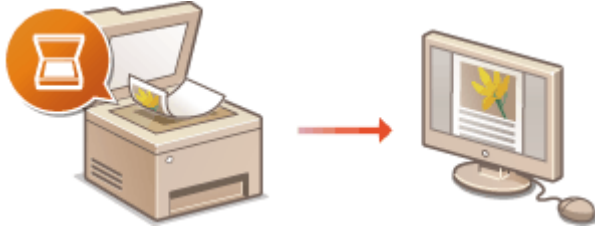

▶ [Preparing to Use the Machine as a Scanner\(P. 85\)](#)

### Scanning to E-mail or I-Fax



▶ [Procedure for Setting to Send E-Mail/Send and Receive I-Fax\(P. 86\)](#)

### Scanning to Shared Folders

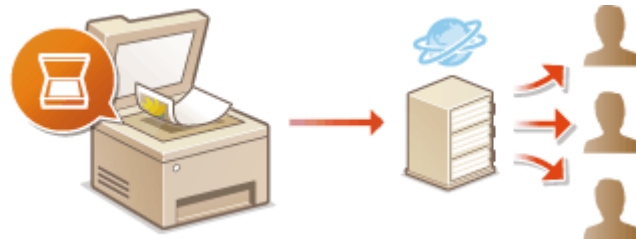

▶ [Procedure for Setting a Shared Folder as a Save Location\(P. 94\)](#)

### Saving to FTP Server



▶ [Procedure for Setting a FTP Server as a Save Location\(P. 98\)](#)

## LINKS

- ▶ [System Environment\(P. 684\)](#)
- ▶ [Scan Function\(P. 679\)](#)

## Preparing to Use the Machine as a Scanner

261J-01K

To use this machine as a scanner, you must complete preparations in advance, including installation of software to a computer. For more information, see the manuals for the relevant drivers on the online manual website. In Windows, when connecting this machine to a computer via a wireless or wired LAN, you need to register this machine in "MF Network Scanner Selector" using the following procedure. This procedure is not required if the machine and your computer are connected via USB.

### IMPORTANT

- The scan function is not available if the machine and your computer are connected in an IPv6 environment. Use IPv4 or a USB connection.

**1** Click  in the system tray.

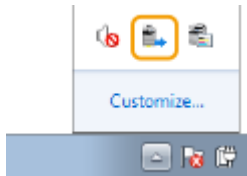

**2** Select the check box for the machine, and click [OK].

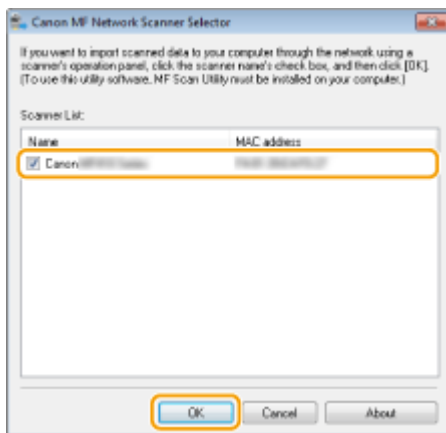

# Procedure for Setting to Send E-Mail/Send and Receive I-Fax

261J-01L

Before configuring the machine for scanning to e-mail, check the setup flow shown below.

1



**Make sure that the machine and the computer are correctly connected.**

▶ **Connecting to a Wireless LAN(P. 18)**

▶ **Connecting to a Wired LAN(P. 17)**



2



**Make sure that you have the following information:**

- The IP address of the machine. ▶ **Viewing Network Settings(P. 38)**
- An e-mail address to be registered as a destination.
- Information about the e-mail server, including the SMTP server name, port numbers, whether authentication is required, and the user name and password for authentication.

### NOTE:

- For more information about the e-mail server settings, contact your Internet service provider or Network Administrator.



3



**Make sure that the computer meets the system requirements for the Send Function Setting Tool (sending e-mail).**

- System requirements for the Send Function Setting Tool ▶ **System Environment(P. 684)**

### NOTE:

- Also make sure that <Use HTTP> and <Use Remote UI> are set to <On>.
  - ▶ **Disabling HTTP Communication(P. 410)**
  - ▶ **Disabling Remote UI(P. 411)**



4



**Set the machine configuration.**

- Configuring Basic E-Mail Settings ▶ **Configuring Basic E-Mail Settings(P. 87)**
- Configuring I-Fax Receiving Settings ▶ **Configuring E-Mail/I-Fax Communication Settings(P. 90)**
- Configuring Detailed E-Mail/I-Fax Communication Settings (Authentication, Encryption, etc.) ▶ **Configuring E-Mail/I-Fax Communication Settings(P. 90)**

# Configuring Basic E-Mail Settings

261J-01R

This section describes how to configure the e-mail settings by using the Send Function Setting Tool. With the Send Function Setting Tool, you can also register e-mail addresses to the Address Book.

## NOTE

- The Send Function Setting Tool helps you configure the basic settings for sending e-mails. Instead of the Send Function Setting Tool, you can use the Remote UI to configure more detailed settings such as the settings for POP authentication before sending or for encrypted communication. [▶Configuring E-Mail/I-Fax Communication Settings\(P. 90\)](#)

## 1 Start the Send Function Setting Tool.

### ■ Using a Web browser

Enter "http://<the IP address of the machine>/sendsupport\_login.html" in the address field of a Web browser, and press the [ENTER] key.

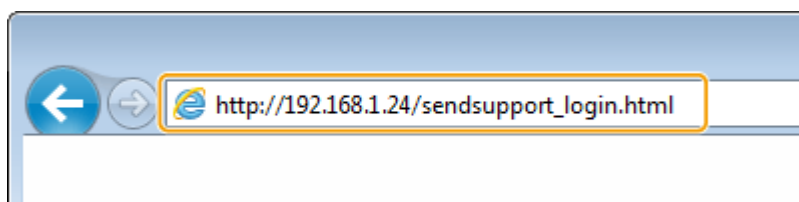

### ■ Using the CD-ROM/DVD-ROM

- 1 Insert the provided CD-ROM/DVD-ROM into the drive on the computer.
  - Select a language and click [OK] if you are prompted to do so.
- 2 Click [Start Software Programs].

#### NOTE:

- If the [Software Programs/Manuals Setup] screen is not displayed, see [▶Displaying the \[Software Programs/Manuals Setup\] Screen\(P. 700\)](#) .
- If [AutoPlay] is displayed, click [Run MInst.exe].

- 3 Click [Start] for [Send Function Setting Tool].
- 4 Click [Next].
  - If you want to view "Send Setting Guide," click [How to Set].

#### NOTE:

- If the screen that cancels the Windows firewall is displayed, click [Yes].

- 5 Select the machine from [Device List] and click [Next].

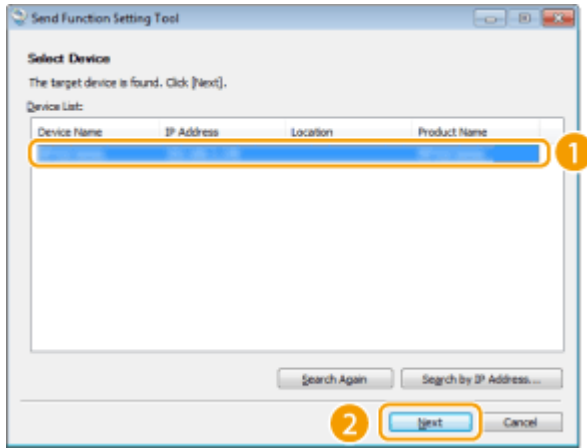

**NOTE:**

If the machine is not displayed in [Device List]

- Click [Search Again]. If the problem persists, click [Search by IP Address], enter the IP address of the machine, and then click [OK].

6 Confirm the settings and click [OK].

**2 Click [Start].**

- If the login screen is displayed, enter the appropriate ID and PIN in the corresponding text boxes, and then click [Logon].

**3 Click [Send to E-mail Settings].**

- If the screen prompting you to enter the Address Book PIN is displayed, enter the PIN for the Address Book, and click [OK]. ▶ **Restricting Use of the Address Book(P. 401)**

**4 Specify the required settings.**

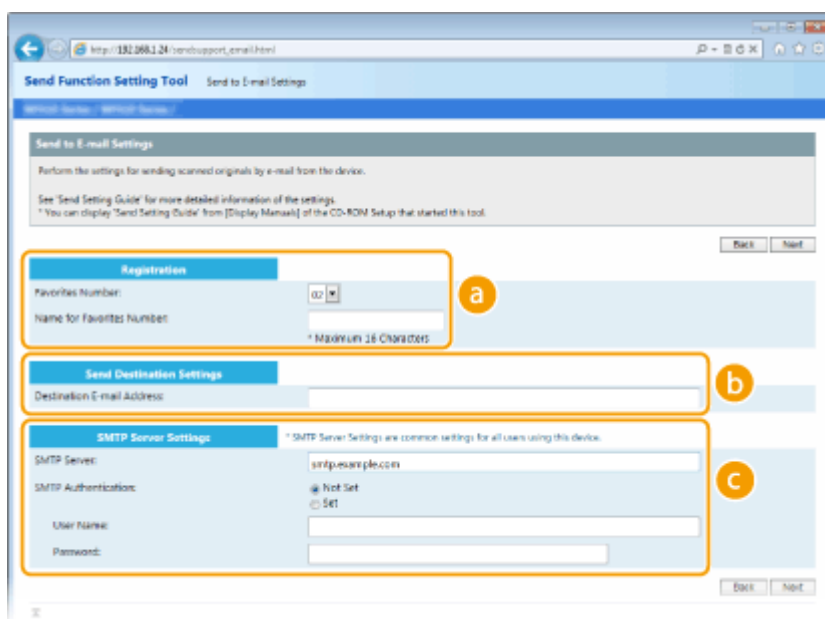

**a [Registration]**

**[Favorites Number]**



With the Send Function Setting Tool, you can register an e-mail address into <Favorites> in the Address Book. Select a number from the drop-down list.

**[Name for Favorites Number]**

Enter the name for identifying the destination to be registered. Set a name that will be easy for you to find later in the Address Book.

**b [Send Destination Settings]**

**[Destination E-mail Address]**

Enter the e-mail address that you want to send your scanned originals to.

**c [SMTP Server Settings]**

**[SMTP Server]**

Enter the SMTP server name.

**[SMTP Authentication]**

Click the [Not Set] or [Set] radio button to match the authentication settings of the SMTP server. When [Set] is selected, enter the user name in the [User Name] text box and password in the [Password] text box.

**NOTE:**

**Authentication methods for sending e-mails**

- To prevent e-mail transmissions by unauthorized users, the machine supports SMTP authentication (SMTP AUTH) and POP before SMTP. For more information about the required authentication method, contact your Internet service provider or Network Administrator.
- POP before SMTP authentication can only be configured by using the Remote UI. [▶Configuring E-Mail/I-Fax Communication Settings\(P. 90\)](#)

**5 Click [Next].**

**6 Confirm the settings and click [Register].**

**7 Restart the machine.**

- Turn OFF the machine, wait for at least 10 seconds, and turn it back ON.

**IMPORTANT**

Additional settings may be required depending on the network you are using. For more information, contact your Internet service provider or Network Administrator.

- To enable TLS for e-mailing, see [▶Configuring E-Mail/I-Fax Communication Settings\(P. 90\)](#) .
- To change port numbers, see [▶Changing Port Numbers\(P. 372\)](#) .

**LINKS**

- [▶Procedure for Setting to Send E-Mail/Send and Receive I-Fax\(P. 86\)](#)
- [▶Specifying E-Mail Settings\(P. 311\)](#)
- [▶Registering Destinations\(P. 176\)](#)

# Configuring E-Mail/I-Fax Communication Settings

261J-01S

Use the Remote UI to configure the detailed send and receive settings, such as the settings for using the machine to send and receive I-Faxes and the settings for POP authentication and encryption of communication before you send e-mail or I-Faxes. Contact your provider or network administrator for the required settings.

## NOTE

- For more information about the basic operations to be performed when setting the machine from the Remote UI, see [▶Setting Up Menu Options from Remote UI\(P. 424\)](#) .

- 1 Start the Remote UI and log in to System Manager Mode. ▶Starting Remote UI(P. 415)**
- 2 Click [Settings/Registration] on the Portal page. ▶Remote UI Screen(P. 416)**
- 3 Select [TX Settings] ▶ [Network Settings - E-Mail/I-Fax Settings].**
- 4 Click [Edit].**
- 5 Specify the required settings.**

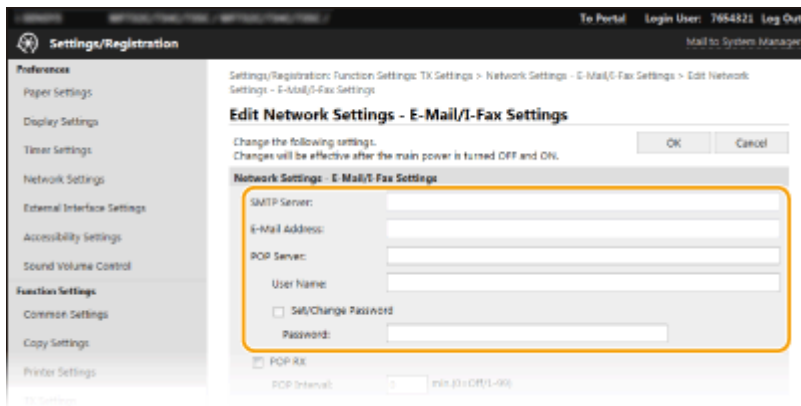

### [SMTP Server]

Enter alphanumeric characters as the SMTP server name (or IP address) for sending e-mail and I-Faxes.

### [E-Mail Address]

Enter alphanumeric characters for the e-mail address that you want to use for the machine.

### [POP Server]

Enter alphanumeric characters as the SMTP server name or IP address for sending e-mail and I-Faxes.

### [User Name]

Enter alphanumeric characters as the user name for the specified e-mail account when a POP3 server is used.

### [Set/Change Password]

To set or change the password when a POP3 server is used, select the check box and enter alphanumeric characters in [Password].

## ■ Specify the settings required for I-Fax reception

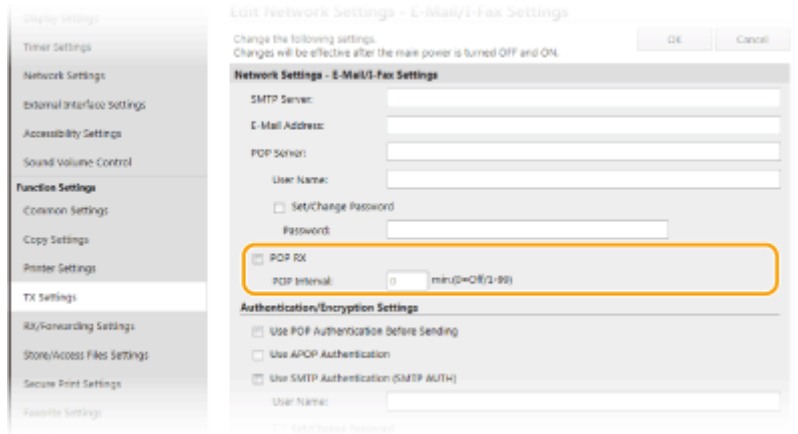

### [POP RX]

Select the check box to receive I-Faxes.

### [POP Interval]

This sets the interval (in minutes) used for automatically connecting to the POP3 server. If there are any I-Fax documents on the server, they are automatically received and printed.

## NOTE:

### To disable automatic reception

- Set [POP Interval] to [0]. When [0] is set, you receive I-Faxes manually. **▶ Receiving I-Faxes Manually (P. 251)**

## ■ Configuring Pop Authentication before Sending

POP before SMTP authentication prevents unauthorized users from using e-mail and I-Faxes by performing user authentication on the POP3 server.

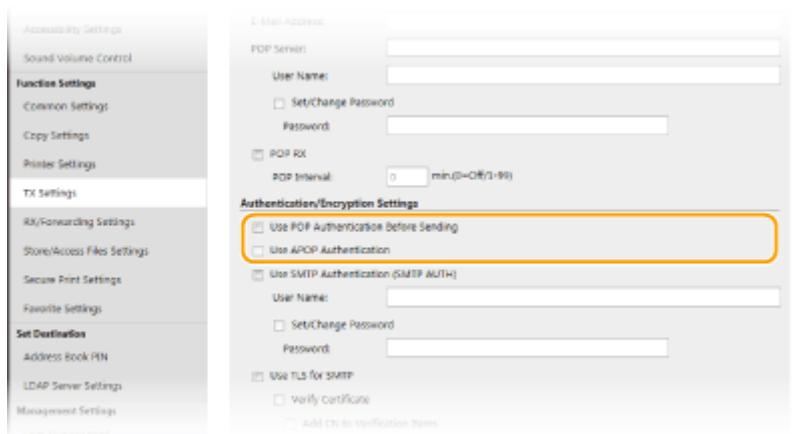

### [Use POP Authentication Before Sending]

To use the POP3 server for authentication before you send e-mail or I-Faxes, select the check box.

### [Use APOP Authentication]

Select the check box to use APOP to encrypt the password during the authentication process.

## ■ Configuring SMTP authentication

If you configure SMTP authentication (SMTP AUTH), user identification by user name and password is performed at the time of sending e-mail or I-Fax.

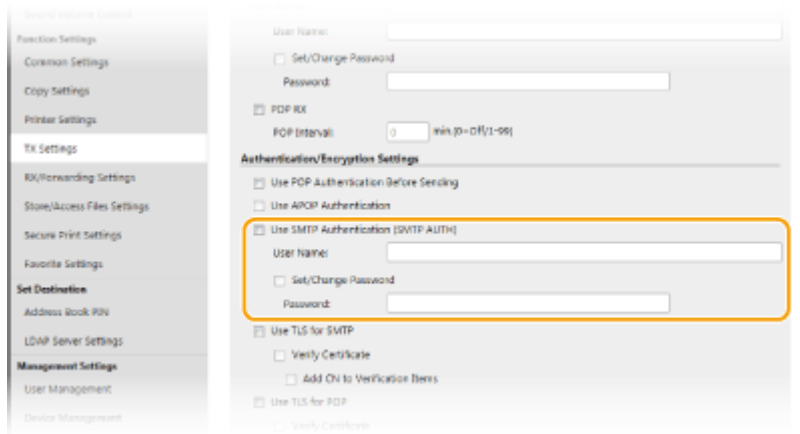

### [Use SMTP Authentication (SMTP AUTH)]

To enable authentication on the SMTP server, select the check box and enter alphanumeric characters in the [User Name] text box.

### [Set/Change Password]

To specify or change the password, enter alphanumeric characters in the [Password] text box.

## ■ Configuring encrypted communication

You can configure encryption of communication with an SMTP or POP3 server.

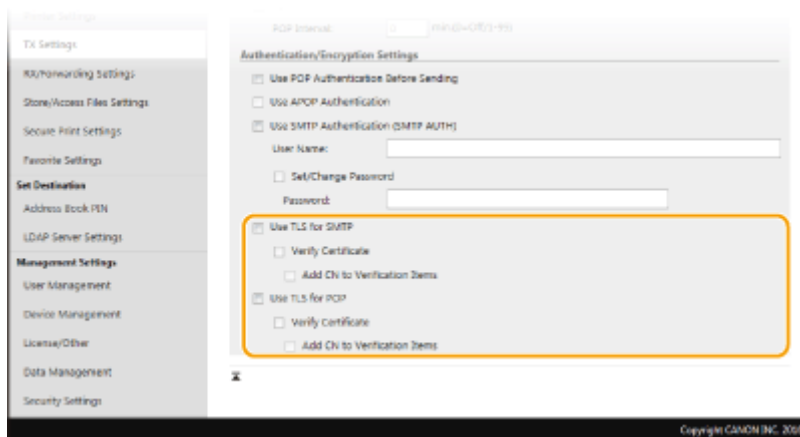

### [Use TLS for SMTP]

Select the check box to use TLS for encrypting communication with the SMTP server. Select the check box for [Verify Certificate] or [Add CN to Verification Items] depending on your needs.

### [Use TLS for POP]

Select the check box to encrypt communication with the POP3 server using TLS. Select the [Verify Certificate] and [Add CN to Verification Items] check boxes as required.

## 6 Click [OK].

## 7 Restart the machine.

- Turn OFF the machine, wait for at least 10 seconds, and turn it back ON.

## IMPORTANT

- Depending on the network you are using, you may need to change the SMTP or POP3 port setting ( ▶ **Changing Port Numbers(P. 372)** ). For more information, contact your Internet service provider or Network Administrator.

## LINKS

---

- ▶ **Procedure for Setting to Send E-Mail/Send and Receive I-Fax(P. 86)**
- ▶ **Configuring Basic E-Mail Settings(P. 87)**
- ▶ **Basic Operations for Scanning Originals(P. 279)**
- ▶ **Using Internet Fax (I-Fax)(P. 243)**

# Procedure for Setting a Shared Folder as a Save Location

Before configuring the machine for scanning to shared folders, check the setup flow shown below.

1



**Make sure that the machine and the computer are correctly connected.**

- ▶ **Connecting to a Wireless LAN(P. 18)**
- ▶ **Connecting to a Wired LAN(P. 17)**



2



**Make sure that you have the following information:**

- The IP address of the machine. ▶ **Viewing Network Settings(P. 38)**
- The name of the computer where the shared folder is located. ▶ **Checking the Computer Name(P. 702)**
- Path to and the name of the shared folder (If access restrictions are set to the folder, the user name and password information is also needed).

### NOTE:

- For instructions on how to create a new shared folder, see "Send Setting Guide".



3



**Make sure that the computer meets the system requirements for the Send Function Setting Tool.**

- System requirements for the Send Function Setting Tool ▶ **System Environment(P. 684)**

### NOTE:

- Also make sure that <Use HTTP> and <Use Remote UI> are set to <On>.
  - ▶ **Disabling HTTP Communication(P. 410)**
  - ▶ **Disabling Remote UI(P. 411)**



4



**Set the machine configuration.** ▶ **Setting a Shared Folder as a Save Location(P. 95)**

## Setting a Shared Folder as a Save Location

261J-01W

The feature of scanning to shared folders is also called "Scan to SMB" because the feature uses Server Message Block (SMB), a Windows-specific technology. SMB is a protocol for sharing resources, such as files and printers, with more than one device in a network ( [▶Configuring SMB\(P. 60\)](#) ). To configure the machine for saving your scanned documents into a shared folder in the network via SMB, specify the location of the shared folder from a computer in advance. This section describes how to specify the save location by using the Send Function Setting Tool.

### NOTE

- You can also use the Remote UI to specify the location of the shared folder as save destination by registering the folder to the Address Book. Registering Destinations in the Address Book from Remote UI. [▶Registering Destinations from Remote UI\(P. 427\)](#)

### 1 Start the Send Function Setting Tool.

#### ■Using a Web browser

Enter "http://<the IP address of the machine>/sendsupport\_login.html" in the address field of a Web browser, and press the [ENTER] key.

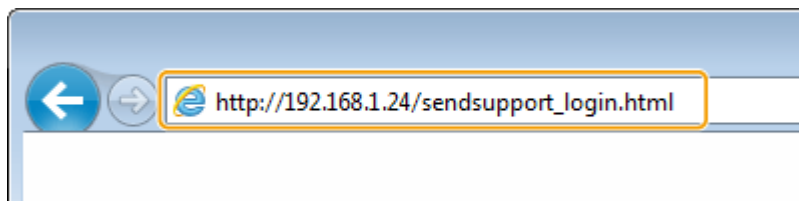

#### ■Using the CD-ROM/DVD-ROM

- 1 Insert the provided CD-ROM/DVD-ROM into the drive on the computer.
  - Select a language and click [OK] if you are prompted to do so.
- 2 Click [Start Software Programs].

### NOTE:

- If the [Software Programs/Manuals Setup] screen is not displayed, see [▶Displaying the \[Software Programs/Manuals Setup\] Screen\(P. 700\)](#) .
- If [AutoPlay] is displayed, click [Run MInst.exe].

- 3 Click [Start] for [Send Function Setting Tool].
- 4 Click [Next].
  - If you want to view "Send Setting Guide," click [How to Set].

### NOTE:

- If the screen that cancels the Windows firewall is displayed, click [Yes].

- 5 Select the machine from [Device List] and click [Next].

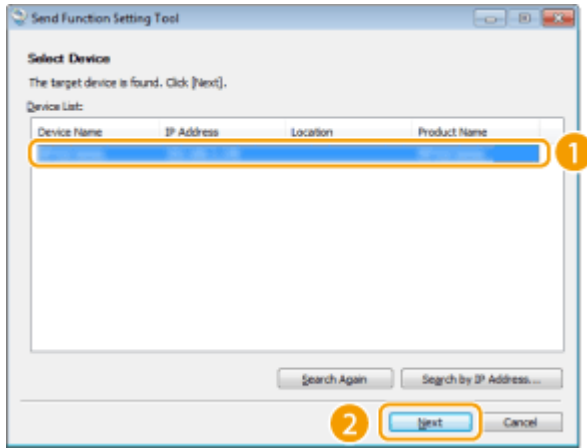

**NOTE:**

**If the machine is not displayed in [Device List]**

- Click [Search Again]. If the problem persists, click [Search by IP Address], enter the IP address of the machine, and then click [OK].

**6** Confirm the settings and click [OK].

**2 Click [Start].**

- If the login screen is displayed, enter the appropriate ID and PIN in the corresponding text boxes, and then click [Logon].

**3 Click [Store to Shared Folder Settings].**

- If the screen prompting you to enter the Address Book PIN is displayed, enter the PIN for the Address Book, and click [OK]. **▶Restricting Use of the Address Book(P. 401)**

**4 Specify the required settings.**

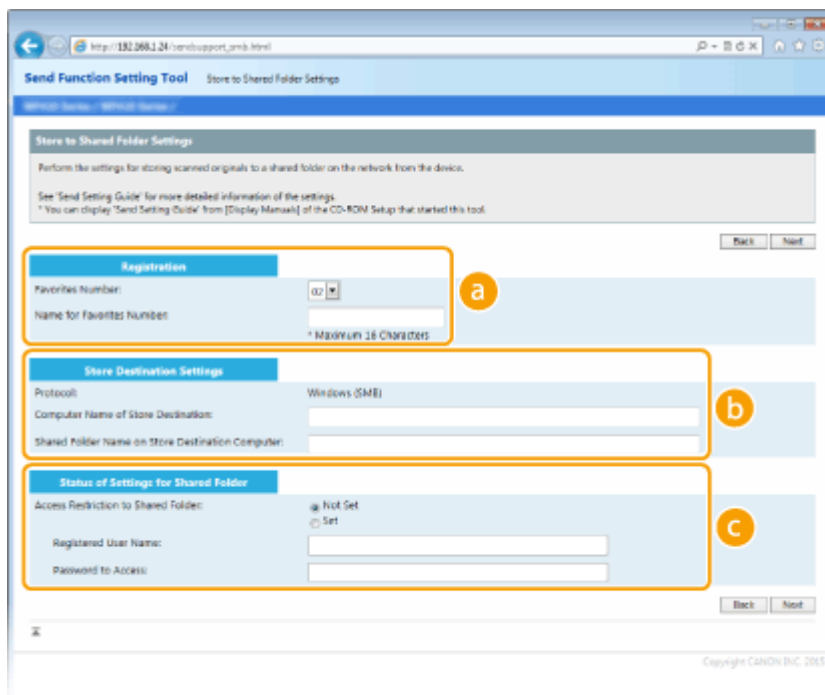

**a [Registration]**



**[Favorites Number]**

With the Send Function Setting Tool, you can register a shared folder for saving scanned documents into <Favorites> in the Address Book. Select a number from the drop-down list.

**[Name for Favorites Number]**

Enter the name for identifying the destination to be registered. Set a name that will be easy for you to find later in the Address Book.

**b [Store Destination Settings]**

**[Protocol]**

The protocol that is used for sending scanned documents to a shared folder is displayed.

**[Computer Name of Store Destination]**

Enter the name or the IP address of the computer where the shared folder is located.

**[Shared Folder Name on Store Destination Computer]**

Enter the name of (or path to) the shared folder. For example, if the shared folder is a subfolder named "share" and is contained in the [Public] folder in drive C (path: C:\users\public\share), enter "users\public\share."

**c [Status of Settings for Shared Folder]**

**[Access Restriction to Shared Folder]**

Click the [Not Set] or [Set] radio button to match the access restrictions set to the shared folder. When [Set] is selected, enter the user name in the [Registered User Name] text box and password in the [Password to Access] text box.

**5 Click [Next].**

**6 Confirm the settings and click [Register].**

**7 Restart the machine.**

- Turn OFF the machine, wait for at least 10 seconds, and turn it back ON.

**LINKS**

---

▶ **Procedure for Setting a Shared Folder as a Save Location(P. 94)**

▶ **Basic Operations for Scanning Originals(P. 279)**

# Procedure for Setting a FTP Server as a Save Location

261J-01X

Before configuring the machine for scanning to FTP Server, check the setup flow shown below.

1



**Make sure that the machine and the computer are correctly connected.**

- ▶ **Connecting to a Wireless LAN(P. 18)**
- ▶ **Connecting to a Wired LAN(P. 17)**



2



**Make sure that you have the following information:**

- The IP address of the machine. ▶ **Viewing Network Settings(P. 38)**
- FTP server name.
- Path to the FTP server and folder name.
- User name, password (only if set).

### NOTE:

- If the path, folder name, user name, password, etc. for the FTP server are unknown, contact you Network Administrator.
- To change the FTP port number. ▶ **Changing Port Numbers(P. 372)**



3



**Check whether you need to use PASV mode.**

- If a firewall is installed between the machine and the FTP server, you must set PASV mode. ▶ **Configuring FTP PASV Mode(P. 73)**

### NOTE:

- Also make sure that <Use HTTP> and <Use Remote UI> are set to <On>.
  - ▶ **Disabling HTTP Communication(P. 410)**
  - ▶ **Disabling Remote UI(P. 411)**



4



**Register the FTP server address.**

- ▶ **Registering Destinations from Remote UI(P. 427)**

# Basic Operations

<b>Basic Operations</b> .....	101
<b>Parts and Their Functions</b> .....	105
Front Side .....	106
Back Side .....	108
Interior .....	109
Feeder .....	110
Multi-Purpose Tray .....	111
Paper Drawer .....	112
Operation Panel .....	113
<b>Turning ON the Machine</b> .....	115
Turning OFF the Machine .....	116
Powering OFF at a Fixed Time .....	117
<b>Using the Operation Panel</b> .....	119
Basic Screens .....	120
Home Screen .....	121
<Status Monitor> Screen .....	124
Message Display .....	126
Basic Operation .....	127
Entering Text .....	130
<b>Logging in to the Machine</b> .....	132
<b>Placing Originals</b> .....	134
<b>Loading Paper</b> .....	138
Loading Paper in the Paper Drawer .....	140
Loading Paper in the Multi-Purpose Tray .....	145
Loading Envelopes .....	148
Loading Preprinted Paper .....	150
Specifying Paper Size and Type .....	154
Specifying Paper Size and Type in the Paper Drawer .....	155
Specifying Paper Size and Type in the Multi-Purpose Tray .....	157
Registering Default Paper Settings for the Multi-Purpose Tray .....	159
Registering a Custom Paper Size .....	161
Limiting the Paper Sizes Displayed .....	162
Automatically Selecting an Appropriate Paper Source for Each Function .....	163
<b>Customizing the Display</b> .....	164
Customizing the Home Screen .....	165

Registering Frequently Used Settings .....	168
<b>Changing the Default Settings for Functions</b> .....	170
<b>Setting Sounds</b> .....	172
<b>Entering Sleep Mode</b> .....	174
<b>Registering Destinations</b> .....	176
Registering Destinations in the Address Book .....	178
Registering Multiple Destinations as a Group .....	181
Editing the Registered Destinations in the Address Book .....	183
<b>Using a USB Memory Device</b> .....	184

# Basic Operations

---

261J-01Y

This chapter describes basic operations, such as how to use the operation panel or how to load the paper, that are frequently performed to use the functions of the machine.

## ■ Parts and Their Functions

This section describes the exterior and interior parts of the machine and their functions, as well as how to use the keys on the operation panel and how to view the display. ▶ **Parts and Their Functions(P. 105)**



## ■ Turning ON the Machine

This section describes how to turn the machine ON and OFF. ▶ **Turning ON the Machine(P. 115)**



## ■ Using the Operation Panel

This section describes how to use the display for tasks such as selecting items and adjusting settings. Also, it describes how to enter characters and numbers. ▶ **Using the Operation Panel(P. 119)**

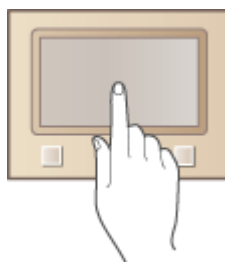

## ■ Logging in to the Machine

This section describes how to log in when a login screen is displayed. ▶ **Logging in to the Machine(P. 132)**

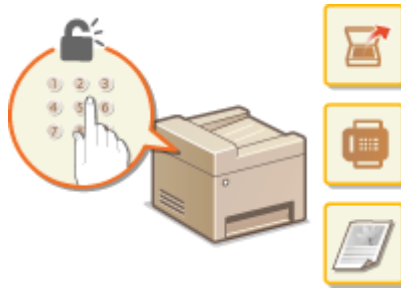

### ■ Placing Originals

This section describes how to place originals on the platen glass and in the feeder. **▶Placing Originals(P. 134)**



### ■ Loading Paper

This section describes how to load the paper into the paper drawer and multi-purpose tray. **▶Loading Paper(P. 138)**

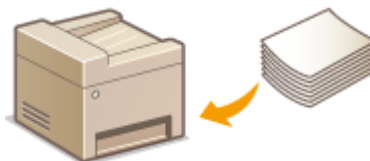

### ■ Customizing the Display

This section describes how to rearrange buttons or create shortcut buttons in order to make it easier to use screens shown in the display. **▶Customizing the Display(P. 164)**



### ■ Changing the Default Settings for Functions

This section describes how to change the setting that is displayed initially when a function is selected. **▶Changing the Default Settings for Functions(P. 170)**



### ■ Setting Sounds

This section describes how to adjust the volume of various machine sounds, such as those produced when fax sending is complete or when an error occurs. ▶ **Setting Sounds(P. 172)**



### ■ Entering Sleep Mode

This section describes how to set the sleep mode. ▶ **Entering Sleep Mode(P. 174)**



### ■ Registering Destinations

This section describes how to register destinations for sending faxes or scanned documents. ▶ **Registering Destinations(P. 176)**

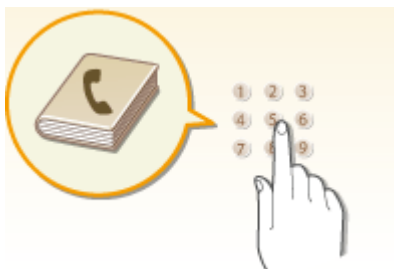

### ■ Using a USB Memory Device

This section describes about the available USB memory devices and how to insert/remove the USB memory device. ▶ **Using a USB Memory Device(P. 184)**

## Basic Operations

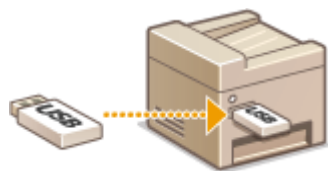



## Parts and Their Functions

---

261J-020

This section describes the parts of the machine (exterior, front and back side, and interior) and how they function. In addition to describing the parts of the machine used for such basic operations as loading paper and replacing the toner cartridges, this section also describes the keys on the operation panel and display. Read this section for tips on how to use the machine properly.



- ▶ **Front Side(P. 106)**
- ▶ **Back Side(P. 108)**
- ▶ **Interior(P. 109)**
- ▶ **Feeder(P. 110)**
- ▶ **Multi-Purpose Tray(P. 111)**
- ▶ **Paper Drawer(P. 112)**
- ▶ **Operation Panel(P. 113)**

## Front Side

261J-021

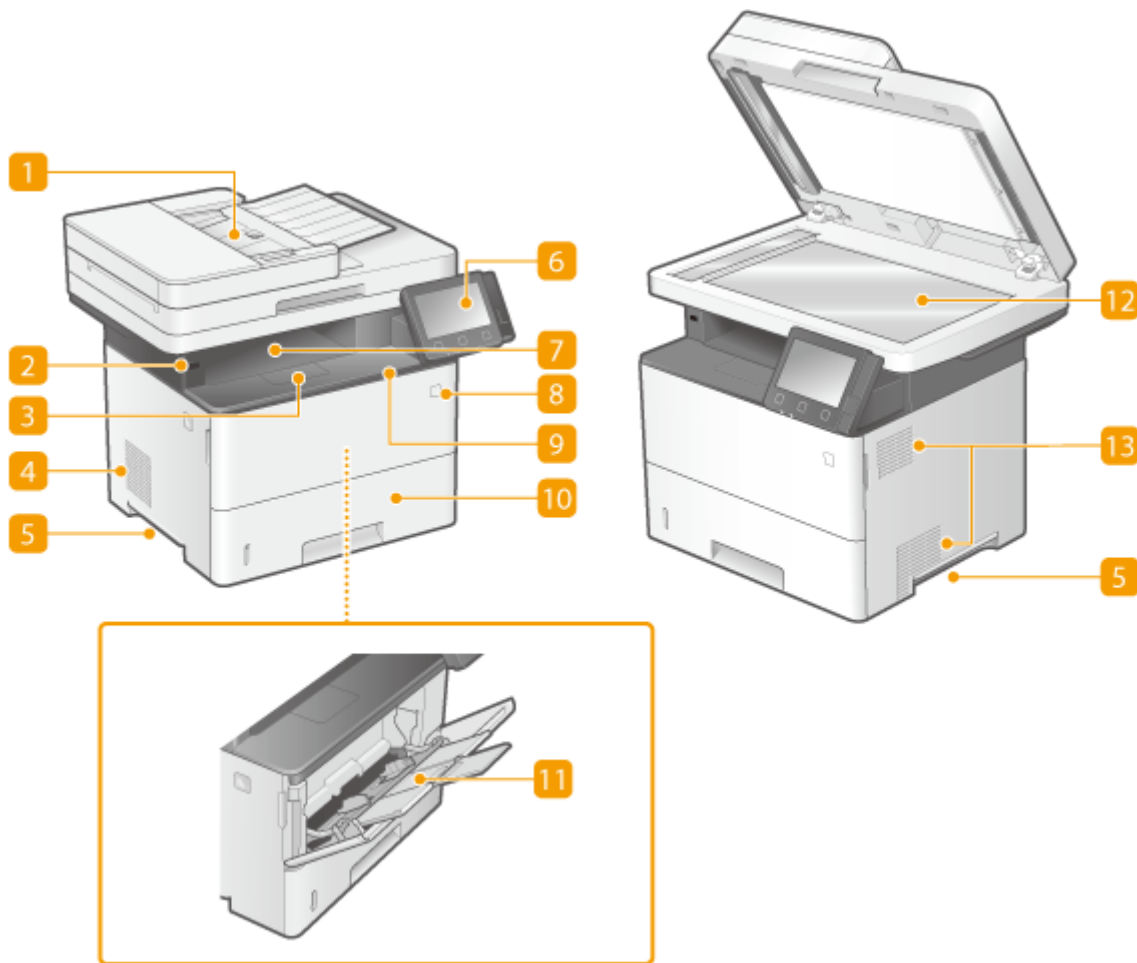

### 1 Feeder

Automatically feeds originals into the machine for scanning. When two or more sheets of original are loaded in the feeder, originals can be scanned continuously. **▶Feeder(P. 110)**

### 2 USB port (for USB device connection)

Use this port to connect a third-party USB memory device or USB keyboard. Connecting a USB memory device allows you to print data from the memory device or store scanned originals on the memory device.

- ▶**Printing from a USB Memory Device (Memory Media Print)(P. 265)**
- ▶**Sending Data by E-Mail/Saving Data to a Shared Folder or FTP Server(P. 286)**

### 3 Paper stopper

Open the paper stopper when you want to prevent paper from falling out of the output tray.

### 4 Speaker

Emits sounds produced by the machine, such as fax tones and warning tones.

## 5 Lift handles

Hold the lift handles when carrying the machine. ▶ **Relocating the Machine(P. 570)**

## 6 Operation panel

The operation panel consists of keys such as Home key, Stop key, a display, and status indicators. You can perform all the operations and specify settings from the operation panel.

▶ **Operation Panel(P. 113)**

▶ **Basic Screens(P. 120)**

## 7 Output tray

Printed paper is output to the output tray.

## 8 Power switch

Turns the power ON or OFF. To restart the machine, turn OFF the machine, wait for at least 10 seconds, and turn it back ON.

## 9 Front cover

Open the front cover when replacing the toner cartridge or clearing paper jams.

▶ **Procedure for Replacing the Toner Cartridge(P. 567)**

▶ **Clearing Paper Jams(P. 642)**

## 10 Paper drawer

Load the type of paper you frequently use into the paper drawer. ▶ **Loading Paper in the Paper Drawer(P. 140)**

## 11 Multi-purpose tray

Load the paper into the multi-purpose tray when you want to temporarily use a type of paper different from that which is loaded in the paper drawer. ▶ **Loading Paper in the Multi-Purpose Tray(P. 145)**

## 12 Platen glass

When scanning books, originals of heavy or thin paper and other originals that cannot be scanned using the feeder, place them on the platen glass. ▶ **Placing Originals(P. 134)**

## 13 Ventilation slots

Air inside the machine is vented out to cool down the inside of the machine. Note that placing objects in front of the ventilation slots prevents ventilation.

## Back Side

261J-023

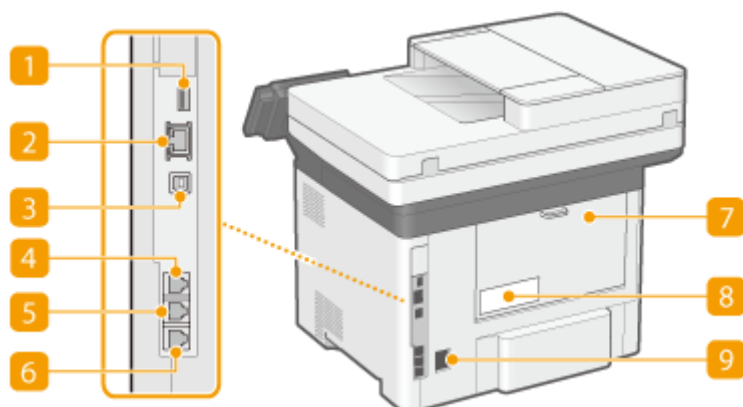

### 1 USB port (for USB device connection)

Use this port to connect devices such as a third-party USB keyboard.

### 2 LAN port

Connect a LAN cable when connecting the machine to a wired LAN router, etc. ▶ **Connecting to a Wired LAN(P. 17)**

### 3 USB port (for computer connection)

Connect a USB cable when connecting the machine and a computer.

### 4 Handset jack

Connect an optional handset.

### 5 External telephone jack

Connect your telephone or answering machine. ▶ **Connecting the Telephone Line(P. 83)**

### 6 Telephone line jack

Connect a telephone cable when connecting the machine to a telephone line. ▶ **Connecting the Telephone Line(P. 83)**

### 7 Rear cover

Open the rear cover when clearing paper jams. ▶ **Clearing Paper Jams(P. 642)**

### 8 Rating label

The label shows the serial number, which is needed when making inquiries about the machine. ▶ **When a Problem Cannot Be Solved(P. 654)**

### 9 Power socket

Connect the power cord.

# Interior

261J-024

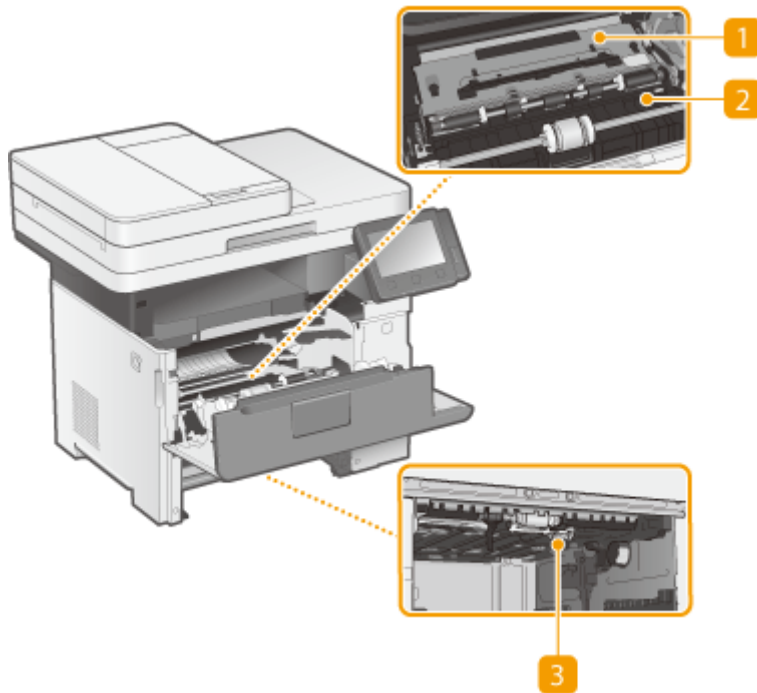

## 1 Transport guide (at the back)

If there is a paper jam inside the machine, raise the transport guide toward the front of the machine to remove the jammed paper. ▶ **Clearing Paper Jams(P. 642)**

## 2 Transport guide (at the front)

If there is a paper jam inside the machine, raise the transport guide toward the back of the machine to remove the jammed paper. ▶ **Clearing Paper Jams(P. 642)**

## 3 Duplex transport guide

If paper has jammed during 2-sided printing, lower the duplex transport guide to remove the jammed paper. ▶ **Clearing Paper Jams(P. 642)**

## Feeder

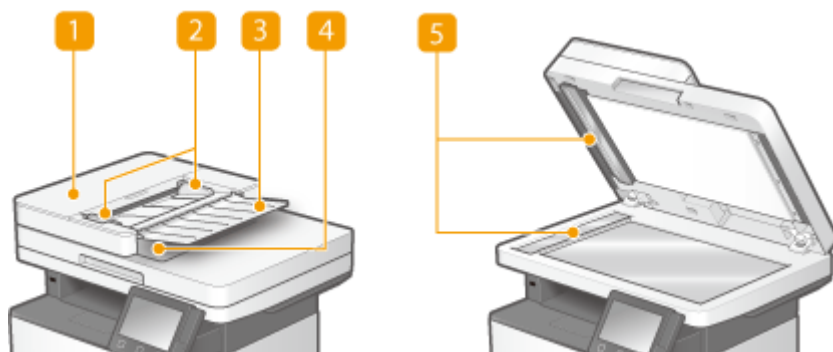

### 1 Feeder cover

Open when clearing paper jams. ▶ **Paper Jams in the Feeder(P. 644)**

### 2 Slide guides

Adjust these guides to match the width of original.

### 3 Original supply tray

Automatically feeds originals into the machine for scanning. When two or more sheets of original are loaded in the feeder, originals can be scanned continuously. ▶ **Placing Originals(P. 134)**

### 4 Original output tray

Scanned originals are output here.

### 5 Document feed scanning area

Originals loaded in the feeder are automatically fed to the scanning area to be scanned.

## IMPORTANT

- Do not place any objects in the original output area. Doing so may cause damage to the originals.
- Regularly clean the feeder and platen glass in order to obtain proper print results. ▶ **Regular Cleaning(P. 559)**

## Multi-Purpose Tray

---

261J-026

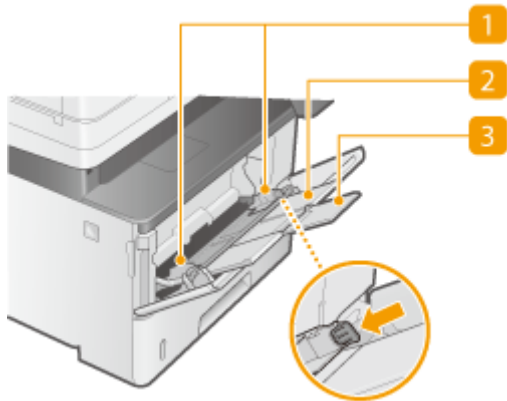

### 1 Paper guides

Adjust the paper guides to exactly the width of the loaded paper to ensure that paper is fed straight into the machine. Press the lock release lever that is indicated with an arrow in the illustration to release the lock and slide the paper guides.

### 2 Paper tray

Pull out the paper tray when loading paper.

### 3 Tray extension

Open the tray extension when loading large paper.

## LINKS

---

▶ [Loading Paper in the Multi-Purpose Tray\(P. 145\)](#)

## Paper Drawer

261J-027

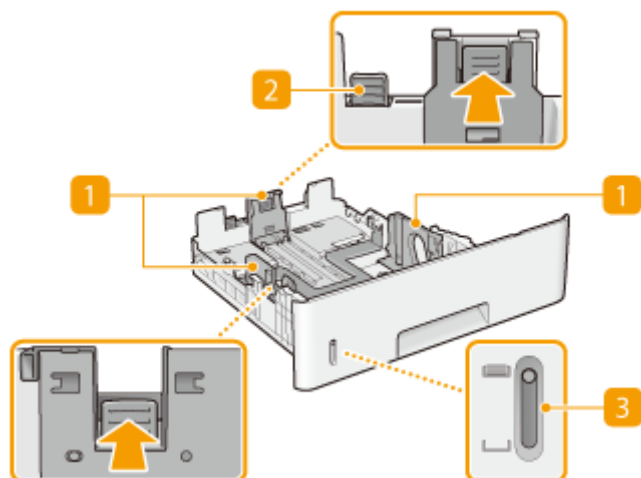

### 1 Paper guides

Adjust the paper guides to exactly the size of the loaded paper to ensure that paper is fed straight into the machine. Press the lock release levers that are indicated with arrows in the illustrations to release the locks and slide the paper guides.

### 2 Lock release lever (for extending the paper drawer)

When loading Legal size paper, the paper drawer needs to be extended. Press this lever to release the lock and extend the length of the paper drawer.

### 3 Paper level indicator

Indicates the remaining amount of paper. The mark moves downward as the remaining amount of paper decreases.

## LINKS

▶ **Loading Paper in the Paper Drawer(P. 140)**



# Operation Panel

261J-028

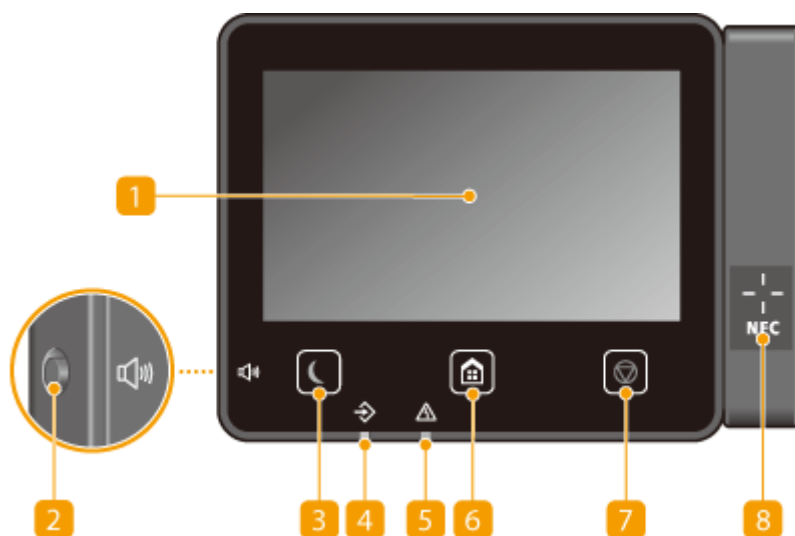

## NOTE

- The angle of the operation panel can be adjusted. Adjust it to an angle that is most comfortable for viewing the panel. ▶ **Adjusting the Angle(P. 114)**

### 1 Display

You can view the progress of the machine and error statuses. The display is also a touch panel, so you can specify settings by touching the screen directly.

- ▶ **Basic Screens(P. 120)**
- ▶ **Basic Operation(P. 127)**

### 2 Sound Volume key

Press to adjust volume. ▶ **Setting Sounds(P. 172)**

### 3 Energy Saver key

Press to put the machine into the sleep mode. The key lights up green when the machine is in the sleep mode. Press the key again to exit sleep mode. ▶ **Entering Sleep Mode(P. 174)**

### 4 Data indicator

Blinks while an operation is being performed, such as data transmission or printing. Lights up when there are documents waiting to be processed.

### 5 Error indicator

Blinks or lights up when an error such as a paper jam occurs.

### 6 Home key

Press to display the Home screen, which provides access to the setting menu and functions such as copy and scan.

- ▶ **Home Screen(P. 121)**

▶ **Customizing the Home Screen(P. 165)**

## **7 Stop key**

Press to cancel printing and other operations.

## **8 NFC (Near Field Communication) mark**

You can also use functions such as printing by waving a mobile device with Canon PRINT Business installed over this mark. ▶ **Connecting with Mobile Devices(P. 320)**

## **Adjusting the Angle**

---

When it is difficult to view the touch panel display, adjust the angle of the operation panel.

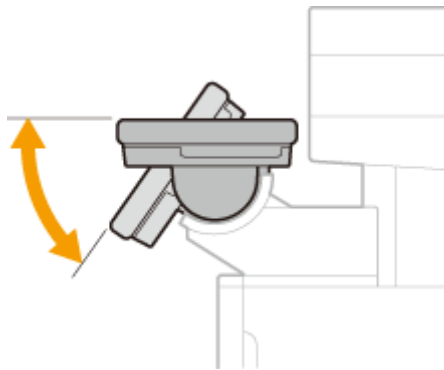

## LINKS

---

▶ **Basic Operation(P. 127)**

# Turning ON the Machine

---

261J-029

This section describes how to turn ON the machine.

- 1** Make sure that the power plug is firmly inserted into a power outlet.
- 2** Press the power switch.

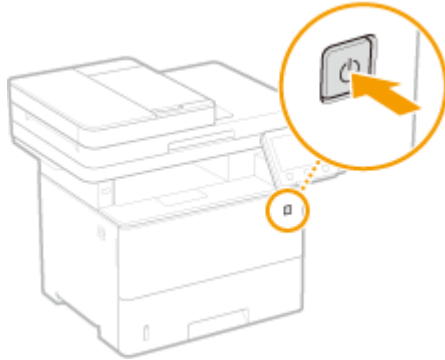

⇒ The Start screen appears. ▶ **Operation Panel(P. 113)**

## NOTE

- You can select the screen that is displayed first after the machine is turned ON. ▶ **<Default Screen After Startup/Restoration>(P. 447)**

## LINKS

---

▶ **Turning OFF the Machine(P. 116)**

## Turning OFF the Machine

261J-02A

This section describes how to turn OFF the machine.

### 1 Press the power switch.

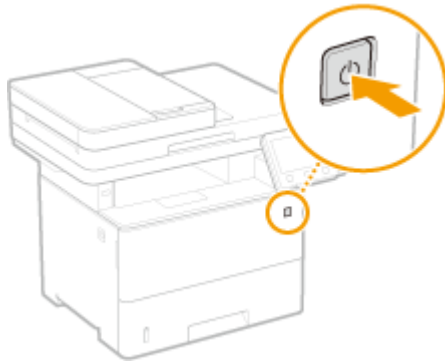

### NOTE

- It may take some time for the machine to completely shut down. Do not unplug the power cord until the display turns off.
- To restart the machine, wait for at least 10 seconds after the machine is turned OFF.
- You can specify the time for each day of the week and configure a setting to automatically turn OFF the machine. **▶ Powering OFF at a Fixed Time(P. 117)**

## Powering OFF at a Fixed Time

261J-02C

You can make a setting so that the power is automatically turned OFF at a specified time on each day of the week. This allows you to avoid useless power consumption that may occur due to failure to turn OFF the power. By default, this function is disabled.

### NOTE

- For information about the basic operation to set up the machine from Remote UI, see [▶Setting Up Menu Options from Remote UI\(P. 424\)](#).

- 1 Start the Remote UI and log in to System Manager Mode. [▶Starting Remote UI\(P. 415\)](#)
- 2 Click [Settings/Registration] on the Portal page. [▶Remote UI Screen\(P. 416\)](#)
- 3 Select [Timer Settings] ▶ [Edit].
- 4 Select the check box for [Set Auto Shutdown Weekly Timer], and set the time to turn OFF the power.

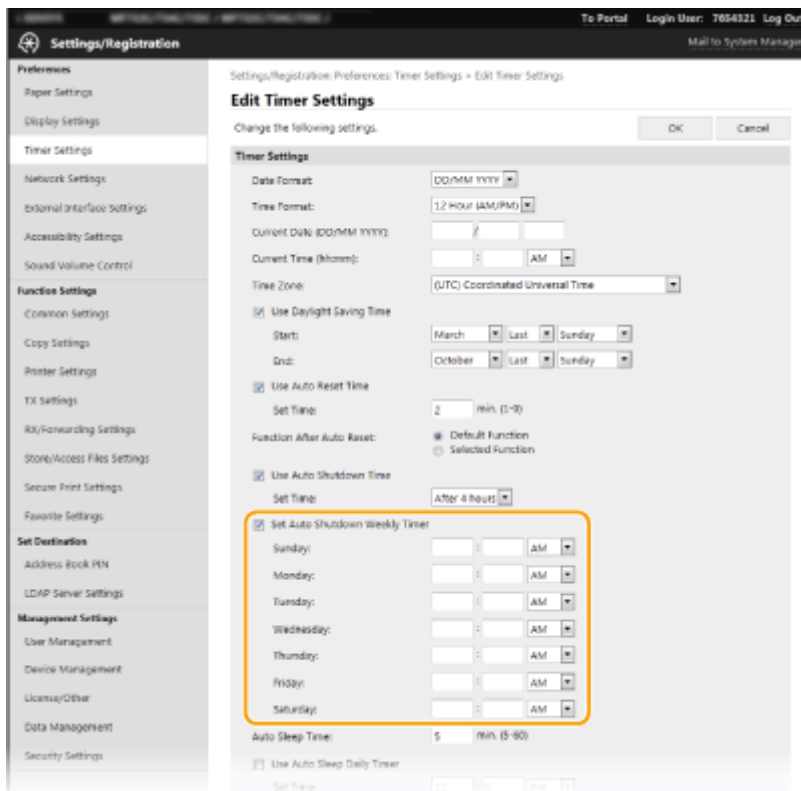

#### [Set Auto Shutdown Weekly Timer]

Selecting the check box allows you to set the time to turn OFF the power on each day of the week.

[Sunday] to [Saturday]

Enter the desired time to turn OFF the power. For any day of the week, leaving the time field blank means that the auto shutdown function is disabled for that day.

**5** Click [OK].

## NOTE

### If the power is not turned OFF automatically at the specified time\*

- When the Data indicator is lit up or blinking
- When the menu screen or Check Counter screen is displayed
- When settings data is being imported/exported
- When the firmware is being updated

\*If the power cannot be turned OFF automatically at the specified time, a retry will be performed up to ten times at intervals of one minute. If the power cannot be turned OFF even after ten retries, auto shutdown will be impossible for that day.

## Using the Operation Panel

---

261J-02E

You can use the display and keys of the operation panel to configure machine settings or operate functions. This section describes basic usage of the display and keys.

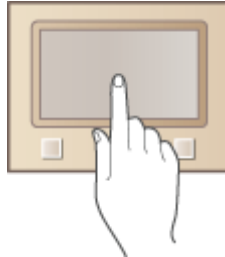

- ▶ **Basic Screens**(P. 120)
- ▶ **Basic Operation**(P. 127)
- ▶ **Entering Text**(P. 130)

### TIPS

- If you want to invert the light and dark parts of the display: ▶ **<Invert Screen Colors>**(P. 472)
- If you want to adjust the brightness of the display: ▶ **<Brightness>**(P. 472)

### LINKS

---

- ▶ **Operation Panel**(P. 113)

## Basic Screens

261J-02F

The Home screen or settings screen appears on the display, allowing you to initiate functions such as copy and scan. You can also use the display to check information such as error messages and the machine's operation status. The screen is also a touch panel, so you can perform operations by touching the screen directly.

- ▶ **Home Screen(P. 121)**
- ▶ **<Status Monitor> Screen(P. 124)**
- ▶ **Message Display(P. 126)**

### NOTE

- You can customize the Home screen by rearranging frequently used buttons for easier access to the respective functions. ▶ **Customizing the Display(P. 164)**

### To Know How to Operate

- On some screens, the <?> button allows you to view the descriptions of functions or how to operate.

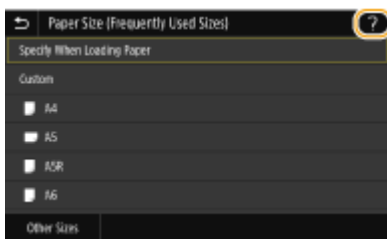



# Home Screen

261J-02H

The Home screen is displayed when the power is turned ON or by pressing  on the operation panel. Use this screen to specify settings for and register functions.



## 1 Change page

Use this to view another page in the Home screen. You can also flick sideways to change pages.

## 2 <Check Counter>

Displays the total volume of printouts. ▶ **Viewing the Counter Value(P. 580)**

## 3 <Log Out>

Use this button to log out from the machine.

## 4 <Status Monitor>

Press to check the printing status, to view the usage history, or to view the network settings such as the IP address of the machine. You can also check the status of the machine, such as the remaining amount of paper and the amount remaining in the toner cartridges, or whether any errors that occurred. ▶ **<Status Monitor> Screen(P. 124)**

## 5 Wi-Fi icon

Displayed when the machine is connected to a wireless LAN.

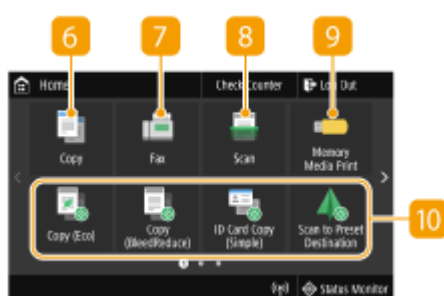

## 6 <Copy>

Use this button to start copying. ▶ **Copying(P. 187)**

## 7 <Fax>

Use this button to send a fax from the machine. ▶ **Faxing(P. 210)**

## 8 <Scan>

Scans an original and converts it into an electronic file. You can save scanned files on your computer or send them via e-mail. ▶ **Scanning(P. 274)**

## 9 <Memory Media Print>

Prints files stored in a USB memory device. ▶ **Printing from a USB Memory Device (Memory Media Print)(P. 265)**

**10 Application Library button**

You can use these buttons to perform convenient functions by a one-touch operation. For more information, see the manual for Application Library on the online manual website.

**11 <Secure Print>**

Use this function to print a secure document. ▶ **Printing a Document Secured by a PIN (Secure Print)(P. 261)**

**12 <Menu>**

<Function Settings>, <Preferences>, and many other machine settings start from this button. ▶ **Setting Menu List(P. 445)**

**13 <Address Book>**

Use this to register or edit the destinations for e-mails and faxes. You can also display a registered destination when sending an e-mail or fax. ▶ **Registering Destinations(P. 176)**

**14 <Paper Settings>**

This button is used for specifying the size and type of paper loaded in the paper drawer and multi-purpose tray. ▶ **Specifying Paper Size and Type(P. 154)**

**15 <Mobile Portal>**

Use this to establish a connection to a mobile device. ▶ **Connecting with Mobile Devices(P. 320)**

**16 <Home Screen Settings>**

Allows you to change the order that Home screen buttons are displayed in. ▶ **Customizing the Home Screen(P. 165)**

**17 <Update Firmware>**

Allows you to update the firmware via the Internet. ▶ **Updating the Firmware(P. 440)**

**18 <ID Card Copy>**

Use this function to copy the front and back sides of a driver's license or other card onto the same side of one sheet of paper. ▶ **Making ID Card Copies(P. 206)**

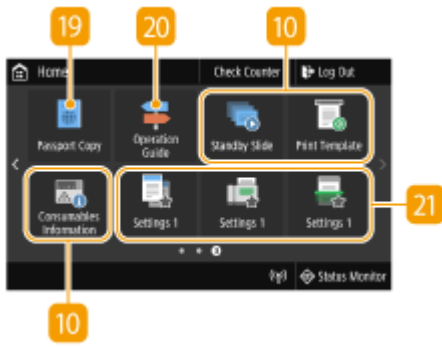

**19 <Passport Copy>**

Allows you to copy multiple passports onto one sheet. ▶  
**Making Passport Copies(P. 207)**

**20 <Operation Guide>**

Press to view operation guidance and error causes/solutions.

**21 Shortcut buttons**

Display "Favorite Settings" that are registered to Copy, Fax, and Scan. ▶  
**Adding Buttons to the Home Screen(P. 165)**

LINKS

---

▶**Customizing the Home Screen(P. 165)**

## <Status Monitor> Screen

261J-02J

When you select <Status Monitor>, a screen appears in which you can check the progress of document processing as well as the status of the machine (the amount of toner remaining in the toner cartridges, etc.) and network settings such as the machine's IP address.



### 1 <Error Information/Notification>

Displays the details of any errors that occurred. ▶ **Countermeasures for Each Message(P. 618)**

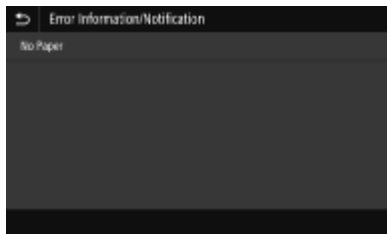

### 2 <Device Information>

Displays the status of the machine, such as the amount of paper or the amount of toner remaining in the toner cartridges.

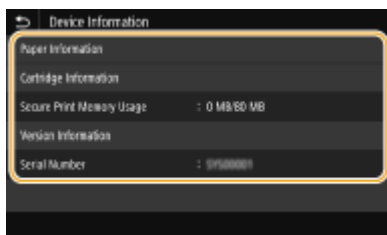

#### <Paper Information>

Displays whether paper is loaded in each paper source.

#### <Cartridge Information>

Displays the amount of toner remaining in the toner cartridges. Other internal parts may reach the end of their lifetime before the toner runs out.

#### <Secure Print Memory Usage>

Displays the amount of memory currently used for storing secured document data. ▶ **Printing a Document Secured by a PIN (Secure Print)(P. 261)**

#### <Version Information>

Displays firmware version information.

#### <Serial Number>

Displays the serial number of the machine.

**3 Status and logs of copied, printed, and sent/received documents**

Displays the current status of the selected item. The <Copy/Print Job> screen is shown below as an example.

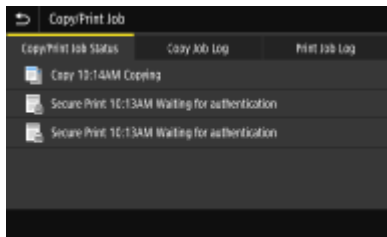

**4 <Network Information>**

Displays the network settings such as the IP address of the machine and status such as the condition of wireless LAN communications. ▶ **Viewing Network Settings(P. 38)**

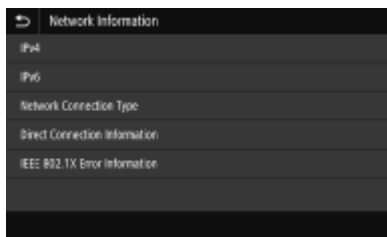

**5 <Rmv. Mem. Media>**

Used to safely remove a USB memory device. This is only displayed when a USB memory device is connected to the machine. ▶ **Remove the USB Memory Device(P. 184)**

## Message Display

261J-02K

Messages are displayed on the screen in situations such as when paper runs out or when the expiration of the toner cartridge lifetime is reached. **▶ Countermeasures for Each Message(P. 618)**



### When an Error Occurs

In some cases when an error occurs, instructions on how to respond to the error are displayed. Follow the on-screen instructions to solve the problem. The screen displayed when a paper jam occurs is shown below as an example.

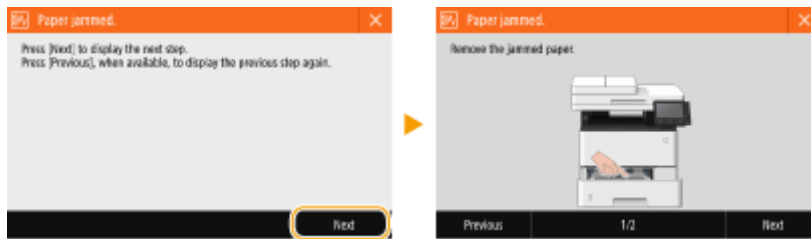

## Basic Operation

---

261J-02L

The display is a touch panel, allowing you to operate directly on the screen.

### IMPORTANT

#### Avoid the following actions.

- The display may malfunction or be damaged.
  - Pressing forcefully
  - Pressing with pointed objects (fingernails, ballpoint pen, pencil, etc.)
  - Operating with wet/soiled hands
  - Operating the display while an object is placed on it

### NOTE

- Before using the touch panel display, peel off the protective film from the display.

#### Tap

Touch the screen lightly and quickly. Use for selecting or finalizing items.



#### Flick

Flick with the finger on the display. The effect of flicking varies depending on the screen. For instance, flicking in the Home screen moves you one page in the direction of the flick.

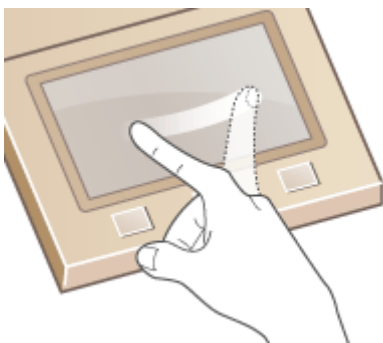

#### ■ Selecting Items

Tap an item name or button to make a selection.

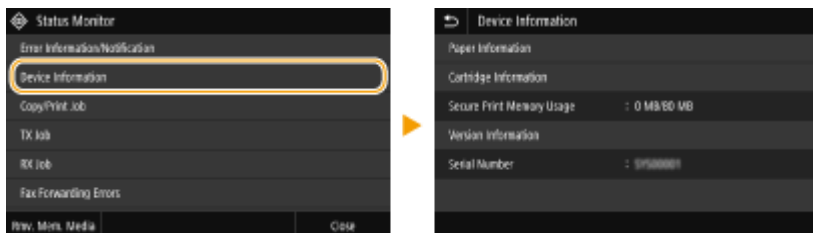

## NOTE

### If an item is mistakenly touched

- Slide your finger away then release it from the screen to cancel the selection.



### To return to the previous screen

- Tap  to return to the previous screen.

## ■ Scrolling the Screen

The scroll bar appears on the screen when there is still information that is undisplayed. If the scroll bar is displayed, flick the screen to scroll in the direction of the flick. Note that the scroll bar only appears while the screen is being touched.

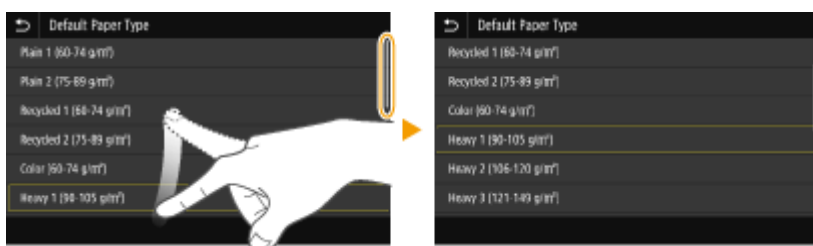

## ■ Changing the Setting Value

Tap <+>/<-> to adjust the setting on the scale. You can also adjust a setting by flicking the slider left or right.

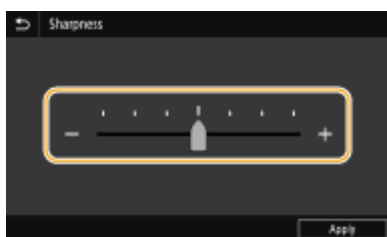

## TIPS



- You can change a variety of display-related settings, such as the display language: ▶<Display Settings>(P. 447)
- You can change the screen that is automatically displayed when the machine remains idle for a specified length of time: ▶<Function After Auto Reset>(P. 454)
- You can change various settings about the operability such as screen brightness: ▶<Accessibility>(P. 472)

## Entering Text

261J-02R

When entering text or a number, use the keyboard displayed on the screen. The numeric keys are displayed on the screen to enter only numbers.

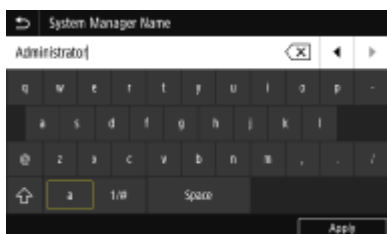

### Switching the Type of Character

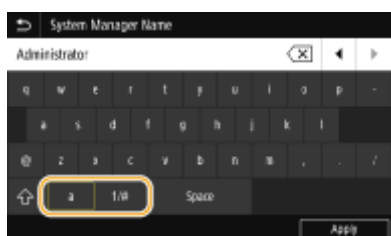

Tap <a> or <1/#> to switch the type of character that is entered.





## NOTE

- To enter upper case characters, tap .

### Deleting Text

One character is deleted each time  is tapped. Holding down  allows you to delete successive characters.

### Moving the Cursor (Entering a Space)

Tap  or  to move the cursor. To enter a space, move the cursor to the end of the text, and tap .

### When the Numeric Keys are Displayed

When you are supposed to enter only a numeric value, the numeric keys are displayed on the screen. Tap numeric keys to enter the numeric value.

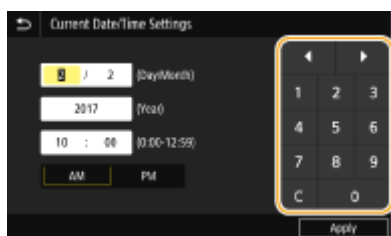



## NOTE



### Value range

- The values in ( ) displayed the entry box are the enterable value range.

**When buttons other than the numeric keys are displayed**

- When <+>/<-> or / are displayed, you can tap the buttons to increase or decrease the numeric value or move the cursor.

**Entering Characters Using a USB Keyboard**

You can connect a keyboard to the USB port for USB devices on the  **Front Side(P. 106)** or  **Back Side(P. 108)** and enter text from the keyboard. Even while the keyboard is connected, you can enter text from the operation panel.

**NOTE**

- Some keys on the USB keyboard, such as the [Backspace], [Home] and [End] keys, cannot be used. When keys that cannot be used are pressed, nothing is entered or changed.
- To delete text, press the [Delete] key.
- Pressing the [RETURN/ENTER] key completes text entry in the same way as selecting <Apply>.
- You can specify the type of keyboard layout (US layout or UK layout).  **<English Keyboard Layout>(P. 451)**
- You can disconnect the USB keyboard from the machine at any time. No special operation is required to disconnect it.
- Depending on the display language, you may not be able to enter some characters correctly.
- The USB keyboard may not operate correctly depending on its type.

# Logging in to the Machine

261J-02S

If Department ID Management is enabled or System Manager IDs are enabled, you must log in before using the machine. You also need to log in if use of the fax and scan functions is restricted.

▶ **Department ID Management Login(P. 132)**

▶ **Logging in to Authorized Send(P. 132)**

## Department ID Management Login

When the login screen appears, use the procedure below to enter the Department ID and PIN.

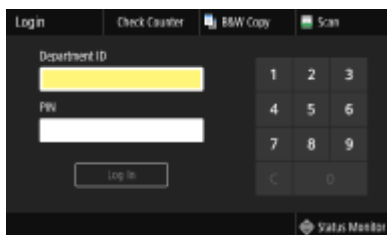

## NOTE

- When <Insert the card.> is displayed, see ▶ **Copy Card Reader-F(P. 688)** .

### 1 Enter the ID.

- 1 Select <Department ID> or <System Manager ID>.
- 2 Enter the ID.
  - If no PIN is registered, proceed to step 3.

### 2 Enter the PIN.

- 1 Select <PIN>.
- 2 Enter the PIN.

### 3 Select <Log In>.

- ⇒ The login screen will be changed to the Home screen.
  - After you finish using the machine, select <Log Out> to display the login screen.

## Logging in to Authorized Send

If the Send function authorization setting ( ▶ **LDAP Server Authentication(P. 359)** ) is enabled, the Authorized Send login screen appears when the fax or scan function is used.

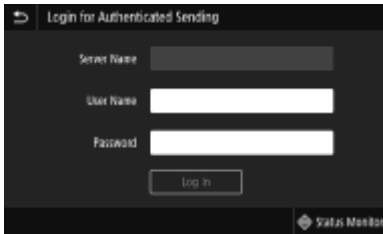

## 1 Enter your user name.

- 1 Select <User Name>.
- 2 Enter your user name.
  - On how to enter text, see [▶Entering Text\(P. 130\)](#) .

## 2 Enter the password.

- 1 Select <Password>.
- 2 Enter the password.

## 3 Select <Server Name>, and select the server for your authentication.

- Select the LDAP server where your user name and password are registered.

## 4 Select <Log In>.

- ⇒ The login screen switches to the fax or scan function Home screen.
  - After you finish using the machine, select <Log Out> to display the login screen.

### NOTE:

#### If the <Select Logout Type> screen appears

- If you are logged in to both Authorized Send and Department ID Management, a dialog box appears in which you can select the items you want to log out of. In the case where you want to log out of Authorized Send (fax or scan function) while remaining logged in to Department ID Management, select <Log Out from Authenticated Sending>. In any other cases, select <Log Out from All Authenticated Functions>.

### LINKS

---

- ▶[Setting the Department ID Management\(P. 351\)](#)
- ▶[Setting the System Manager ID and PIN\(P. 349\)](#)

## Placing Originals

Place originals on the platen glass or in the feeder. Use the platen glass when scanning thick or bound documents such as books. You can load two or more sheets of originals in the feeder so that they can be scanned continuously. For information on loadable sizes, etc., see [▶Main Unit\(P. 669\)](#) or [▶Feeder\(P. 672\)](#) .



[▶Placing Originals on the Platen Glass\(P. 135\)](#)

[▶Placing Originals in the Feeder\(P. 135\)](#)

### IMPORTANT

#### Use originals that are completely dry

- When placing originals, make sure that any glue, ink, or correction fluid on the originals has completely dried.

#### To avoid paper jams

- Do not place the following types of originals in the feeder as this may cause paper jams:
  - Wrinkled or creased paper
  - Carbon paper
  - Curled or rolled paper
  - Coated paper
  - Torn paper
  - Onion skin or thin paper
  - Stapled or clipped originals
  - Paper printed by a thermal transfer printer
  - Transparencies



### NOTE

#### To scan originals more accurately

- Originals placed in the feeder are scanned while being fed into the machine. On the other hand, originals placed on the platen glass remain in a fixed position while they are scanned. To ensure more accurate scanning results, placing originals on the platen glass is recommended.

#### To scan tracing paper or transparencies

- To scan transparent originals (for example, tracing paper or transparencies), place them on the platen glass.

## Placing Originals on the Platen Glass

### 1 Open the feeder.

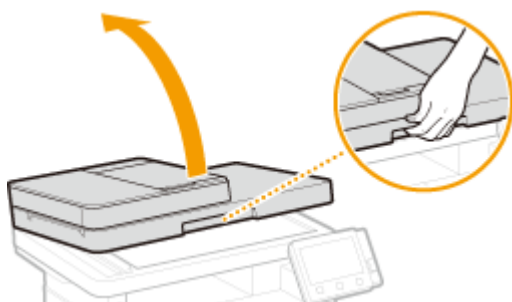

### 2 Place the original face down on the platen glass.

- Align the corner of the original with the top-left corner of the platen glass.



#### NOTE:

- To scan transparent originals (for example, tracing paper or transparencies), cover them with plain white paper.

### 3 Gently close the feeder.

⇒ The machine is ready to scan the document.

#### NOTE:

##### When scanning is complete

- Remove the original from the platen glass.

## Placing Originals in the Feeder

### 1 Open the original supply tray.



## 2 Spread the slide guides apart.

- Slide the slide guides outward until they are slightly farther apart than the actual original width.

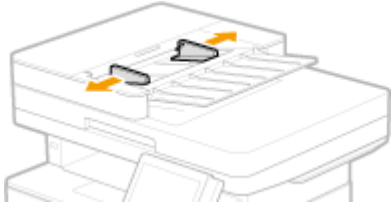

## 3 Fan the original stack and align the edges.

- Fan the original stack in small batches, and align the edges by lightly tapping the stack on a flat surface a few times.



## 4 Place the original(s) face up in the feeder.

- Place the original(s) in the landscape orientation.
- Make sure that the original stack does not exceed the load limit line (a).



### IMPORTANT:

- Do not load originals of various sizes at the same time.
- If originals are loaded so that they exceed the load limit line, scanning may stop or a paper jam may occur.

## 5 Align the slide guides against the edges of the original.

- Slide the slide guides inward until they are aligned securely against the edges of the original.



⇒ The machine is ready to scan the original.



## **IMPORTANT:**

### **Align the slide guides securely against the edges of the original**

- Slide guides that are too loose or too tight can cause misfeeds or paper jam.

### **While originals are being scanned**

- Do not add or remove originals.

### **When scanning is complete**

- Remove the scanned originals from beneath the feeder to prevent paper jams.

# Loading Paper

261J-02W

You can load the paper into the paper drawer or multi-purpose tray. Load the paper you usually use into the paper drawer. The paper drawer is convenient when using large amounts of paper. Use the multi-purpose tray when you temporarily use a size or type of paper that is not loaded in the paper drawer. See [▶ Available Paper\(P. 673\)](#) for available paper sizes and types.

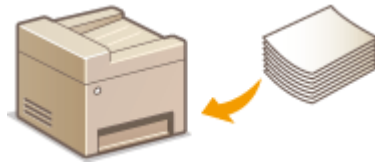

## About Paper

- ▶ [Precautions for Paper\(P. 138\)](#)
- ▶ [Storing the Paper Printed with the Machine\(P. 139\)](#)

## How to Load Paper

- ▶ [Loading Paper in the Paper Drawer\(P. 140\)](#)
- ▶ [Loading Paper in the Multi-Purpose Tray\(P. 145\)](#)
- ▶ [Loading Envelopes\(P. 148\)](#)
- ▶ [Loading Preprinted Paper\(P. 150\)](#)

## Configuring the Settings for the Loaded Paper

- ▶ [Specifying Paper Size and Type\(P. 154\)](#)

## Precautions for Paper

### IMPORTANT

#### Do not use the following types of paper:

- A paper jam or printing error may occur.
  - Wrinkled or creased paper
  - Curled or rolled paper
  - Torn paper
  - Damp paper
  - Very thin paper
  - Thin coarse paper
  - Paper printed by a thermal transfer printer
  - Back side of paper printed by a thermal transfer printer
  - Highly textured paper
  - Glossy paper

#### Notes on use of paper

- Only use paper that has fully acclimatized to the environment in which the machine is installed. Using paper that has been stored under different temperature or humidity conditions may cause paper jams or result in poor print quality.

### Paper handling and storage

- It is recommended that you use paper as soon as possible after unwrapping. Paper remaining unused should be covered with the original wrapping paper and stored on a flat surface.
- Keep the paper wrapped in its original package to protect the paper from moisture or dryness.
- Do not store the paper in such a way that may cause it to curl or fold.
- Do not store the paper vertically or do not stack too much paper.
- Do not store the paper in direct sunlight, or in a place subject to high humidity, dryness, or drastic changes in temperature or humidity.

## NOTE

### When printing on paper that has absorbed moisture

- Steam may emit from the paper output area, or water droplets may form around the paper output area. There is nothing unusual about any of these occurrences, which occur when the heat generated from fixing toner on the paper causes moisture in the paper to evaporate (most likely to occur at low room temperatures).

## Storing the Paper Printed with the Machine

When handling/storing the paper printed with the machine, take the following precautions.

### ■ How to Store the Printed Paper

- Store on a flat surface.
- Do not store together with articles made of PVC (polyvinyl chloride) such as clear folders. Toner may melt, resulting in the paper's sticking to PVC articles.
- Take care that the paper does not get folded or creased. Toner may peel off.
- To store over a long period of time (two years or longer), store in binders or equivalent.
- When the paper is stored over a long period of time, it may become discolored and thus the print may seem to have undergone a change of color.
- Do not store in a place where the temperature is high.

### ■ Precautions When Applying Adhesive

- Always use insoluble adhesive.
- Before applying adhesive, perform a test using a printout no longer required.
- When putting adhesive-applied paper sheets one over another, make sure that the adhesive is completely dried out.

## LINKS

---

- [Registering a Custom Paper Size\(P. 161\)](#)

## Loading Paper in the Paper Drawer

Load the paper that you usually use in the paper drawer. When you want to print on paper that is not loaded in the paper drawer, load the paper in the multi-purpose tray. **▶Loading Paper in the Multi-Purpose Tray(P. 145)**

**▶Loading Regular Size Paper(P. 140)**

**▶Loading Custom Size Paper(P. 142)**

### IMPORTANT

- When using A5 size paper, see **▶Loading Regular Size Paper(P. 140)** and load it in the landscape orientation. When loading paper in the portrait orientation, follow the steps shown in **▶Loading Custom Size Paper(P. 142)** .
- When using A6 size paper, see **▶Loading Custom Size Paper(P. 142)** and load it in the portrait orientation.

Landscape orientation

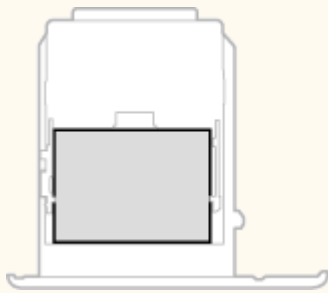

Portrait orientation

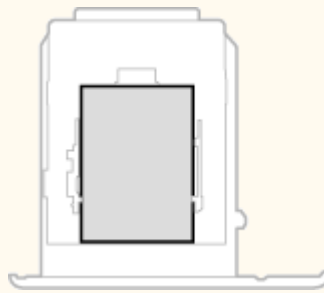

### NOTE

- Follow the procedure below when loading paper into the optional paper feeder.

### Loading Regular Size Paper

To load paper whose size is found in the paper size markings on the paper drawer, use the following procedure. For paper whose size is not found in the paper size markings, see **▶Loading Custom Size Paper(P. 142)** .

- 1 Pull out the paper drawer until it stops, and remove it while lifting the front side.**

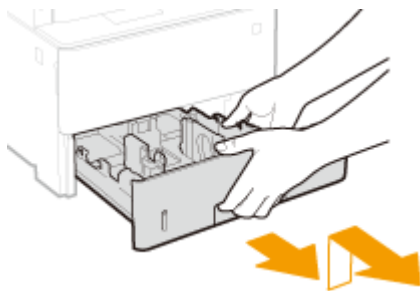

- 2 Adjust the positions of the paper guides to the paper size you want to use.**

- While pressing the lock release lever, move the paper guide to align the projection to the appropriate paper size marking.

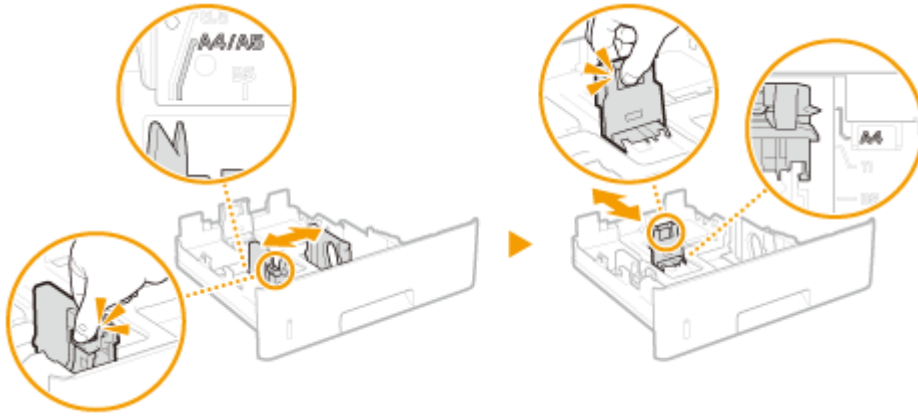

**NOTE:**

**When loading Legal size paper**

- Press the lock release lever, and extend the paper drawer.

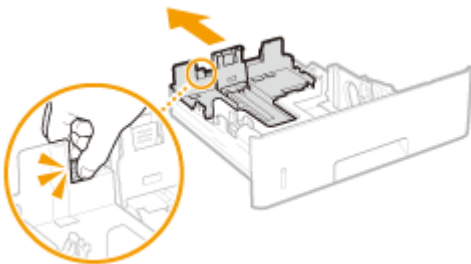

**3 Load the paper so that the edge of the paper stack is aligned against the paper guide on the rear side of the paper drawer.**

- Load the paper with the print side face down.
- Fan the paper stack well, and tap it on a flat surface to align the edges of the paper stack.

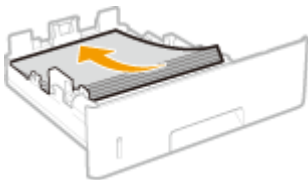

**IMPORTANT:**

**Do not exceed the load limit line when loading paper**

- Make sure that the paper stack does not exceed the load limit line (a). Loading too much paper can cause paper jams.

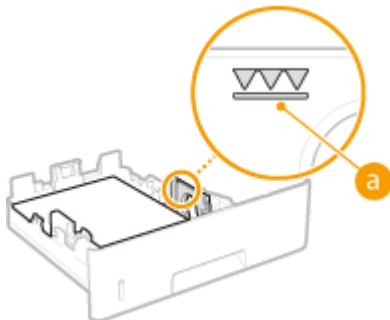

**NOTE:**

- When loading paper with a logo, see **Loading Preprinted Paper(P. 150)** .

## 4 Insert the paper drawer into the machine.

- When you insert the paper drawer with <Notify to Check Paper Settings> set to <On>, a confirmation screen is displayed. **▶<Notify to Check Paper Settings>(P. 548)**

### » Continue to **▶Specifying Paper Size and Type in the Paper Drawer(P. 155)**

#### IMPORTANT:

##### When changing the paper size or type

- The factory default settings for paper size and type are <A4> and <Plain 2>, respectively. If you load a different size or type of paper into the machine, make sure to change the settings. If you do not change the settings, the machine cannot print properly.

#### Printing on the Back Side of Printed Paper (Manual 2-Sided Printing)

- You can print on the back side of printed paper. Flatten any curls on the printed paper and insert it into the paper drawer with the print side face down or into the multi-purpose tray ( **▶Loading Paper in the Multi-Purpose Tray(P. 145)** ) with the print side face up.
  - When using the multi-purpose tray, load one sheet of paper each time you print.
  - You can use only the paper printed with this machine.
  - You cannot print on the side that has previously been printed on.
  - If the printouts look faded, set the target paper source to <On> in <Manual Back Side Print (2-Sided Only)>. **▶<Manual Back Side Print (2-Sided Only)>(P. 476)**
  - If you are using A5 size paper, the reverse side may not be printed correctly.

## Loading Custom Size Paper

To load custom size paper or other paper whose size is not found in the paper size markings on the paper drawer, use the following procedure.

### 1 Pull out the paper drawer until it stops, and remove it while lifting the front side.

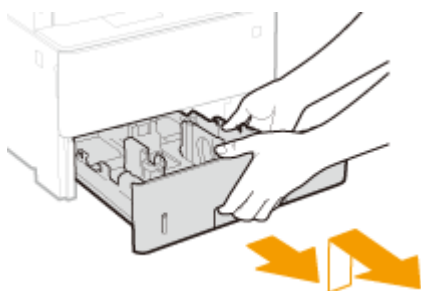

### 2 Spread the paper guides apart.

- Press the lock release lever to slide the paper guides outward.

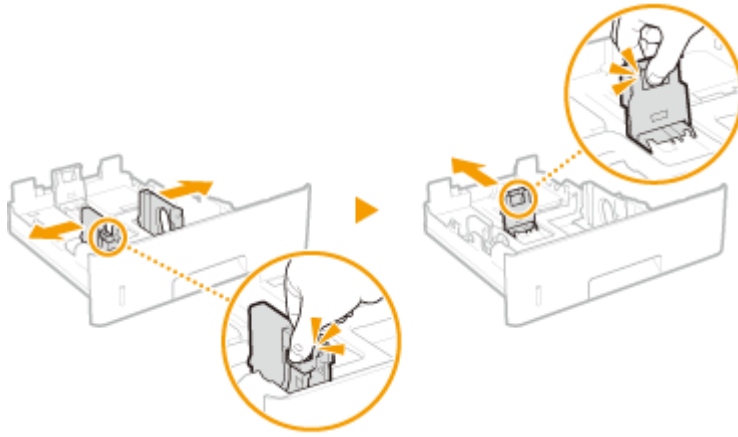

**NOTE:**

**When loading longer paper than A4 size**

- Press the lock release lever, and extend the paper drawer.

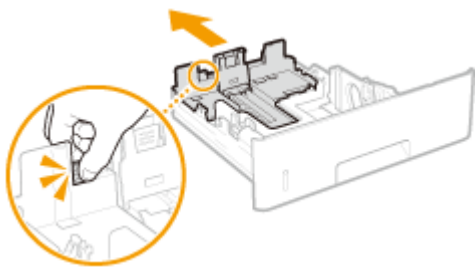

**3 Load the paper so that the edge of the paper stack is aligned against the front side of the paper drawer.**

- Load the paper with the print side face down.
- Fan the paper stack well, and tap it on a flat surface to align the edges of the paper stack.

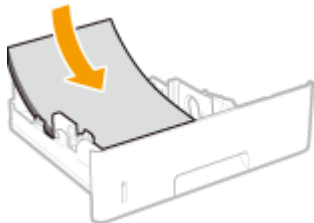

**IMPORTANT:**

**Do not exceed the load limit line when loading paper**

- Make sure that the paper stack does not exceed the load limit line (a). Loading too much paper can cause paper jams.

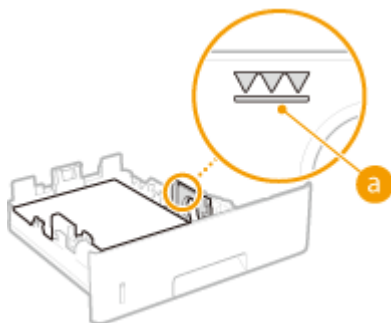

**NOTE:**

- When loading paper with a logo, see **Loading Preprinted Paper(P. 150)** .

## 4 Align the paper guides against the edges of the paper.

- Press the lock release lever and slide the paper guides inward until they are aligned securely against the edges of the paper.

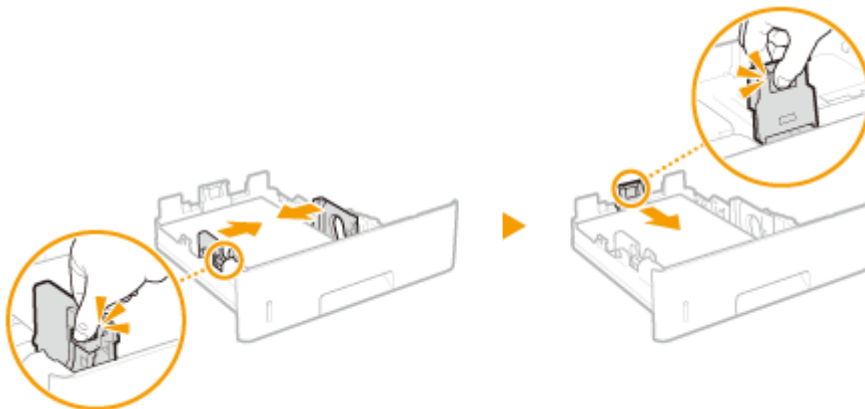

### IMPORTANT:

Align the paper guides securely against the edges of the paper

- Paper guides that are too loose or too tight can cause misfeeds or paper jams.

## 5 Insert the paper drawer into the machine.

- When you insert the paper drawer with <Notify to Check Paper Settings> set to <On>, a confirmation screen is displayed. [▶<Notify to Check Paper Settings>\(P. 548\)](#)

» Continue to [▶Specifying Paper Size and Type in the Paper Drawer\(P. 155\)](#)

### IMPORTANT:

When changing the paper size or type

- The factory default settings for paper size and type are <A4> and <Plain 2>, respectively. If you load a different size or type of paper into the machine, make sure to change the settings. If you do not change the settings, the machine cannot print properly.

#### Printing on the Back Side of Printed Paper (Manual 2-Sided Printing)

- You can print on the back side of printed paper. Flatten any curls on the printed paper and insert it into the paper drawer with the print side face down or into the multi-purpose tray ( [▶Loading Paper in the Multi-Purpose Tray\(P. 145\)](#) ) with the print side face up.
  - When using the multi-purpose tray, load one sheet of paper each time you print.
  - You can use only the paper printed with this machine.
  - You cannot print on the side that has previously been printed on.
  - If the printouts look faded, set the target paper source to <On> in <Manual Back Side Print (2-Sided Only)>. [▶<Manual Back Side Print \(2-Sided Only\)>\(P. 476\)](#)
  - If you are using A5 size paper, the reverse side may not be printed correctly.

#### LINKS

[▶Available Paper\(P. 673\)](#)



# Loading Paper in the Multi-Purpose Tray

261J-02Y

When you want to print on paper that is not loaded in the paper drawer, load the paper in the multi-purpose tray. Load the paper that you usually use in the paper drawer. **▶ Loading Paper in the Paper Drawer (P. 140)**

## IMPORTANT

### Make sure to insert the paper drawer

- The machine only prints when the paper drawer is inserted, even if paper is loaded in the multi-purpose tray. An error message is displayed if you attempt to print without inserting the paper drawer.

## NOTE

### When loading A5/A6 size paper

- When setting the paper size, make sure the current paper orientation. **▶ Specifying Paper Size and Type in the Multi-Purpose Tray (P. 157)**
- When using A6 size paper, load it in the portrait orientation.

#### Landscape orientation

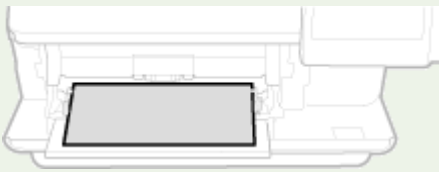

#### Portrait orientation

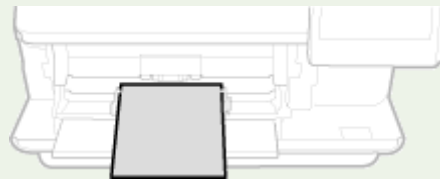

## 1 Open the cover.

- Hold the left and right side handles, and open the cover.

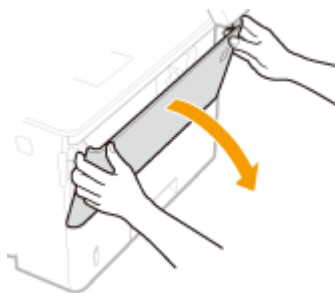

## 2 Pull out the paper tray and the tray extension.

- Pull out the tray extension when loading large paper.

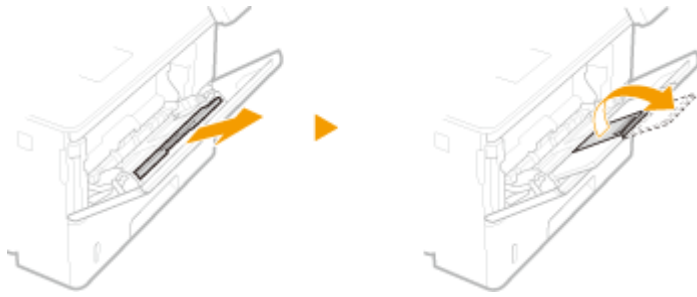

### 3 Spread the paper guides apart.

- Press the lock release lever to slide the paper guides outward.

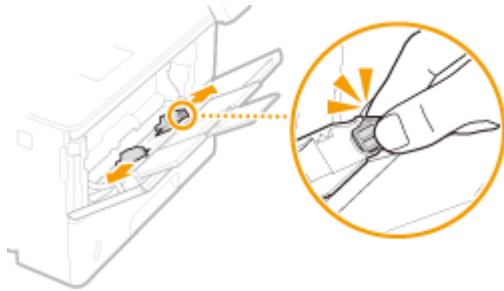

### 4 Insert the paper into the multi-purpose tray until the paper stops.

- Load the paper with the print side face up.
- Fan the paper stack well, and tap it on a flat surface to align the edges of the paper stack.

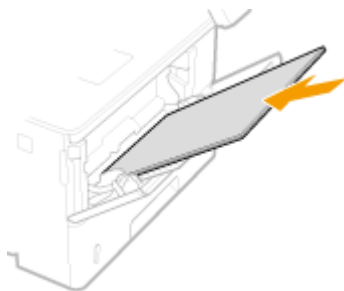

### IMPORTANT:

Do not exceed the load limit guide when loading paper

- Make sure that the paper stack does not exceed the load limit guide (a). Loading too much paper can cause paper jams.

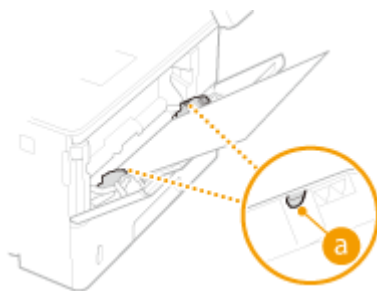

### NOTE:

- When loading envelopes or paper with a logo, see ▶Loading Envelopes(P. 148) or ▶Loading Preprinted Paper(P. 150) .

## 5 Align the paper guides against the edges of the paper.

- Press the lock release lever and slide the paper guides inward until they are aligned securely against the edges of the paper.

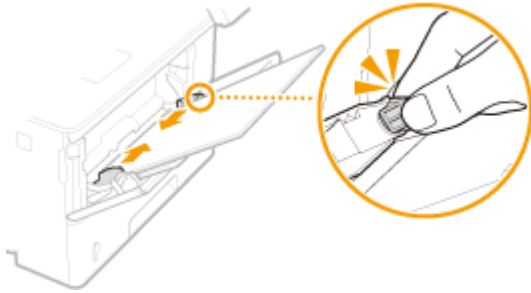

### IMPORTANT:

Align the paper guides securely against the edges of the paper

- Paper guides that are too loose or too tight can cause misfeeds or paper jams.

» Continue to **▶ Specifying Paper Size and Type in the Multi-Purpose Tray(P. 157)**

#### Printing on the Back Side of Printed Paper (Manual 2-Sided Printing)

- You can print on the back side of printed paper. Flatten any curls on the printed paper and insert it into the paper drawer ( **▶ Loading Paper in the Paper Drawer(P. 140)** ) with the print side face down or into the multi-purpose tray with the print side face up.
  - When using the multi-purpose tray, load one sheet of paper each time you print.
  - You can use only the paper printed with this machine.
  - You cannot print on the side that has previously been printed on.
  - If the printouts look faded, set the target paper source to <On> in <Manual Back Side Print (2-Sided Only)>. **▶ <Manual Back Side Print (2-Sided Only)>(P. 476)**
  - If you are using A5 size paper, the reverse side may not be printed correctly.

#### LINKS

**▶ Available Paper(P. 673)**

# Loading Envelopes

261J-030

Make sure to flatten any curls on envelopes before loading them. Also pay attention to the orientation of envelopes and which side is face up. You cannot load envelopes in the paper drawer.

🔴 **Before Loading Envelopes(P. 148)**

🔴 **In the Multi-Purpose Tray(P. 149)**

## NOTE

- This section describes how to load envelopes in the orientation you want, as well as procedures that you need to complete before loading envelopes. For a description of the general procedure for loading envelopes in the multi-purpose tray, see 🔴 **Loading Paper in the Multi-Purpose Tray(P. 145)** .

## Before Loading Envelopes

Follow the procedure below to prepare the envelopes before loading.

### 1 Close the flap of each envelope.

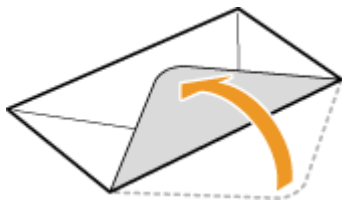

### 2 Flatten them to release any remaining air, and make sure that the edges are pressed tightly.



### 3 Loosen any stiff corners of the envelopes and flatten any curls.

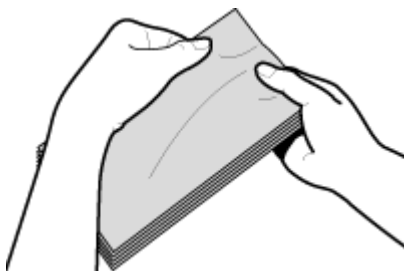

### 4 Align the edges of the envelopes on a flat surface.

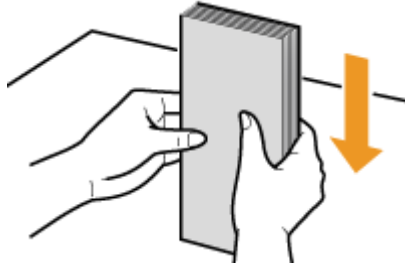

## In the Multi-Purpose Tray

Load the envelopes Monarch, COM10, DL, or ISO-C5 in portrait orientation (with the short edge toward the machine), with the non-glued side (front side) face up. You cannot print on the reverse side of envelopes.

### NOTE

- Load the envelopes so that the edge with the flap is toward the left side as shown in the illustration.

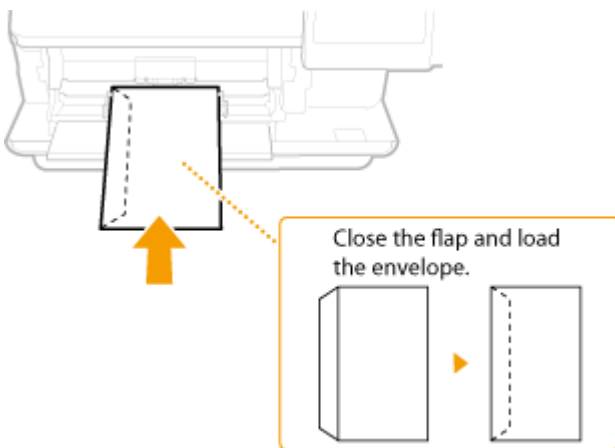

## Loading Preprinted Paper

261J-031

When you use paper that has been preprinted with a logo, pay attention to the orientation of the paper when loading. Load the paper properly so that printing is performed on the correct side of the paper with a logo.



▶ **Making 1-Sided Printouts on Paper with Logos(P. 150)**

▶ **Making 2-Sided Printouts on Paper with Logos(P. 152)**

### NOTE

- This section mainly describes how to load preprinted paper with the proper facing and orientation. For a description of the general procedure for loading paper in the paper drawer or multi-purpose tray, see ▶ **Loading Paper in the Paper Drawer(P. 140)** or ▶ **Loading Paper in the Multi-Purpose Tray(P. 145)** .

## Making 1-Sided Printouts on Paper with Logos

### Printing on Paper with Logos in Portrait Orientation



### When loading paper in the paper drawer

Load the paper with the logo side (the side to print the document) face down.

Loading Orientation

Portrait



Landscape (A5)

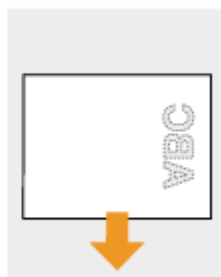

### When loading paper in the multi-purpose tray

Load the paper with the logo side (the side to print the document) face up.

Loading Orientation

Portrait

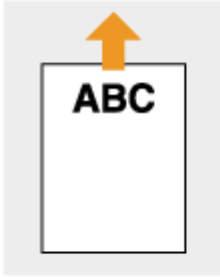

Landscape (A5)

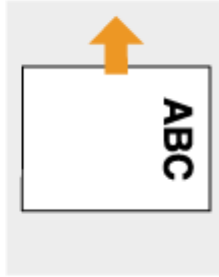

**Printing on Paper with Logos in Landscape Orientation**

Preprinted Paper

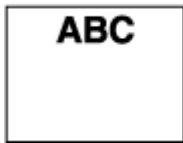

+

Document



→

Print Result



**When loading paper in the paper drawer**

Load the paper with the logo side (the side to print the document) face down.

Loading Orientation

Portrait



Landscape (A5)



**When loading paper in the multi-purpose tray**

Load the paper with the logo side (the side to print the document) face up.

Loading Orientation

Portrait

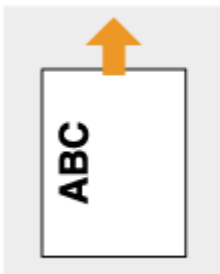

Landscape (A5)

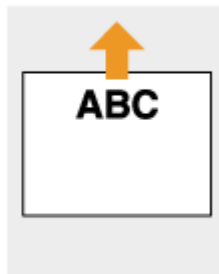

## Making 2-Sided Printouts on Paper with Logos

### Printing on Paper with Logos in Portrait Orientation

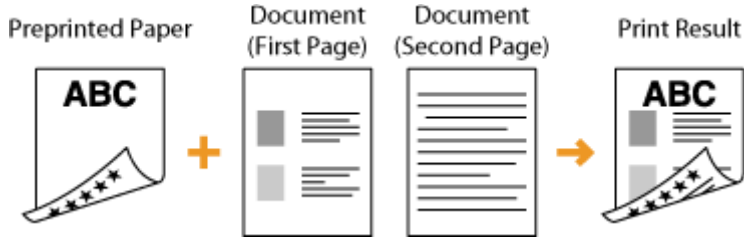

### When loading paper in the paper drawer

Load the paper with the front logo side (the side to print the first page of the document) face up.

Loading Orientation

Portrait



Landscape (A5)

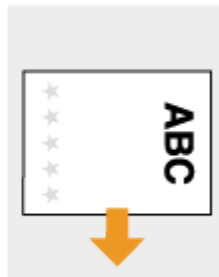

### When loading paper in the multi-purpose tray

Load the paper with the front logo side (the side to print the first page of the document) face down.

Loading Orientation

Portrait



Landscape (A5)





## Printing on Paper with Logos in Landscape Orientation



### When loading paper in the paper drawer

Load the paper with the front logo side (the side to print the first page of the document) face up.

Loading Orientation

Portrait



Landscape (A5)



### When loading paper in the multi-purpose tray

Load the paper with the front logo side (the side to print the first page of the document) face down.

Loading Orientation

Portrait



Landscape (A5)



## NOTE

### The <Switch Paper Feed Method> setting

- When you print on preprinted paper, you need to change the facing of the paper to load each time you perform 1-sided and 2-sided printing. However, if <Switch Paper Feed Method> is set to <Print Side Priority>, the facing that you use for loading preprinted paper for 2-sided printing (logo side face down) can also be used for 1-sided printing. This setting is especially useful if you frequently perform both 1-sided and 2-sided printing. <Switch Paper Feed Method>(P. 486)

## Specifying Paper Size and Type

---

261J-032

You must specify the paper size and type settings to match the paper that is loaded. Make sure to change the paper settings when you load the paper that is different from the previously loaded paper.

- ▶ **Specifying Paper Size and Type in the Paper Drawer(P. 155)**
- ▶ **Specifying Paper Size and Type in the Multi-Purpose Tray(P. 157)**
- ▶ **Registering Default Paper Settings for the Multi-Purpose Tray(P. 159)**
- ▶ **Registering a Custom Paper Size(P. 161)**
- ▶ **Limiting the Paper Sizes Displayed(P. 162)**
- ▶ **Automatically Selecting an Appropriate Paper Source for Each Function(P. 163)**

### IMPORTANT

- If the setting does not match the size and type of loaded paper, a paper jam or printing error may occur.

# Specifying Paper Size and Type in the Paper Drawer

261J-033

**1** Select <Paper Settings> in the Home screen.  Home Screen(P. 121)

**2** Select the target paper drawer.

- When the optional paper feeder is installed, its paper drawer is also displayed.

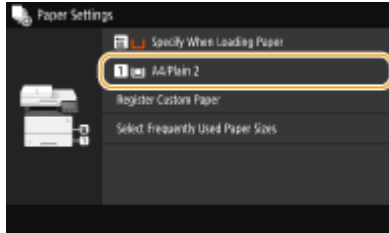

**3** Select the paper size.

- If the loaded paper size is not displayed, select <Other Sizes>.



## ■ When loading custom size paper

**1** Select <Custom>.

**2** Specify the length of the <X> side and <Y> side.

- Select <X> or <Y>, and enter the length of each side using the numeric keys.

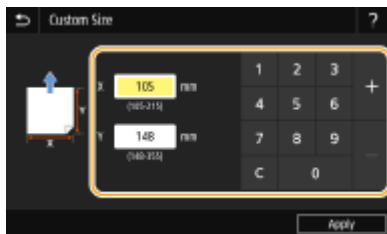

### NOTE:

- If you register the paper size you use frequently on buttons <S1> to <S3>, you can call them up with one touch.  Registering a Custom Paper Size(P. 161)

**3** Select <Apply>.

### NOTE:

When loading A5 size paper

- In the landscape orientation, select <A5>. In the portrait orientation, select <A5R>.

**Landscape orientation**

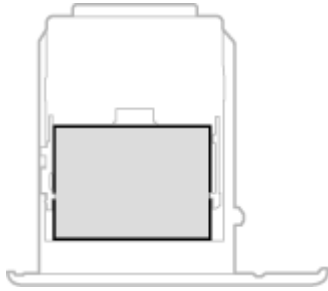

**Portrait orientation**

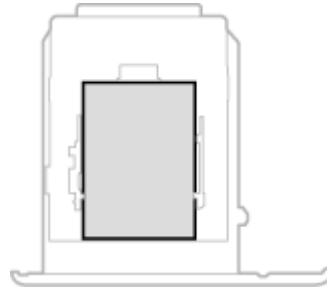

## 4 Select the paper type.

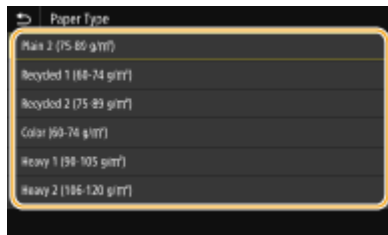

## LINKS

---

- ▶ [Loading Paper in the Paper Drawer\(P. 140\)](#)
- ▶ [Limiting the Paper Sizes Displayed\(P. 162\)](#)
- ▶ [Available Paper\(P. 673\)](#)
- ▶ [<Notify to Check Paper Settings>\(P. 548\)](#)

# Specifying Paper Size and Type in the Multi-Purpose Tray

261J-034

The screen shown here is displayed when paper is loaded in the multi-purpose tray. Follow the on-screen instructions to specify settings that match the size and type of the loaded paper.

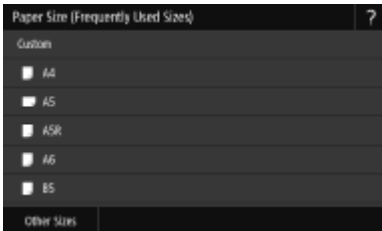

## NOTE

### If the screen shown above is not displayed when paper is loaded

- If you always load the same paper in the multi-purpose tray, you can skip the paper setting operations by registering the paper size and type as the default setting. When the default setting is registered, however, the screen shown above is not displayed. To display the screen, select <Specify When Loading Paper> (  **Registering Default Paper Settings for the Multi-Purpose Tray(P. 159)** ).

## 1 Select the paper size.

- If the loaded paper size is not displayed, select <Other Sizes>.

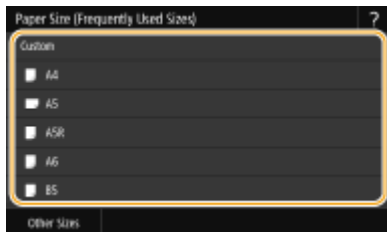

### ■When loading custom size paper

- Select <Custom>.
- Specify the length of the <X> side and <Y> side.
  - Select <X> or <Y>, and enter the length of each side using the numeric keys.



## NOTE:

- If you register the paper size you use frequently on buttons <S1> to <S3>, you can call them up with one touch.  **Registering a Custom Paper Size(P. 161)**

**3** Select <Apply>.

**2** Select the paper type.

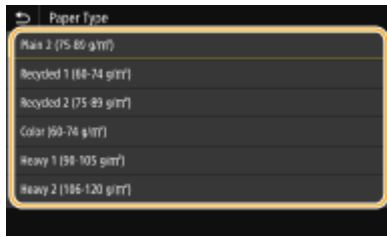

## LINKS

---

- ▶ **Loading Paper in the Multi-Purpose Tray(P. 145)**
- ▶ **Limiting the Paper Sizes Displayed(P. 162)**
- ▶ **Available Paper(P. 673)**

# Registering Default Paper Settings for the Multi-Purpose Tray

261J-035

You can register default paper settings for the multi-purpose tray. Registering default settings can save yourself the effort of having to specify the settings each time you load the same paper into the multi-purpose tray.

## NOTE

- After the default paper setting is registered, the paper setting screen is not displayed when paper is loaded, and the same setting is always used. If you load a different paper size or type without changing the paper settings, the machine may not print properly. To avoid this problem, select <Specify When Loading Paper> in step 3, and then load the paper.

**1** Select <Paper Settings> in the Home screen.  Home Screen(P. 121)

**2** Select multi-purpose tray.

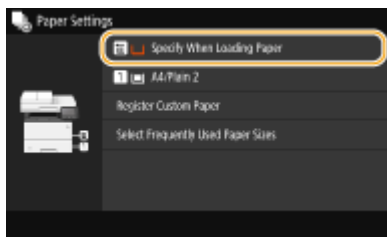

**3** Select the paper size.

- If the loaded paper size is not displayed, select <Other Sizes>.

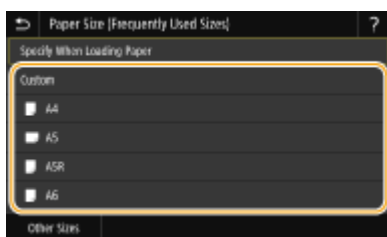

### ■ Registering a custom paper size

**1** Select <Custom>.

**2** Specify the length of the <X> side and <Y> side.

- Select <X> or <Y>, and enter the length of each side using the numeric keys.



## NOTE:

- If you register the paper size you use frequently on buttons <S1> to <S3>, you can call them up with one touch. ▶ **Registering a Custom Paper Size(P. 161)**

**3** Select <Apply>.

**4** Select the paper type.

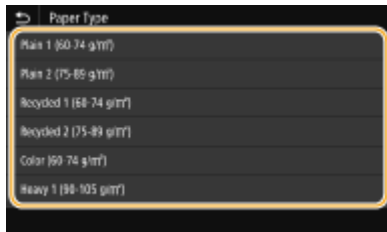

## LINKS

---

- ▶ **Loading Paper in the Multi-Purpose Tray(P. 145)**
- ▶ **Limiting the Paper Sizes Displayed(P. 162)**
- ▶ **Available Paper(P. 673)**



## Registering a Custom Paper Size

261J-036

You can register up to three frequently used custom paper sizes.

**1** Select <Paper Settings> in the Home screen. ▶ Home Screen(P. 121)

**2** Select <Register Custom Paper>.

**3** Select the registration number.

### NOTE:

#### Deleting a setting

- Select <Delete> ▶ <Yes>.

**4** Specify the length of the <X> side and <Y> side.

- Select <X> or <Y>, and enter the length of each side using the numeric keys.



**5** Select <Apply>.

### Setting to the registered custom size

The paper sizes that are registered in the procedure above can be called when <Custom> is selected on the paper size selection screen for the paper drawer or multi-purpose tray.



### LINKS

- ▶ Loading Paper in the Paper Drawer(P. 140)
- ▶ Loading Paper in the Multi-Purpose Tray(P. 145)

## Limiting the Paper Sizes Displayed

261J-037

You can ensure that only frequently used paper sizes are shown in the screen for selecting the paper size setting.

- 1** Select <Paper Settings> in the Home screen. [▶Home Screen\(P. 121\)](#)
- 2** Select <Select Frequently Used Paper Sizes>.
- 3** Select the paper source you want to limit the paper sizes to be displayed for.
  - When the optional paper feeder is installed, its paper drawer is also displayed.

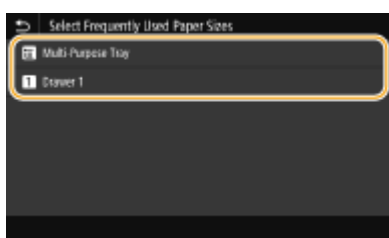

- 4** Clear the check boxes for paper sizes you do not want displayed.
  - Ensure that only the check boxes for frequently used paper sizes are selected.

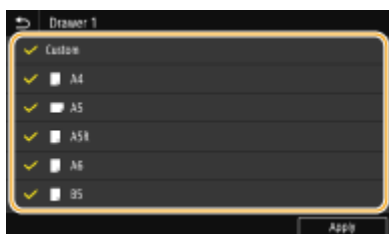

### NOTE:

- Paper sizes that are not selected can be viewed by selecting <Other Sizes> in the paper size setting selection screen.

- 5** Select <Apply>.

### LINKS

- [▶Specifying Paper Size and Type in the Paper Drawer\(P. 155\)](#)
- [▶Specifying Paper Size and Type in the Multi-Purpose Tray\(P. 157\)](#)
- [▶Registering Default Paper Settings for the Multi-Purpose Tray\(P. 159\)](#)

# Automatically Selecting an Appropriate Paper Source for Each Function

261J-038

Enable or disable the automatic paper source selection feature for each paper source. If this feature is set to <On>, the machine automatically selects a paper source that is loaded with paper of the appropriate size for each print job. Also, when the paper in the selected paper source runs out, this feature enables continuous printing by switching from that paper source to another that is loaded with the same paper size.

- 1 Select <Menu> in the Home screen. ▶ Home Screen(P. 121)
- 2 Select <Function Settings> ▶ <Common> ▶ <Paper Feed Settings>.
- 3 Select <Paper Source Auto Selection>.
- 4 Select the target function.

- When the target function is report/list printing or memory media print, select <Other>.



- 5 For each paper source to which you want to apply the automatic paper source selection feature, select <On>.

- When the optional paper feeder is installed, its paper drawer is also displayed.

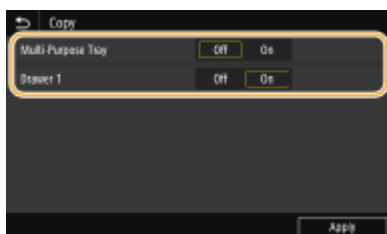

## NOTE:

- Always specify <On> for at least one of the paper drawers. If you select <Off> for all the drawers, then you cannot finish the setting procedure.

- 6 Select <Apply>.

## Customizing the Display

261J-039

In order to make the Home screen easier to use, you can customize it. In addition, you can work more efficiently by registering your favorite settings to the Basic Features screen for each function.



### Customizing the Home Screen

You can rearrange buttons that are displayed in the Home screen. In addition, you can customize the Home screen to make it easier to select functions by adding shortcut buttons. ▶ **Customizing the Home Screen(P. 165)**

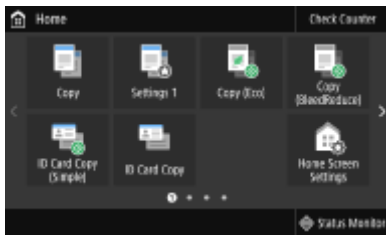

### Registering "Favorite Settings"

To make it possible to quickly call up the same settings for Copy, Fax, and Scan, you can register them as your favorite settings. You can add registered setting combinations to the Home screen as shortcut buttons. ▶ **Registering Frequently Used Settings(P. 168)**



# Customizing the Home Screen

You can add/delete shortcut buttons displayed in the Home screen according to your application or a preferred arrangement. You can also change the order that they are displayed in.

- ▶ **Adding Buttons to the Home Screen(P. 165)**
- ▶ **Changing the Arrangement of Buttons(P. 166)**

## Adding Buttons to the Home Screen

You can add shortcut buttons to the Home screen for frequently used functions such as <Copy>, <Fax>, and <Scan>. For example, you can carry out tasks more quickly and efficiently by assigning a sequence of settings (e.g. "Scan both sides of an original, save it as a highly compressed PDF file and send it via e-mail") to a single button.

### NOTE

- The settings to be added as a shortcut button must be registered beforehand as Favorite Settings. ▶ **Registering Frequently Used Settings(P. 168)**

#### 1 Select <Home Screen Settings> in the Home screen. ▶ **Home Screen(P. 121)**

- If the login screen appears, enter the correct ID and PIN. ▶ **Logging in to the Machine(P. 132)**

#### 2 Select <Select Button to Display>.

#### 3 Select the function with the Favorite Settings you want to add as a button.

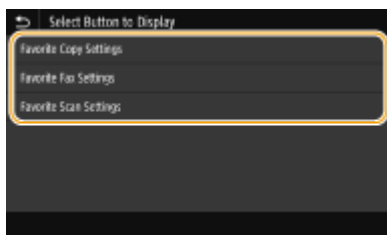

#### 4 Select the check box for all settings to be displayed in the Home screen and select <Apply>.

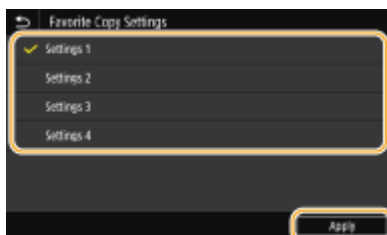

### NOTE:

Removing registered buttons

- Clear the check box for the name of the button you want to remove and then select <Apply>. Once you remove a registered button, a space appears where the button was displayed in the Home screen. If necessary, delete the space.

## 5 Read the message that is displayed, and select <OK>.

⇒ A button for the newly selected settings is added to the Home screen.

### NOTE:

- If the Home screen is full and no more settings can be registered, delete registered buttons and spaces in <Home Screen Settings>.

## Changing the Arrangement of Buttons

To make the buttons easier to use, you can rearrange the buttons however you like. For instance, you can put the most frequently used functions first, or arrange the function buttons together with shortcut buttons for Favorite Settings. You can also insert a blank (space) instead of a button to make it easier to view the Home screen.

### 1 Select <Home Screen Settings> in the Home screen. ▶ Home Screen(P. 121)

- If the login screen appears, enter the correct ID and PIN. ▶ Logging in to the Machine(P. 132)

### 2 Select <Set Display Order>.

### 3 Select the button to move.

- The selected button is highlighted. Tap the selected button again to deselect it.

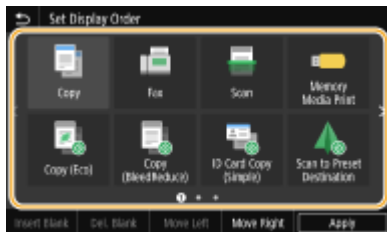

### 4 Select <Move Left> or <Move Right>.

- The button moves as many times as you tapped.
- A long touch on <Move Left> or <Move Right> moves the selected button continuously.

#### ■ Inserting a blank

- When <Insert Blank> is selected, a blank is inserted on the left side of the selected button.
- If the button at the end is selected, a blank is inserted even if <Move Right> is selected.

### NOTE:

#### Deleting a blank

- Select the blank to be deleted, and select <Del. Blank>.

## 5 Select <Apply>.

### LINKS

---

▶ Basic Operation(P. 127)

# Registering Frequently Used Settings

261J-03C

If you register your frequently used settings as "favorite settings," you can quickly call up the same settings every time you make copies, send a fax, or scan. In addition, if you register complicated settings as "favorite settings," you can quickly call them up for ease of operation. You can also assign registered setting combinations to a shortcut button displayed in the Home screen. This section describes how to register frequently used settings and how to call them up when making a copy.

▶ **Registering Settings(P. 168)**

▶ **Recalling Registered Settings(P. 169)**

## NOTE

- You can also register a fax or scan destination in the frequently used settings, however, it cannot be changed once it is registered. To change a registered destination, delete the settings and then register them again.

## Registering Settings

- 1 Select <Copy> in the Home screen. ▶ Home Screen(P. 121)**
- 2 Change the values for the settings you want to register. ▶ Basic Copy Operations(P. 191)**
- 3 Select <Other Settings> ▶ <Favorite Settings>.**
- 4 Select unregistered settings, and select <Register>.**

- To change the content of a registered setting, select that setting and select <Edit>.

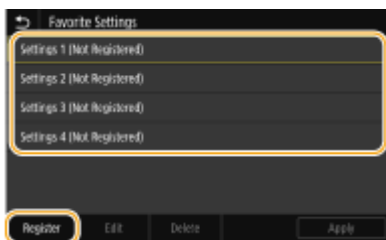

- 5 Check the details of the settings to be registered, and select <Register>.**

- To change the value of a setting to be registered, select the setting.
- To rename the setting, select <Name>. On how to enter text, see ▶ **Entering Text(P. 130)** .



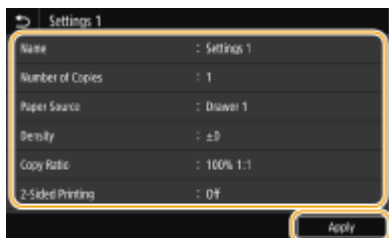

## 6 Select whether to register the settings as a shortcut button.

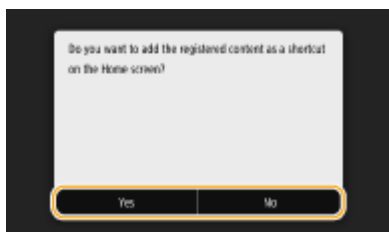

- If you select <Yes>, a message appears. Check the message and then select <OK>. The registered setting combination is added to the Home screen as a shortcut button.

### NOTE:

- If the Home screen is full and the shortcut button cannot be added, use <Home Screen Settings> to delete registered buttons or blanks. ▶ **Customizing the Home Screen(P. 165)**

## NOTE

- Registered settings are retained even when the machine is turned OFF.
- If you want to delete a registered setting, select <Copy> ▶ <Other Settings> ▶ <Favorite Settings> ▶ select the settings, and select <Delete> ▶ <Yes>.

## Recalling Registered Settings

Simply select the setting combination that suits your purpose from the favorite settings.



<Copy> ▶ <Other Settings> ▶ <Favorite Settings> ▶ Select the setting combination to be recalled, and select <Apply>

## NOTE

- Once you have recalled the setting combination, you can also change the copy settings as needed.

## LINKS

- ▶ **Basic Copy Operations(P. 191)**
- ▶ **Basic Operations for Sending Faxes(P. 214)**
- ▶ **Basic Operations for Scanning Originals(P. 279)**

## Changing the Default Settings for Functions

261J-03E

The default settings are the settings that are displayed whenever you turn ON the machine, or when you select <Reset>. If you change these default settings to match the operations that you perform frequently, you can eliminate the need to specify the same settings every time you perform an action.

### ■ Copy

For information about changeable setting items, see [▶<Change Default Settings \(Copy\)>\(P. 490\)](#) .



<Menu> ▶ <Function Settings> ▶ <Copy> ▶ <Change Default Settings (Copy)> ▶ Select the setting  
▶ Change the default value of the selected item ▶ <Apply> ▶

### ■ FAX

For information about changeable setting items, see [▶<Fax Settings>\(P. 522\)](#) .



<Menu> ▶ <Function Settings> ▶ <Send> ▶ <Fax Settings> ▶ <Change Default Settings (Fax)>  
▶ Select the setting ▶ Change the default value of the selected item ▶ <Apply> ▶

### ■ Memory Media Print

For information about changeable setting items, see [▶<Access Stored Files Settings>\(P. 538\)](#) .



<Menu> ▶ <Function Settings> ▶ <Store/Access Files> ▶ <Common Settings> ▶ <Access Stored  
Files Settings> ▶ <Change Default Settings (Memory Media Print)> ▶ Select the setting ▶ Change  
the default value of the selected item ▶ <Apply> ▶

### ■ USB Memory

For information about changeable setting items, see [▶<USB Memory Settings>\(P. 536\)](#) .



<Menu> ▶ <Function Settings> ▶ <Store/Access Files> ▶ <Common Settings> ▶ <Scan and Store  
Settings> ▶ <USB Memory Settings> ▶ <Change Default Settings (USB Memory)> ▶ Select the  
setting ▶ Change the default value of the selected item ▶ <Apply> ▶

### ■ E-Mail

For information about changeable setting items, see [▶<E-Mail Settings>\(P. 518\)](#) .



<Menu> ▶ <Function Settings> ▶ <Send> ▶ <Scan and Send Settings> ▶ <E-Mail Settings>  
▶ <Change Default Settings (E-Mail)> ▶ Select the setting ▶ Change the default value of the selected item ▶ <Apply> ▶

### ■ I-Fax

For information about changeable setting items, see <I-Fax Settings>(P. 520) .



<Menu> ▶ <Function Settings> ▶ <Send> ▶ <Scan and Send Settings> ▶ <I-Fax Settings> ▶  
<Change Default Settings (I-Fax)> ▶ Select the setting ▶ Change the default value of the selected item ▶ <Apply> ▶

### ■ Shared Folder/FTP Server

For information about changeable setting items, see <File Settings>(P. 521) .



<Menu> ▶ <Function Settings> ▶ <Send> ▶ <Scan and Send Settings> ▶ <File Settings> ▶ <Change Default Settings (File)> ▶ Select the setting ▶ Change the default value of the selected item ▶ <Apply> ▶

## NOTE

- If you select <Initialize> on each setting screen, you can restore the default settings.

## LINKS

- Basic Copy Operations(P. 191)**
- Basic Operations for Sending Faxes(P. 214)**
- Printing from a USB Memory Device (Memory Media Print)(P. 265)**
- Basic Operations for Scanning Originals(P. 279)**

## Setting Sounds

The machine produces sounds in a variety of situations, such as when fax sending is complete or when a paper jam or error occurs. You can set the volume of each of these sounds individually.

### ■ Adjusting <Fax Volume>

**1** Press the  key.

**2** Adjust the volume, and select <Apply>.

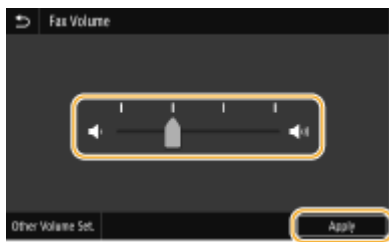

- To mute the sound, move the cursor all the way to the left.



### ■ Adjusting <Other Volume Set.>

**1** Press the  key.

- For the model without fax functionality, proceed to step 3.

**2** Select <Other Volume Set.>.

**3** Select a setting.

Setting	Description	Action
<Ring Tone>	Sound produced when an incoming fax is received	Go to step 4.
<TX Done Tone>	Sound produced when fax sending is complete	
<RX Done Tone>	Sound produced when fax receiving is complete	
<Scanning Done Tone>	Sound produced when fax original scanning is complete	

Setting	Description	Action
<Entry Tone>	Confirmation sound each time a key on the operation panel or button on the display is pressed	Select <On> (produce a tone) or <Off> (not produce a tone).
<Invalid Entry Tone>	Sound produced when an invalid key operation is performed, such as when you enter a number outside the valid setting range	
<Restock Supplies Tone>	Sound produced when a toner cartridge is almost empty	
<Warning Tone>	Sound produced when a paper jam or other error occurs	
<Job Done Tone>	Sound produced when an operation such as copying or scanning is complete	
<Energy Saver Alert>	Sound produced when the machine enters or exits sleep mode	
<Original in Feeder Detection Tone>	Sound produced when an original is loaded in the feeder	

#### 4 Adjust the volume, and select <Apply>.

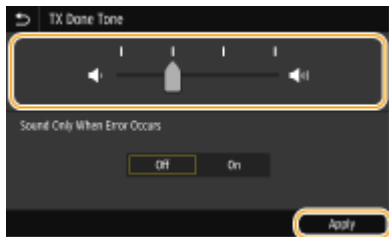

- To mute the sound, move the cursor all the way to the left.



#### ■ End sound only for error

In <Sound Only When Error Occurs>, select <On>, and select <Apply>.

## Entering Sleep Mode

261J-03H

The sleep mode function reduces the amount of power consumed by the machine by disabling power flow to the operation panel. If no operations will be performed on the machine for a while, such as during a lunch break, you can save power simply by pressing  on the operation panel.



### NOTE

#### When in sleep mode

- When the machine enters sleep mode,  lights up yellow green.

#### Situations in which the machine does not enter sleep mode

- When the machine is in operation
- When the Data indicator is lit up or blinking
- When the machine is performing an operation such as adjustment or cleaning
- When a paper jam occurs
- When the receiver of the external telephone or the optional handset is off the hook
- When the machine is set such that the fax incoming ring will not sound
- When the menu screen is displayed
- When a job is waiting to be scanned to a USB memory device or to a computer
- When an error message is displayed on the screen (There are some exceptions. The machine sometimes enters sleep mode when an error message is displayed.)
- When the machine is communicating with an LDAP server, etc.
- When the SSID/network key screen for Direct Connection is displayed
- When settings are being imported or exported

#### Changing the Auto Sleep Time Value

Auto Sleep Time is a function that automatically puts the machine into the sleep mode if it remains idle for a specified length of time. We recommend using the factory default settings (  **<Timer/Energy Settings>(P. 452)** ) to reduce power usage. If you want to change the amount of time that elapses before the machine enters the auto sleep mode, perform the procedure below.



<Menu> ► <Preferences> ► <Timer/Energy Settings> ► <Auto Sleep Time> ► Set the amount of time that elapses before the machine automatically enters sleep mode ► <Apply> ►

### Changing the Sleep Mode Setting to the Specified Time

You can configure a setting so that the machine is placed into the sleep mode at the specified time. You can also configure a setting so that the sleep mode is released at the specified time.



<Menu> ► <Preferences> ► <Timer/Energy Settings> ► Select <Auto Sleep Daily Timer> or <Sleep Mode Exit Time Settings> ► Select <On> in <Set This Function>, and enter the time ► <Apply> ►

### Exiting Sleep Mode

You can press or any other key on the operation panel to exit the sleep mode.

## NOTE

- You can also tap the display to exit sleep mode.
- If an external telephone or the optional handset is connected, the machine exits sleep mode when you take the receiver off the hook.

## Registering Destinations

261J-03J



You can register frequently used fax/scan destinations in the Address Book and easily select them when needed (▶ **Registering Destinations in the Address Book(P. 178)** ). Destinations can be searched alphabetically, from lists in the Address Book, or by entering three-digit numbers (coded dial numbers). You can also specify destinations more quickly by using the following features.

### ■ Favorites

Registering a lot of addresses in the Address Book makes it difficult to find the destination you need. To avoid this situation, register frequently used destinations as Favorites. Destinations registered in Favorites can be searched from the <★> in the Address Book.

### ■ Group Dial

You can select multiple destinations that have already been registered and register them together as a group. You can send faxes or e-mails to multiple destinations at the same time. Groups can also be registered in Favorites. ▶ **Registering Multiple Destinations as a Group(P. 181)**

### ■ Index

The registered destinations are classified into indexes depending on the initial character or the type of address. Changing indexes allows you to perform a destination search quickly. Tap ◀/▶ or flick the target index sideways to change the display.

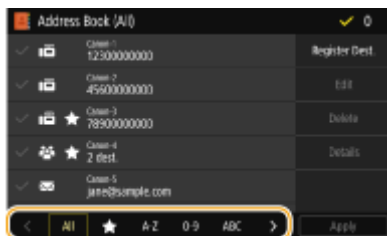

#### <All>

Displays all the destinations registered in the Address Book.



Displays a list of destinations registered in Favorites.

#### <A-Z>/<0-9>/<ABC> to <YZ>

Displays destinations with recipient names whose first characters correspond to the characters of the selected index.



Displays destinations for faxes.



Displays destinations for e-mails.





Displays destinations for I-Faxes.



Displays destinations for shared folders and FTP servers. Registration of destinations is performed from the computer.

▶ **Setting a Shared Folder as a Save Location(P. 95)**

▶ **Registering Destinations from Remote UI(P. 427)**



Displays a list of destinations registered in Group Dial.

## NOTE

- Use the computer to register a shared folder or FTP server as the destination for scans.
  - ▶ **Setting a Shared Folder as a Save Location(P. 95)**
  - ▶ **Registering Destinations from Remote UI(P. 427)**
- You can save the Address Book as a file on your computer (although you cannot use the computer to edit the Address Book). You can also import a saved Address Book from the computer to the machine. ▶ **Importing/Exporting the Setting Data(P. 437)**
- You can print a list of destinations registered in the Address Book. ▶ **Address Book List(P. 583)**
- If your office has an LDAP server installed, you can make search to find user information on the server and register it in the Address Book. You need to specify the settings for connecting to an LDAP server beforehand. ▶ **Registering LDAP Servers(P. 64)**

# Registering Destinations in the Address Book

261J-03K

This section describes how to register destinations from the operation panel. You can also use the Remote UI to register destinations. ▶ **Registering Destinations from Remote UI(P. 427)**

## 1 Select <Address Book> in the Home screen. ▶ **Home Screen(P. 121)**

## 2 Select <Register Dest.>

- If a screen appears prompting you to enter a PIN, enter the PIN for the Address Book and select <Apply>. ▶ **Restricting Use of the Address Book(P. 401)**

## 3 Select the type of address to register.



### ■ Registering destinations with the LDAP server

If your office has an LDAP server installed, you can make search to find user information on the server and register it in the Address Book.

#### NOTE:

- To make registration from the LDAP server, you need to specify the settings for connecting to the LDAP server beforehand. ▶ **Registering LDAP Servers(P. 64)**

### 1 Select <LDAP Server>.

### 2 Select the LDAP server you are using.

### 3 Select conditions for user information to be searched.

- Name, fax numbers, e-mail addresses, organization names, and organization unit are available criteria for searching destinations.

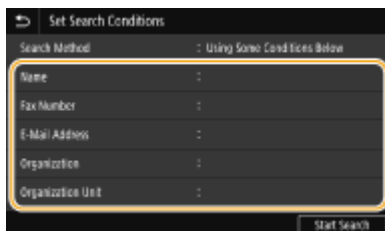

### 4 Enter the search target character string, and select <Apply>.

- On how to enter text, see ▶ **Entering Text(P. 130)** .
- To specify multiple search criteria, repeat steps 3 and 4.

### 5 Select <Search Method>.

- 6 Select conditions to display the search result.

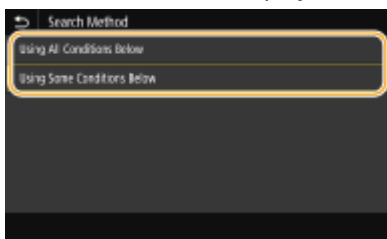

**<Using All Conditions Below>**

Searches and displays the users that meet all the search criteria specified in steps 3 and 4.

**<Using Some Conditions Below>**

If users that meet even one of the criteria specified in steps 3 and 4 are found, displays all those users.

- 7 Select <Start Search>.

▣▣▣▣ The users meeting your search criteria are displayed.

**NOTE:**

- If the authentication screen appears when you select <Start Search>, enter the user name of the machine and the password registered in the LDAP server, and select <Apply>. **▶ Registering LDAP Servers(P. 64)**

- 8 Select a user you want to register in the Address Book.

- 9 Select <Apply>.

▣▣▣▣ The user name and the fax number or e-mail address registered on the LDAP server of the selected user are registered in the Address Book.

**■ Registering destinations from recall settings**

If recall settings are provided, you can select <Recall Settings> and register the destinations.

- 4 Select <Name>.

- Registering <Name> is optional. If you register <Name>, the destination can be searched alphabetically.

- 5 Enter the name, and select <Apply>.

- On how to enter text, see **▶ Entering Text(P. 130)** .

- 6 Select <Fax Number>, <E-Mail Address>, or <I-Fax Address>.

- 7 Enter the destination, and select <Apply>.

**■ Making detailed settings (only when registered for fax)**

After selecting <Set Details>, a screen similar to the following is displayed.

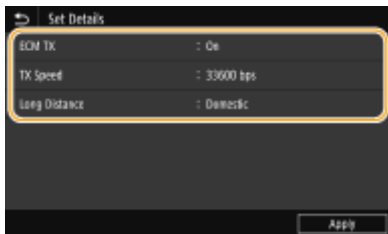

### <ECM TX>

If an error occurs in an image that is being sent, the error is checked and corrected to prevent an improper image from being sent when setting <On>.

### <TX Speed>

If it takes time for transmissions to start, such as when there is a poor telephone connection, you can adjust the transmission start speed downward.

### <Long Distance>

Specify <International (1)> to <International (3)> according to the transmission conditions when registering overseas fax numbers.

## NOTE

- You can also specify <ECM TX> and <TX Speed> from <Menu> ► <Function Settings> ► <Send> ► <Fax Settings>. However, settings made from <Address Book> are enabled for the detailed settings of destinations registered in the Address Book.

## 8 Select <Register As>.

## 9 Select <Favorites> or <Coded Dial>.

- If you select <Coded Dial>, select the destination number, or select <Use Numeric Keys> and enter the destination number.

## 10 Select <Apply>.

## NOTE

- You can make a group of destinations already registered in the Address Book and register it as one destination. For more information, see ► **Registering Multiple Destinations as a Group(P. 181)** .
- When you want to change or delete items of information about destinations registered in the Address Book, see ► **Editing the Registered Destinations in the Address Book(P. 183)** .

# Registering Multiple Destinations as a Group

261J-03L

You can select multiple destinations that have already been registered and register them together as a group. This section describes how to register a group from the operation panel. You can also use the Remote UI to register a group. [▶Registering Destinations from Remote UI\(P. 427\)](#)

## NOTE

- Only destinations of the same type of address can be registered in the same group.
- Shared folders or FTP servers cannot be registered in a group as destinations.

**1** Select **<Address Book>** in the Home screen. [▶Home Screen\(P. 121\)](#)

**2** Select **<Register Dest.>** ▶ **<Group>**.

- If a screen appears prompting you to enter a PIN, enter the PIN for the Address Book and select **<Apply>**. [▶ Restricting Use of the Address Book\(P. 401\)](#)

**3** Select **<Name>**.

- Registering **<Name>** is optional. If you register **<Name>**, the destination can be searched alphabetically.

**4** Enter the name, and select **<Apply>**.

- On how to enter text, see [▶Entering Text\(P. 130\)](#) .

**5** Select **<Destination>**.

**6** Select **<Add>**.

**7** Select the index containing the destination you want to register. [▶Index\(P. 176\)](#)

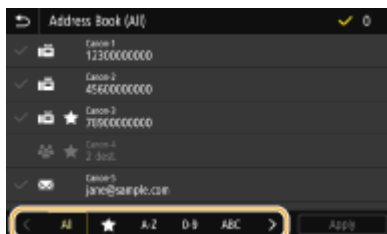

**8** Select the destination.

**9 Repeat steps 6 to 8 until you have registered all of the destinations that you want to register, and then select <Apply>.**

**NOTE:**

**To view information about the destination**

- Select the target destination, and select <Details>.

**To remove a destination from the group**

- Select the destination that you want to remove from the group, and select <Delete> ► <Yes>.

**10 Select <Register As>.**

**11 Select <Favorites> or <Coded Dial>.**

- If you select <Coded Dial>, select the destination number, or select <Use Numeric Keys> and enter the destination number.

**12 Select <Apply>.**

# Editing the Registered Destinations in the Address Book

261J-03R

You can change your settings, such as changing a registered fax number or name, changing the type of destination registered as a fax number to an e-mail destination, changing a coded dial number, and adding or deleting group destinations. You can also delete destinations or groups.

## NOTE

- If you delete a destination from the Address Book, it is also deleted from the favorite settings. ▶ **Registering Frequently Used Settings(P. 168)**

**1** Select <Address Book> in the Home screen. ▶ **Home Screen(P. 121)**

**2** Select the index containing the destination you want to edit. ▶ **Index(P. 176)**

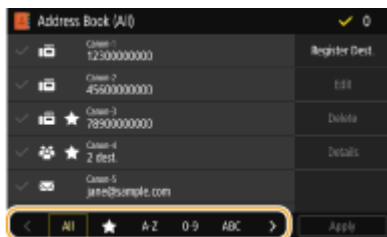

**3** Select the destination, and select <Edit>.

- If you select <Details>, you can view information about the destination.
- To delete the destination, select <Delete> ▶ <Yes>.
- If a screen appears prompting you to enter a PIN, enter the PIN for the Address Book and select <Apply>. ▶ **Restricting Use of the Address Book(P. 401)**

**4** After editing the necessary items, select <Apply>.

## Using a USB Memory Device

261J-022

When using a USB memory, insert it into the USB port on the machine.

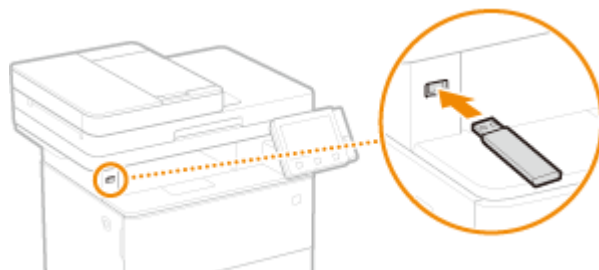

### IMPORTANT

#### Before using a USB memory device

- The supported formats of USB memory device are FAT16 and FAT32.

#### The following devices and uses are not supported:

- USB memory devices that have security functions installed
- USB memory devices that do not meet the USB standards
- Memory card readers connected via USB
- USB memory devices that are used with extension cables
- USB memory devices used via a USB hub

#### Handling of USB memory devices

- Make sure that the USB memory device is correctly oriented before inserting it. If you attempt to insert it in incorrect orientation, the memory device and the machine may be damaged.
- Do not remove, bump or otherwise move the USB memory device while data is being imported or exported. Also, do not turn OFF the machine while processing is in progress.
- You may not be able to save data properly on some USB memory devices.

### ■ Remove the USB Memory Device

### IMPORTANT

- Always use the following procedure when removing USB memory devices. Using other methods to remove USB memory devices may result in damage to the device and the machine.

- 1 Select <Status Monitor>.
- 2 Select <Rmv. Mem. Media>.
  - ▢ Wait until the <The memory media can be safely removed.> message is displayed.
- 3 Disconnect the USB memory device.

### LINKS



- ▶ **Printing from a USB Memory Device (Memory Media Print)(P. 265)**
- ▶ **Saving Data to a USB Memory Device(P. 282)**

# Copying

<b>Copying</b> .....	187
<b>Copy Basic Features Screen</b> .....	189
<b>Basic Copy Operations</b> .....	191
Canceling Copies .....	196
Checking the Copying Status and Log .....	197
<b>Enhancing and Adjusting Copy Quality</b> .....	199
Selecting the Type of Original for Copying .....	200
Adjusting Sharpness for Copying (Sharpness) .....	201
Erasing Dark Borders When Copying (Erase Frame) .....	202
<b>Useful Copy Functions</b> .....	203
Copying Multiple Documents onto One Sheet (N on 1) .....	204
Collating Copies by Page .....	205
Making ID Card Copies .....	206
Making Passport Copies .....	207

# Copying

261J-03S

This chapter describes basic copy operations and various useful copy functions.

## ■ Using Basic Operations

- ▶ Copy Basic Features Screen(P. 189)
- ▶ Basic Copy Operations(P. 191)
- ▶ Canceling Copies(P. 196)
- ▶ Checking the Copying Status and Log(P. 197)

## ■ Enhancing Quality ▶ Enhancing and Adjusting Copy Quality(P. 199)



▶ Selecting the Type of Original for Copying(P. 200)

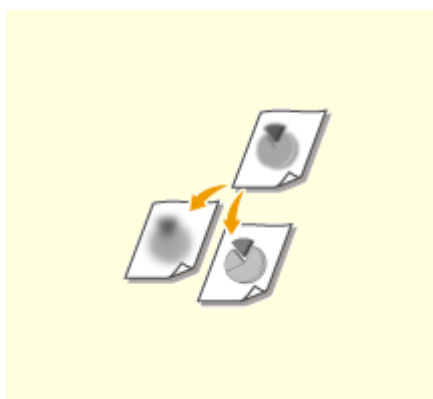

▶ Adjusting Sharpness for Copying (Sharpness)(P. 201)

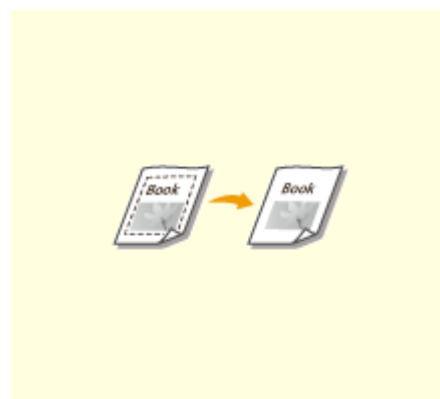

▶ Erasing Dark Borders When Copying (Erase Frame)(P. 202)

## ■ Using Useful Copy Functions ▶ Useful Copy Functions(P. 203)



▶ Copying Multiple Documents onto One Sheet (N on 1)(P. 204)



▶ Collating Copies by Page(P. 205)



▶ Making ID Card Copies(P. 206)

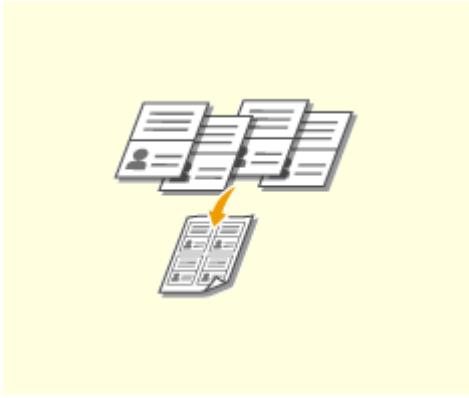

▶ Making Passport Copies(P. 207)

# Copy Basic Features Screen

261J-03U

When you select <Copy> in the Home screen, the Copy Basic Features screen appears.



## 1 Current setting status and setting buttons

The setting status, such as copy ratio, copy paper, and number of copies, are displayed. To copy correctly, be sure to check the settings displayed here. When you want to change a setting, select the desired setting item.

▶ **Basic Copy Operations(P. 191)**

## 2 <2-Sided>

You can select a combination of 1-sided copying and 2-sided copying for the original and printout paper. Specify the detailed settings from **4** <Other Settings>. ▶ **Basic Copy Operations(P. 191)**

	Scans one side of an original and prints the scanned data on one side of the paper.
	Scans one side of an original and prints the scanned data on both sides of the paper.
	Scans both sides of an original and prints the scanned data on both sides of the paper.
	Scans both sides of an original and prints the scanned data on one side of the paper.

## 3 <N on 1>

You can select an "N on 1" pattern to arrange multi-page originals on the same side of one sheet. Specify the detailed settings from **4** <Other Settings>. ▶ **Copying Multiple Documents onto One Sheet (N on 1) (P. 204)**

	Does not apply N on 1.
	Prints data for two consecutive pages on one side of a sheet of paper.
	Prints data for four consecutive pages on one side of a sheet of paper.

## 4 <Other Settings>

You can call the detailed settings or favorite settings that are not displayed in the Copy Basic Features screen.

**5 <Reset>**

You can collectively restore the default settings.

**6 <Start>**

Use this button to start copying.

# Basic Copy Operations

This section describes the basic operation procedure used to copy an original.

- 1 Place the original(s).** ▶ **Placing Originals(P. 134)**
- 2 Select <Copy> in the Home screen.** ▶ **Home Screen(P. 121)**
- 3 Select <Number of Copies> in the Copy Basic Features screen.** ▶ **Copy Basic Features Screen(P. 189)**
- 4 Enter the number of copies, and select <Close>.**
  - If you have entered an incorrect value, use **C** to clear it.
- 5 Specify the copy settings as necessary.**
  - ▶ **Adjusting Density**
  - ▶ **2-Sided Copying**
  - ▶ **Enlarging or Reducing**
  - ▶ **Selecting Copy Paper**

## Adjusting Density



Adjust the density of the scan if the text or images in an original are excessively light or dark. For example, you can sharpen text and lines written using a pencil. ▶ **Adjusting Entire Density(P. 191)**



Adjust the background density. You can make a clear copy of originals with colored backgrounds, or originals such as a newspaper that is printed on thin paper on which text or images on the other side are visible through the paper. ▶ **Adjusting the Background Density(P. 192)**

### ■ Adjusting Entire Density



<Density> ▶ Adjust the density ▶ <Close>

## ■ Adjusting the Background Density



<Density> ▶ <Adjust Background Density> ▶ <Adjust (Manual)> ▶ Adjust the background density ▶ <Apply> ▶ <Close>

### NOTE

- Depending on the original color, portions other than the background may be affected.
- When you set <Adjust Background Density> to <Auto>, automatic adjustment is performed so that the background color becomes white. In this case, <Original Type> is automatically set to <Text> ( ▶ **Selecting the Type of Original for Copying(P. 200)** ).

## 2-Sided Copying



You can copy two pages of an original on both sides of the paper. You can also copy a 2-sided original on both sides of the paper, or on two sheets of paper.

### NOTE

- <2-Sided Printing> may not be available with some sizes and types of paper. ▶ **Available Paper(P. 673)**



<Other Settings> ▶ <2-Sided Printing> ▶ Select the type of 2-sided copying ▶ <Apply>



### a Types of 2-sided copying

The illustration below shows the types of 2-sided copying.

<1-Sided->2-Sided>

<2-Sided->2-Sided>

<2-Sided->1-Sided>



## Copying



### b <Orig./Fin. Type>

Specify the original orientation, opening type, and finishing type.

## Enlarging or Reducing



You can enlarge or reduce copies by using a preset copy ratio such as <A5->A4>, or by setting a custom copy ratio in increments of 1 %.

## NOTE

- If you make a setting for <N on 1> after setting the copy ratio, the setting of reduction ratio in <N on 1> takes priority.



<Copy Ratio> ▶ Select the copy ratio



### a <100% 1:1>

Makes copies at copy ratio 100%.

### b <Auto>

Makes copies by automatically enlarging/reducing the original image to fit the specified paper size.

### c Preset copy ratio

Select a copy ratio.

### d Numeric keys

You can set any copy ratio from 25% to 400% in 1% increments.

## Selecting Copy Paper

Specify the paper source that contains the paper to use for printing out copies.

**NOTE**

- You must first specify the size and type of paper that is loaded in the paper source.
  - ▶ **Specifying Paper Size and Type(P. 154)**
  - ▶ **Loading Paper(P. 138)**

 <Paper> ▶ Select the paper source ▶ <Close>

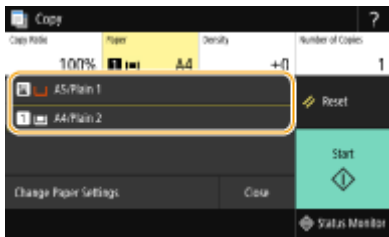

	Uses the paper that is loaded in the multi-purpose tray to make copies.
<b>1</b>	Uses the paper that is loaded in the paper drawer (Drawer 1) of the machine to make copies.

**NOTE**

- When the optional paper feeder is installed, its paper drawer is also displayed.

**NOTE:**

- For information about other copy settings, see ▶ **Enhancing and Adjusting Copy Quality(P. 199)** or ▶ **Useful Copy Functions(P. 203)** .

### 6 Select <Start>.

⇒ Copying starts.

- If you want to cancel, select <Cancel> ▶ <Yes>. ▶ **Canceling Copies(P. 196)**

**■When placing originals in the feeder in step 1**

The original is automatically scanned.

**■When placing originals on the platen glass in step 1**

For 2-sided copying or N on 1 copying, the screen prompting you to load the next original is displayed.

- Place the next original on the platen glass, and select <Scan Next Original>.
  - You can also specify <Density> and <Original Type> separately for each original.

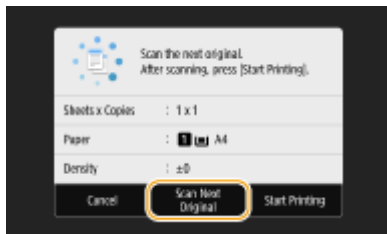

- Repeat this step until you finish scanning the entire original.

2 Select <Start Printing>.

## NOTE:

- When the <Paper Settings and Loaded Size Mismatch> or <The memory is full. Scanning will be canceled. Do you want to print?> message is shown in the display. [▶Countermeasures for Each Message\(P. 618\)](#)

## IMPORTANT

### When copying originals with text or images that extend to the edges of the page

- The edges of the original might not be copied. For more information about the scan margins, see [▶Main Unit\(P. 669\)](#) .

## TIPS

- If you always want to make copies with the same settings: [▶Changing the Default Settings for Functions\(P. 170\)](#)
- If you want to register a combination of settings to use when needed: [▶Registering Frequently Used Settings\(P. 168\)](#)

## LINKS

- [▶Checking the Copying Status and Log\(P. 197\)](#)

## Canceling Copies

261J-03X

If you want to cancel copying immediately after selecting <Start>, select <Cancel> on the screen or press  on the operation panel. You can also cancel copying after checking the copy status.

### ■ Select <Cancel> on the Screen That is Displayed While Copying

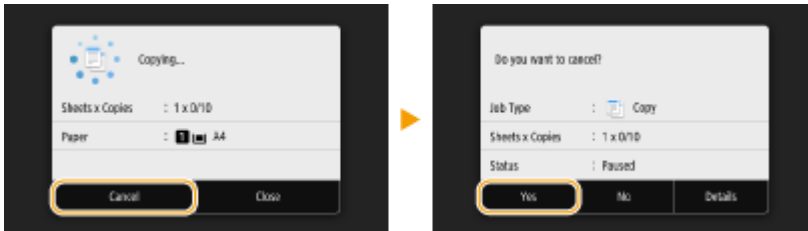

### ■ Press to Cancel

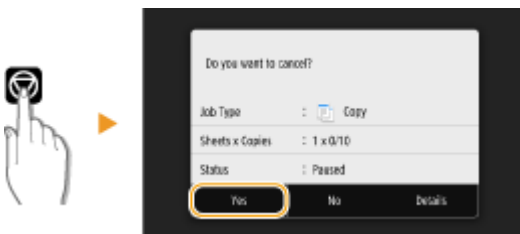

### If the Screen Displays a List of Documents When is Pressed

Originals have been scanned and are waiting to be printed. Select a copy document to be canceled, and select <Cancel> ► <Yes>.



### ■ Check the copy job status before canceling



<Status Monitor> ► <Copy/Print Job> ► Select the copy document in the <Copy/Print Job Status> tab ► <Cancel> ► <Yes>

## LINKS

▶ **Basic Copy Operations(P. 191)**

# Checking the Copying Status and Log

261J-03Y

You can check the current copy statuses and the logs for copied documents.

## IMPORTANT

- When <Display Job Log> is set to <Off>, you cannot check the copy job log. ▶<Display Job Log>(P. 547)

### Useful in the Following Cases

- When some long time has already passed after scanning of your original to be copied but printing of the document has not started yet, you may want to see the waiting list of the documents waiting to be printed.
- When you cannot find your printouts that you thought had been copied, you may want to see whether an error has occurred.

**1** Select <Status Monitor>.

**2** Select <Copy/Print Job>.

**3** Check the copy statuses and logs.

#### ■To check the copy statuses

- 1** Select the document whose status you want to check in the <Copy/Print Job Status> tab.

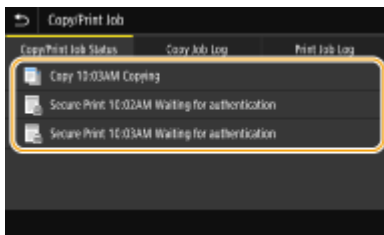

▢▢▢▢▢ Displays detailed information about the document.

#### ■To check the copy logs

- 1** Select the document whose log you want to check in the <Copy Job Log> tab.
- <OK> is displayed when a document was copied successfully, and <Error> is displayed when a document failed to be copied because it was canceled or there was some error.

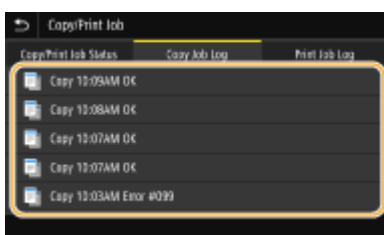

▣▣▣ Displays detailed information about the document.

## NOTE:

When a three-digit number is shown in the case of <Error>

- This number represents an error code. ▶ **Countermeasures for Each Error Code(P. 632)**

## LINKS

---

▶ **Basic Copy Operations(P. 191)**

▶ **Canceling Copies(P. 196)**

## Enhancing and Adjusting Copy Quality

261J-040

You can improve the copy quality by specifying more detailed settings, such as selecting the optimum image quality, erasing unnecessary shadows, etc.

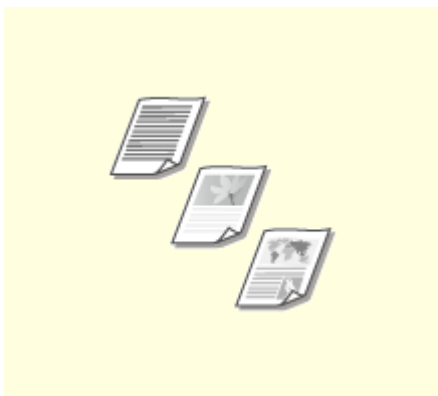

▶ **Selecting the Type of Original for Copying(P. 200)**

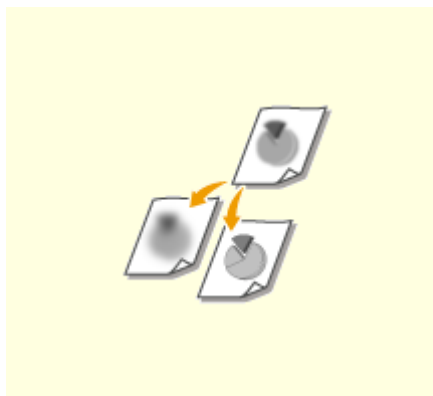

▶ **Adjusting Sharpness for Copying (Sharpness)(P. 201)**

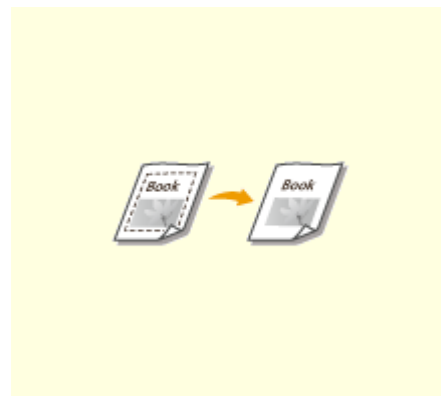

▶ **Erasing Dark Borders When Copying (Erase Frame)(P. 202)**

## Selecting the Type of Original for Copying

261J-041



You can select the optical image quality for the copy depending on the original type, such as text-only documents, documents with charts and graphs, or magazine photos.



<Copy> ▶ <Other Settings> ▶ <Original Type> ▶ Select the original type

<Text/Photo>	Suitable when copying documents that contain both text and photos.
<Text/Photo (High Quality)>	Suitable when making a high quality copy of documents that contain both text and photos. You can also adjust the level of priority given to the quality of the text or photos. Adjust the setting on the scale, and select <Apply>.

### NOTE

- If a setting other than <Text> is specified, <Adjust Background Density> is automatically set to <Adjust (Manual)>. ▶ **Basic Copy Operations(P. 191)**

### LINKS

▶ **Basic Copy Operations(P. 191)**



# Adjusting Sharpness for Copying (Sharpness)

261J-042



You can adjust sharpness of the copied image. Increase the sharpness to sharpen blurred text and lines, or decrease the sharpness to improve the appearance of magazine photos.

 <Copy> ▶ <Other Settings> ▶ <Sharpness> ▶ Adjust the sharpness ▶ <Apply>

**Example:** If you want to sharpen text and lines written in pencil

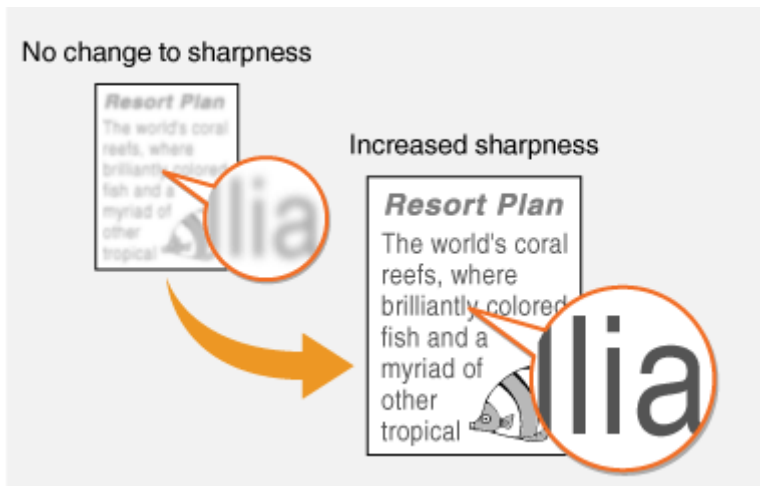

**Example:** If you want to improve the appearance of magazine photos

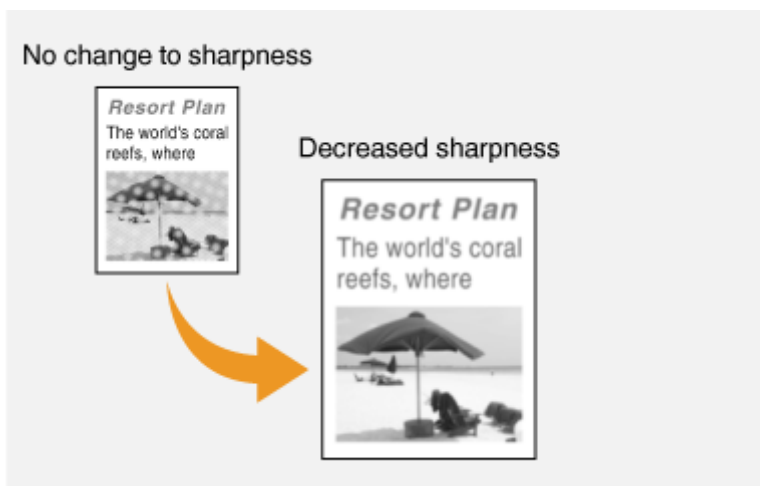

LINKS

▶ **Basic Copy Operations(P. 191)**

## Erasing Dark Borders When Copying (Erase Frame)

261J-043



When copying originals that are smaller than the output paper size, frame lines may appear around the edges in the copied image. When copying facing pages from thick book, dark borders may appear. <Erase Frame> enables you to erase these frame lines and dark borders.

### NOTE

- The width of the frame to erase is increased or decreased relative to the <Copy Ratio> setting.
- <Erase Frame> is not available when using <N on 1>.



<Copy> ▶ <Other Settings> ▶ <Erase Frame> ▶ <On> ▶ Specify the width of the frame to erase ▶ <Next> ▶ Select the original size on the <Scan Size> screen

**Example:** If you want to erase the dark borders and frame lines

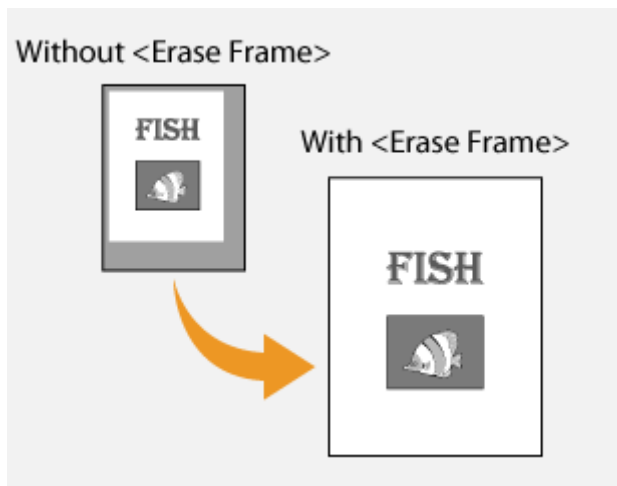

### LINKS

🔗 [Basic Copy Operations\(P. 191\)](#)

## Useful Copy Functions

261J-044

This section describes useful copy functions to save paper and improve copying operation efficiency.



▶ Copying Multiple Documents onto One Sheet (N on 1)(P. 204)

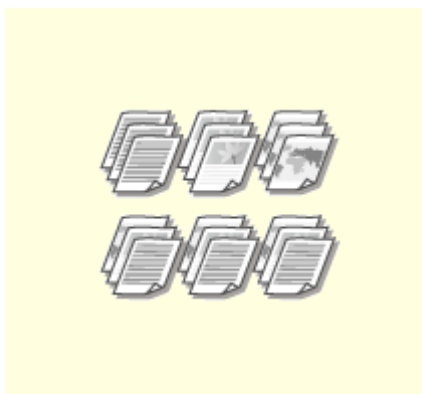

▶ Collating Copies by Page(P. 205)



▶ Making ID Card Copies(P. 206)



▶ Making Passport Copies(P. 207)

## Copying Multiple Documents onto One Sheet (N on 1)

261J-045



You can reduce the size of a multiple-page original and arrange all pages on one side of the paper. You can save the number of sheets as the document can be copied on fewer pages than those of the original.

### NOTE

- Using <N on 1> reduces the copy ratio automatically (the copy ratio is displayed on the screen). If the copying process has not started, you can further reduce the image size by lowering the numeric value that is automatically displayed. But the edges of the original might not be copied if you increase it.
- <N on 1> is not available when using <Erase Frame>.
- When you copy multiple originals onto one page, margins may be created in the copied image.



<Copy> ▶ <Other Settings> ▶ <N on 1> ▶ Select the number of pages to be combined, and select <Next> ▶ Select the original size on the <Scan Size> screen ▶ On the <Output Size> screen, select the paper source that contains the paper you want to use



#### **a** Number of pages to be combined

Select the number of pages to be combined on one side of paper. For example, <4 on 1> means that "a four-page original can be combined on a single sheet."

#### **b** <Layout>

Specify how to arrange the originals on the page.

### LINKS

▶ **Basic Copy Operations(P. 191)**

## Collating Copies by Page

261J-046



When preparing multiple copies of multi-page originals, set <Collate> to <On> to collate copies in sequential page order. This function is useful when preparing handouts for meetings or presentations.



<Copy> ▶ <Other Settings> ▶ <Collate> ▶ <On>

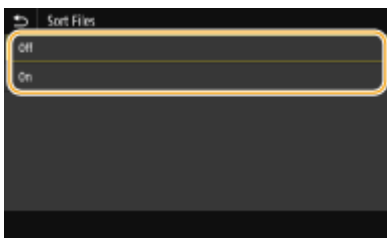

### <Off>

The copies are grouped by page and not collated. For example, if you are making three copies of a five-page original, the printouts will be arranged in the following page order: 1, 1, 1, 2, 2, 2, 3, 3, 3, 4, 4, 4, 5, 5, 5.



### <On>

The copies are grouped into complete sets in sequential page order. For example, if you are making three copies of a five-page original, the printouts will be arranged in the following page order: 1, 2, 3, 4, 5, 1, 2, 3, 4, 5, 1, 2, 3, 4, 5.



## LINKS

▶ **Basic Copy Operations(P. 191)**

## Making ID Card Copies

261J-047



You can use <ID Card Copy> to copy the front and back sides of a card onto the same side of a page. This function is useful when copying a driver's license or ID card.

### NOTE

- <Copy Ratio> is automatically set to <100% 1:1>.



Place the card on the platen glass ▶ <ID Card Copy> ▶ <Start> ▶ Turn the card over ▶ <Scan Next Original>

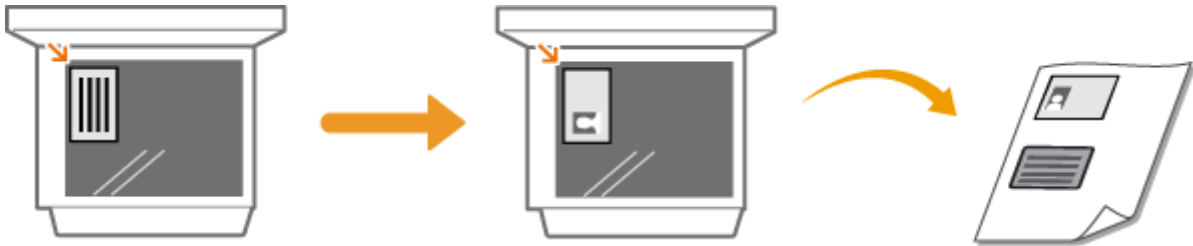

### LINKS

▶ **Basic Copy Operations(P. 191)**

# Making Passport Copies

261J-048



You can copy multiple passports onto one sheet.

- 1 Place the passport with the desired pages open on the platen glass. [▶Placing Originals\(P. 134\)](#)

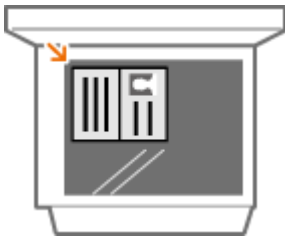

- 2 Select <Passport Copy> in the Home screen. [▶Home Screen\(P. 121\)](#)

- 3 Select the layout.

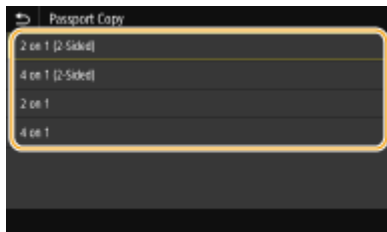

### <2 on 1 (2-Sided)>

Copies four facing pages of passports onto one side of paper in total. Copies eight facing pages of passports onto both sides of paper in total.

### <4 on 1 (2-Sided)>

Copies eight facing pages of passports onto one side of paper in total. Copies 16 facing pages of passports onto both sides of paper in total.

### <2 on 1>

Copies four facing pages of passports onto one side of paper in total.

### <4 on 1>

Copies eight facing pages of passports onto one side of paper in total.

- 4 Select the paper source that contains the paper you want to use.

- 5 Configure the copy settings as necessary. [▶Basic Copy Operations\(P. 191\)](#)

## 6 Select <Start>.

▣ The first passport is scanned.

## 7 Place the next passport on the platen glass, and select <Scan Next Original>.

- You can also specify <Density> and <Original Type> separately for each passport.
- Repeat this step until you finish scanning all of the passports.

## 8 Select <Start Printing>.

### LINKS

---

▶ **Basic Copy Operations(P. 191)**



# Faxing

<b>Faxing</b> .....	210
<b>Fax Basic Features Screen</b> .....	213
<b>Basic Operations for Sending Faxes</b> .....	214
Canceling Sending Faxes .....	222
<b>Receiving Faxes</b> .....	223
<b>Useful Functions When Sending</b> .....	226
Recalling Previously Used Settings for Sending (Recall Settings) .....	227
Sending a Fax after a Phone Call (Manual Sending) .....	230
Saving a Copy of a Sent Original .....	232
<b>Various Receiving Methods</b> .....	233
Saving Received Documents into the Machine (Memory Reception) .....	234
<b>Forwarding the Received Documents Automatically</b> .....	236
<b>Checking Status and Log for Sent and Received Documents</b> .....	238
<b>Sending Faxes from Your Computer (PC Fax)</b> .....	240
Sending PC Faxes .....	241
<b>Using Internet Fax (I-Fax)</b> .....	243
Sending I-Faxes .....	244
Receiving I-Faxes .....	251

# Faxing

261J-049

This chapter describes fax settings, basic fax operations and various other useful functions to suit your needs, such as PC Fax to send documents directly from computers, Address Book to specify destinations easily, and Forwarding to receive faxes even when you are out of the office.

## NOTE

- You need to complete some procedures before using fax functions. **▶Configuring Initial Settings for Fax Functions(P. 79)**
- You need to register destinations in the Address Book before using this feature. **▶Registering Destinations(P. 176)**

### ■ Using Basic Operations

- ▶Fax Basic Features Screen(P. 213)
- ▶Basic Operations for Sending Faxes(P. 214)
- ▶Canceling Sending Faxes(P. 222)
- ▶Receiving Faxes(P. 223)
- ▶Checking Status and Log for Sent and Received Documents(P. 238)

### ■ Using Useful Functions When Sending **▶Useful Functions When Sending(P. 226)**



▶Recalling Previously Used Settings for Sending (Recall Settings)(P. 227)



▶Sending a Fax after a Phone Call (Manual Sending)(P. 230)

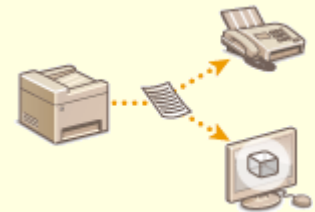

▶Saving a Copy of a Sent Original(P. 232)

■ Receiving According to Your Purposes ▶ **Various Receiving Methods(P. 233)**

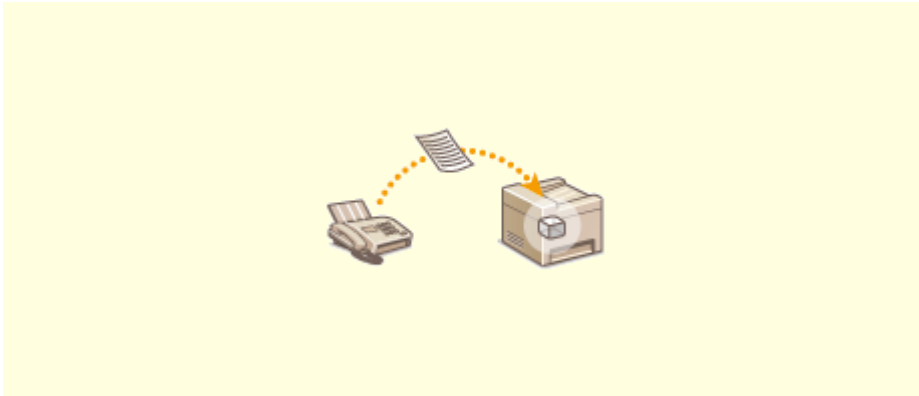

▶ **Saving Received Documents into the Machine (Memory Reception)(P. 234)**

■ Forwarding All the Received Documents



▶ **Forwarding the Received Documents Automatically(P. 236)**

■ Sending Faxes Directly from Your Computer



▶ **Sending Faxes from Your Computer (PC Fax)(P. 240)**

■ Sending and Receiving Faxes via the Internet



▶ Using Internet Fax (I-Fax)(P. 243)

## Fax Basic Features Screen

261J-04A

Selecting <Fax> in the Home screen displays the FAX Basic Features screen that appears when you sending faxes.



### 1 <Enter Dest.> tab

Select this tab to directly enter a destination.

### 2 <Specify Destination> tab

Select this tab to search for an LDAP server, enter a coded dial, or specify a destination using the recall settings.

- ▶ **Basic Operations for Sending Faxes(P. 214)**
- ▶ **Recalling Previously Used Settings for Sending (Recall Settings)(P. 227)**

### 3 <TX/RX Settings> tab

Select this tab to specify the scanning settings. You can change the RX mode ( ▶ **Deciding Which Fax Receive Mode to Use(P. 80)** ) of the machine.

### 4 <Confirm Destination>

You can check the name and fax number of specified destinations as well as the number of specified destinations. You can also change the fax number or cancel specification of destinations.

### 5 <Address Book>

Specify destinations registered in the Address Book.

### 6 <Reset>

You can collectively restore the default settings.

### 7 <Start>

Use this button to start faxing.

# Basic Operations for Sending Faxes

261J-04C

This section describes the basic operation procedure used to fax an original.

## NOTE

- You need to complete some procedures before using fax functions. [▶Configuring Initial Settings for Fax Functions\(P. 79\)](#)

### 1 Place the original(s). [▶Placing Originals\(P. 134\)](#)

### 2 Select <Fax> in the Home screen. [▶Home Screen\(P. 121\)](#)

- If the login screen appears, specify the user name, the password, and the authentication server. [▶Logging in to Authorized Send\(P. 132\)](#)

### 3 Select <Reset> in the Fax Basic Features screen. [▶Fax Basic Features Screen\(P. 213\)](#)

- If the destinations set by the previous user are still selected, this can cause transmission errors. Always reset the settings before sending.

### 4 Specify the destination.

- [▶Specifying from Address Book](#)
- [▶Specifying from Coded Dial Numbers](#)
- [▶Entering Destinations Directly](#)
- [▶Specifying Destinations in an LDAP Server](#)

## Specifying from Address Book



The Address Book enables you to specify a destination by selecting from a list of registered destinations or by searching by name for destinations with recipient names.

## NOTE

- You need to register destinations in the Address Book before using this feature. [▶Registering Destinations\(P. 176\)](#)

### 1 Select <Address Book>.

### 2 Select an index. [▶Index\(P. 176\)](#)

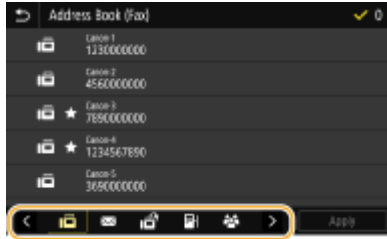

**3** Select the check box for the desired destination, and select <Apply>.

**TIPS**

- If a destination is selected from <Address Book> in the Home screen, the Fax Basic Features screen can be displayed while the selected destination remains being specified.

Specifying from Coded Dial Numbers



Three-digit numbers (coded dial numbers) are assigned to addresses in the Address Book. You can specify an address simply by entering its coded dial number.

**NOTE**

- To use coded dial numbers, the destination must be registered in the Address Book beforehand. ▶ **Registering Destinations(P. 176)**

**1** Select <Coded Dial> in the <Specify Destination> tab.

**2** Enter a three-digit number.

- If you have entered an incorrect value, use **C** to clear it.

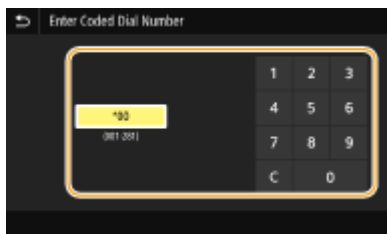

**NOTE:**

**If a confirmation screen appears**

- When <Confirm When Coded Dial TX> is set to <On>, a screen is displayed that shows the destination and the name for the number. (For Group Dial, the destination name and the number of destinations are shown.) Check the contents and if everything is correct, select <OK>. To specify a different destination, select <Cancel> and then re-enter the three-digit coded dial number. ▶ **Displaying Destinations in Address Book(P. 403)**

## Entering Destinations Directly

For a destination that is not registered in the Address Book, specify it by entering a fax number.

### 1 Enter the fax number in the <Enter Dest.> tab.

- If your machine is connected to a PBX (Private Branch Exchange), select <R> before entering the destination. If <R> is not available, you need to register the R-key settings. ▶<R-Key Setting>(P. 526)
- If you have entered an incorrect value, use  to clear it.

## NOTE

### Adding a destination

- To enter a second or subsequent destination, select <Next Dest.>.

### If a confirmation screen appears

- When <Confirm Entered Fax Number> is set to <On>, the input screen reappears so that you can confirm the destination ( ▶<Confirming the Entered Fax Number(P. 405) ). Enter the destination again.

### Sending a fax abroad

- Enter the international access code, the country code, and the fax number to specify the destination. If you are not able to successfully connect to a recipient, select <Pause> and insert a pause between numbers.

## Specifying Destinations in an LDAP Server



If your office has an LDAP server installed, you can specify a destination using user information in the server. Access the LDAP server via the machine to search for the appropriate user information and specify it as destination.

## NOTE

- You need to specify the settings for connecting to an LDAP server beforehand. ▶<Registering LDAP Servers(P. 64)

### 1 Select <LDAP Server> in the <Specify Destination> tab.

### 2 Select the LDAP server you are using.

### 3 Select conditions for user information to be searched.



- Name, fax numbers, e-mail addresses, organization names, and organization unit are available criteria for searching destinations.

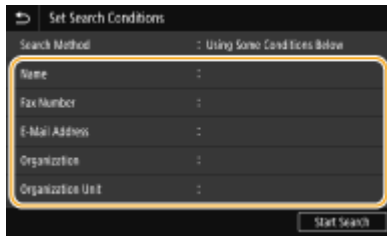

#### 4 Enter the search target character string, and select <Apply>.

- On how to enter text, see [▶Entering Text\(P. 130\)](#) .
- To specify multiple search criteria, repeat steps 3 and 4.

#### 5 Select <Search Method>.

#### 6 Select conditions to display the search result.

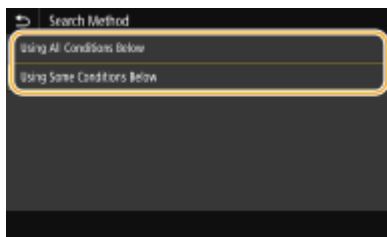

##### <Using All Conditions Below>

Searches and displays the users that meet all the search criteria specified in steps 3 and 4.

##### <Using Some Conditions Below>

If users that meet even one of the criteria specified in steps 3 and 4 are found, displays all those users.

#### 7 Select <Start Search>.

⇒ The users meeting your search criteria are displayed.

#### NOTE:

- If the authentication screen appears when you select <Start Search>, enter the user name of the machine and the password registered in the LDAP server, and select <Apply>. [▶Registering LDAP Servers\(P. 64\)](#)

#### 8 Select the check box for the user that you want to specify as destination, and select <Apply>.

#### NOTE:

##### Adding a destination

- To send a fax to multiple destinations at a time (sequential broadcast), repeat the appropriate steps to enter all destinations.
- You can also recall previously used destinations. [▶Recalling Previously Used Settings for Sending \(Recall Settings\)\(P. 227\)](#)

## ■ To delete destinations

If you specified multiple destinations, you can delete destinations as necessary.

- 1 Select <Confirm Destination>.
- 2 Select the check box for the destination to be deleted, and select <Remove from Dest.>.
  - If you select the Group Dial check box, you can view the destinations registered in the group by selecting <Details> ► <Destination>.
- 3 Select <Yes>.

## 5 Specify the scanning settings as necessary.

- ▶ Adjusting Image Quality
- ▶ Scanning 2-Sided Originals

### Adjusting Image Quality



You can select the resolution suitable for your original type. The higher the resolution is, the clearer the image becomes, but the longer it takes to send. ▶ **Selecting Resolution(P. 218)**



You can adjust the density of the fax if the text or images in an original are too light or dark. ▶ **Adjusting Density(P. 218)**



You can adjust the sharpness of the image. Increase the sharpness to sharpen blurred text and lines, or decrease the sharpness to improve the appearance of magazine photos. ▶ **Adjusting Sharpness(P. 219)**

## ■ Selecting Resolution



Select <Resolution> in the <TX/RX Settings> tab ► Select the resolution

## ■ Adjusting Density



Select <Density> in the <TX/RX Settings> tab ► Adjust the density ► <Apply>

## ■ Adjusting Sharpness



Select <Sharpness> in the <TX/RX Settings> tab ▶ Adjust the sharpness ▶ <Apply>

**Example:** If you want to sharpen text and lines written in pencil

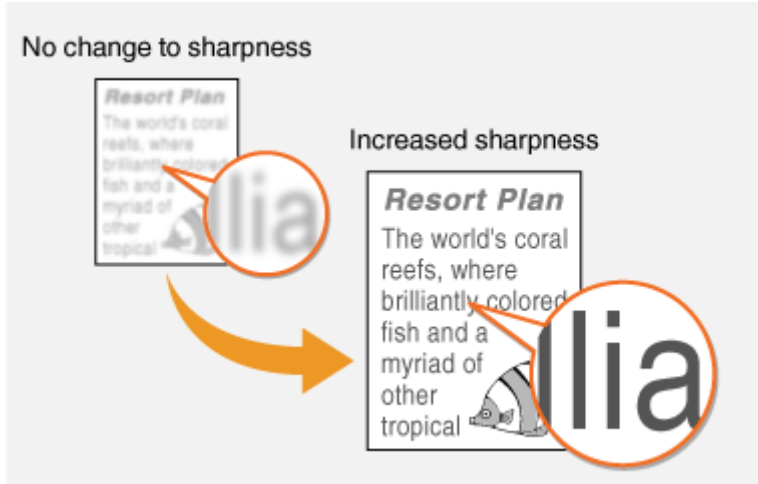

**Example:** If you want to improve the appearance of magazine photos

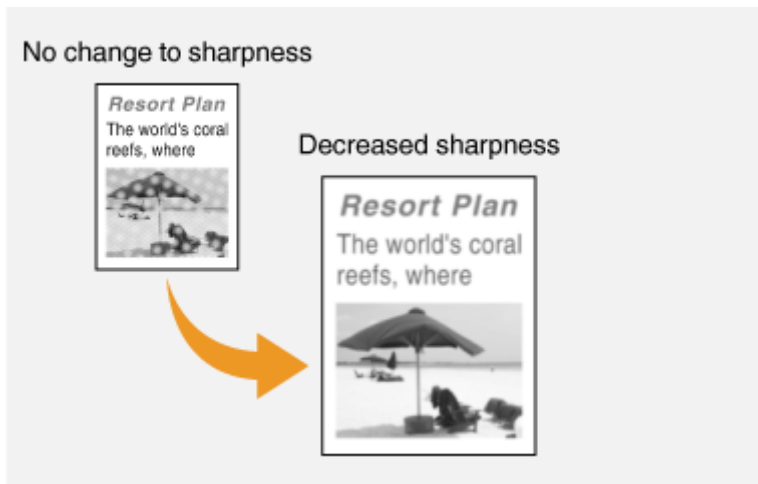

## Scanning 2-Sided Originals



The machine can automatically scan the front and back sides of originals in the feeder.

### IMPORTANT

- The machine cannot scan both sides of originals automatically when the originals are placed on the platen glass or when the machine is set to Manual Sending.



Select <2-Sided Original> in the <TX/RX Settings> tab ► Select <Book Type> or <Calendar Type>

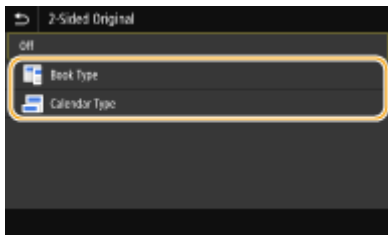

#### <Book Type>

Select for originals whose images on the front and back sides face the same direction.

#### <Calendar Type>

Select for originals whose images on the front and back sides face in opposite directions.

## 6 Select <Start>.

- If the <Confirm Destination> screen is displayed, check whether the destination is correct, and then select <Start Scanning>.

► Scanning of the original starts.

- If you want to cancel, select <Cancel> ► <Yes>. [▶Canceling Sending Faxes\(P. 222\)](#)

### ■When placing originals in the feeder in step 1

When scanning is complete, the faxes are sent.

### ■When placing originals on the platen glass in step 1

When scanning is complete, follow the procedure below.

- 1 Select the original size.
  - When there is only one page to be scanned, proceed to step 3.
- 2 Place the next original on the platen glass, and select <Scan Next>.
  - Repeat this step until you finish scanning all of the pages.
- 3 Select <Start Sending>.

► The faxes are sent.

## TIPS

- If you always want to send faxes with the same settings: [▶Changing the Default Settings for Functions\(P. 170\)](#)
- If you want to register a combination of settings to use when needed: [▶Registering Frequently Used Settings\(P. 168\)](#)
- If you want to sound an alarm when the handset is off the hook: [▶<Off-Hook Alarm>\(P. 523\)](#)

## LINKS

- [▶Canceling Sending Faxes\(P. 222\)](#)

▶ **Useful Functions When Sending(P. 226)**

▶ **Checking Status and Log for Sent and Received Documents(P. 238)**

## Canceling Sending Faxes

261J-04E

If you want to cancel sending faxes immediately after selecting <Start>, select <Cancel> on the display or press  on the operation panel. You can also cancel sending faxes after checking the fax status.

### ■ Select <Cancel> on the screen during fax transmission

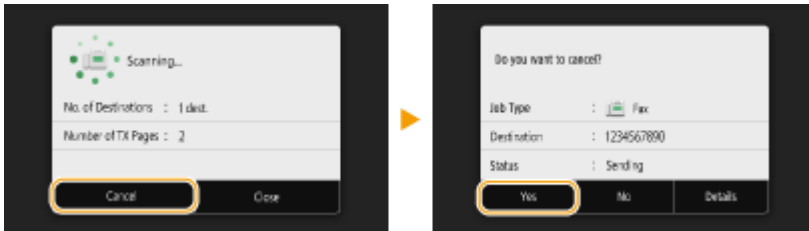

### ■ Press to cancel

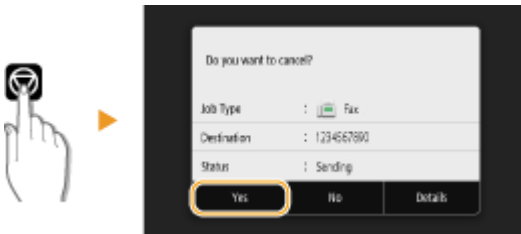

### If the screen displays a list of documents when is pressed

Originals have been scanned and are waiting to be processed. Select the document to cancel, and select <Cancel> ► <Yes>.

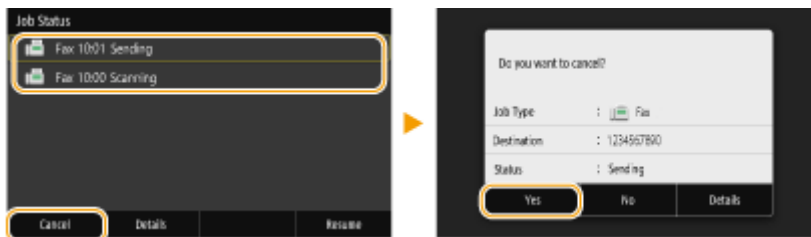

### ■ Check the transmission status before canceling

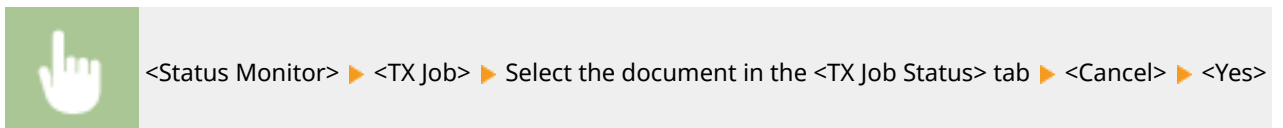

### LINKS

- ▶ **Basic Operations for Sending Faxes(P. 214)**
- ▶ **Checking Status and Log for Sent and Received Documents(P. 238)**

# Receiving Faxes

261J-04F





This section describes the methods for receiving faxes and how to set up the machine to receive faxes. You need to complete some procedures for using fax functions before specifying the receiving settings. **▶Configuring Initial Settings for Fax Functions(P. 79)**



## NOTE

- The machine can print received fax documents on A4 or Letter size paper. If received fax documents are printed on other paper sizes, a portion of the page may not be printed or a page may be printed on two separate sheets of paper.

### ■ Methods for Receiving Faxes

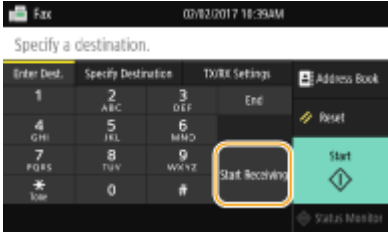
The machine provides the following receiving methods. Select the method that best suits your needs and then set it up by following the procedure in **▶Setting Up the Machine to Receive Faxes(P. 224)** .

<p>&lt;Auto&gt;</p> 	<p><b>Dedicated to receiving faxes</b> The machine receives faxes automatically. Even if someone makes a call to you, you cannot talk to the caller.</p>
<p>&lt;Fax/Tel (Auto Switch)&gt;</p> 	<p><b>When the call is a fax</b> The machine receives the fax automatically.</p> <p><b>When the call is a telephone call</b> An incoming call rings. Pick up the handset to answer the call.</p> <p><b>NOTE:</b></p> <ul style="list-style-type: none"> <li>• You need to connect your telephone or the optional handset to the machine beforehand.</li> </ul>
<p>&lt;Manual&gt;</p> 	<p><b>When the call is a fax</b> An incoming call rings. Pick up the handset. If you hear a beep, select  ▶ &lt;Fax&gt; ▶ &lt;Start Receiving&gt; to receive faxes.</p>  <p><b>When the call is a telephone call</b> An incoming call rings. Pick up the handset. If you do not hear a beep, start your conversation.</p> <p><b>NOTE:</b></p> <ul style="list-style-type: none"> <li>• You need to connect your telephone or the optional handset to the machine beforehand.</li> </ul>

	<ul style="list-style-type: none"> <li>You can set the machine to automatically receive faxes when an incoming call rings within a specified timeframe. ▶&lt;Switch to Auto RX&gt;(P. 532)</li> </ul>
<p>&lt;Answering Machine&gt;</p> 	<p><b>When the call is a fax</b> After an incoming call rings, the machine receives the fax automatically.</p> <p><b>When the call is a telephone call</b> The answering machine activates, enabling the caller to leave a message. If you pick up the handset before the answering machine starts recording a message, you can talk with the caller.</p> <p><b>NOTE:</b></p> <ul style="list-style-type: none"> <li>You need to connect your answering machine to the machine beforehand.</li> <li>Set the answering machine to answer after a few rings.</li> <li>We recommend that you add approximately 4 seconds of silence at the beginning of the message or set the maximum recording time to 20 seconds.</li> </ul>
<p>&lt;Net Switch&gt;</p> 	<p>The machine distinguishes between fax and telephone calls. This mode is only available for certain countries and requires a subscription to a network switch service.</p> <p><b>NOTE:</b></p> <ul style="list-style-type: none"> <li>You need to connect your telephone or the optional handset to the machine beforehand.</li> </ul>

## NOTE

- Depending on the type of telephone connected to it, the machine may not be able to send or receive faxes properly.
- If you are connecting an external telephone with fax functions, set the telephone to not receive faxes automatically.
- If you pick up the telephone handset and hear a beep, the call is a fax. You can receive the fax just by using the telephone to enter a specific ID number. ▶<Using a Telephone to Receive Faxes (Remote Reception)> (P. 225)

### ■ Setting Up the Machine to Receive Faxes

#### 1 Select <Fax> in the Home screen. ▶<Home Screen>(P. 121)

- If the login screen appears, specify the user name, the password, and the authentication server. ▶<Logging in to Authorized Send>(P. 132)

#### 2 Select <RX Mode> in the <TX/RX Settings> tab of the Fax Basic Features screen. ▶<Fax Basic Features Screen>(P. 213)

#### 3 Select the receiving method.

##### ■<When selecting <Fax/Tel (Auto Switch)>

Specify the following three settings as necessary. When the setting is complete, select <Apply>.



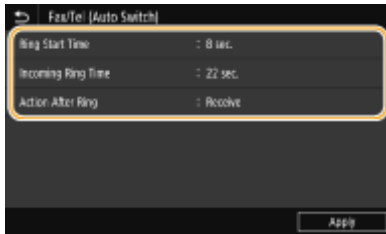

#### <Ring Start Time>

Enables you to specify the duration during which the machine determines whether an incoming call is a fax or a telephone call.

#### <Incoming Ring Time>

Enables you to specify the duration during which an incoming call rings for a telephone call.

#### <Action After Ring>

Enables you to specify how the machine operates if you do not pick up the handset while an incoming call is ringing. Select <End> to disconnect the call or <Receive> to receive an incoming fax.

## TIPS

- If you want to print received documents on both sides of paper: [▶<Print on Both Sides>\(P. 531\)](#)
- If you want to print information, such as reception date and time, at the bottom of received documents: [▶<Print RX Page Footer>\(P. 534\)](#)
- If you want to continue printing even when the amount remaining in the toner cartridge is low: [▶<Continue Print. When Cart. Low>\(P. 530\)](#)

### ■ Using a Telephone to Receive Faxes (Remote Reception)

When you pick up the telephone and get a fax signal, you do not need to go to the machine to receive the fax. Just enter a specific ID number with the telephone, and you can start receiving the fax.

## NOTE

- When the telephone is not directly connected with the machine, the remote reception function is not available.

**1 When an incoming call rings, pick up the telephone handset.**

**2 If you hear a beep, enter the ID number for Remote Reception with the telephone.**

- For more information about setting the ID number, see [▶<Remote RX>\(P. 532\)](#) .

**3 Hang up the handset.**

## LINKS

- [▶Checking Status and Log for Sent and Received Documents\(P. 238\)](#)
- [▶Various Receiving Methods\(P. 233\)](#)

## Useful Functions When Sending

---

261J-04H

This section describes how to forward a fax again to a previously specified destination, how to send a fax after a phone call, and how to save a copy of a fax document.



▶ **Recalling Previously Used Settings for Sending (Recall Settings)(P. 227)**



▶ **Sending a Fax after a Phone Call (Manual Sending)(P. 230)**

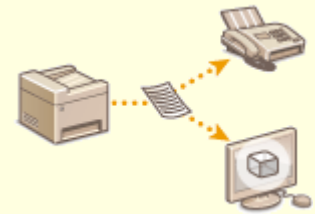

▶ **Saving a Copy of a Sent Original(P. 232)**

# Recalling Previously Used Settings for Sending (Recall Settings)

261J-04J



You can recall the destinations specified in the past. When you specify a previously used destination, the machine also sets the same fax settings such as density you used the last time you sent documents to that destination.

## IMPORTANT

- When <Restrict Resending from Log> is set to <On>, you cannot use this feature. ▶ **Disabling Use of Previously Used Destinations(P. 403)**
- Turning OFF the machine or setting <Restrict New Destinations> to <On> deletes the past destinations, and disables this feature. ▶ **Restricting New Destinations that Can Be Specified(P. 403)**
- The destinations in Manual Sending are not available for this feature. ▶ **Sending a Fax after a Phone Call (Manual Sending)(P. 230)**

## NOTE

- When you specify a destination using this feature, any destinations that you have already specified are deleted.

### 1 Place the original(s). ▶ **Placing Originals(P. 134)**

### 2 Select <Fax> in the Home screen. ▶ **Home Screen(P. 121)**

- If the login screen appears, specify the user name, the password, and the authentication server. ▶ **Logging in to Authorized Send(P. 132)**

### 3 Select <Reset> in the Fax Basic Features screen. ▶ **Fax Basic Features Screen(P. 213)**

- If the destinations set by the previous user are still selected, this can cause transmission errors. Always reset the settings before sending.

### 4 Select <Recall Settings> in the <Specify Destination> tab.

### 5 Select the destination.

- When you transmit to multiple destinations, only the address specified for the first transmission is displayed in the log, but all the destinations are specified.

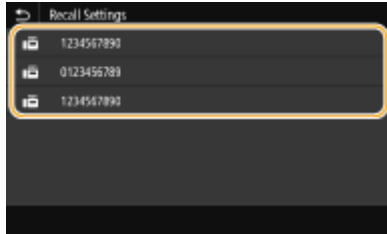

⇒ The selected destination and the fax settings used at the time are specified. You can also change the settings before sending.

**■ To delete destinations**

When you transmitted to multiple destinations, you can delete destinations as necessary.

- 1 Select <Confirm Destination>.
- 2 Select the check box for the destination to be deleted, and select <Remove from Dest.>.

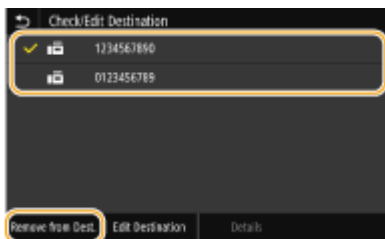

**NOTE:**

- If you select the Group Dial check box, you can view the destinations registered in the group by selecting <Details> ► <Destination>.

- 3 Select <Yes>.

**6 Specify the scanning settings as necessary. ◀ Basic Operations for Sending Faxes(P. 214)**

**7 Select <Start>.**

- If the <Confirm Destination> screen is displayed, check whether the destination is correct, and then select <Start Scanning>.

⇒ Scanning of the original starts.

- If you want to cancel, select <Cancel> ► <Yes>. ▶ **Canceling Sending Faxes(P. 222)**

**■ When placing originals in the feeder in step 1**

When scanning is complete, the faxes are sent.

**■ When placing originals on the platen glass in step 1**

When scanning is complete, follow the procedure below.

- 1 Select the original size.
  - When there is only one page to be scanned, proceed to step 3.
- 2 Place the next original on the platen glass, and select <Scan Next>.
  - Repeat this step until you finish scanning all of the pages.

**3** Select <Start Sending>.

▣▣▣▣ The faxes are sent.

## LINKS

---

🔗 **Basic Operations for Sending Faxes(P. 214)**

## Sending a Fax after a Phone Call (Manual Sending)

261J-04K



You can send faxes manually at the end of a phone conversation. When you hear a beep over the phone, it means the recipient is trying to receive your faxes. Select <Start> to send your faxes.

### NOTE

- You need to connect your telephone or the optional handset to the machine beforehand.

### 1 Place the original(s). ▶ [Placing Originals\(P. 134\)](#)

- The machine cannot automatically scan both sides of the originals in Manual Sending.
- When the original is placed on the platen glass, only one page can be sent.

### 2 Select <Fax> in the Home screen. ▶ [Home Screen\(P. 121\)](#)

- If the login screen appears, specify the user name, the password, and the authentication server. ▶ [Logging in to Authorized Send\(P. 132\)](#)

### 3 Select <Reset> in the Fax Basic Features screen. ▶ [Fax Basic Features Screen\(P. 213\)](#)

- If the destinations set by the previous user are still selected, this can cause transmission errors. Always reset the settings before sending.

### 4 Specify the scanning settings as necessary. ▶ [Basic Operations for Sending Faxes\(P. 214\)](#)

### 5 Dial the recipient's fax number.

### 6 Ask the recipient to set their fax machine to receive your faxes.

- If you hear a beep, proceed to step 7.

### 7 Select <Start>.

- If you place the original on the platen glass, select the original size.
  - ▶ Scanning of the original starts.
    - If you want to cancel, select <Cancel> ▶ <Yes>. ▶ [Canceling Sending Faxes\(P. 222\)](#)

### 8 Hang up the handset.

## LINKS

---

- ▶ **Basic Operations for Sending Faxes(P. 214)**
- ▶ **Canceling Sending Faxes(P. 222)**
- ▶ **Checking Status and Log for Sent and Received Documents(P. 238)**

## Saving a Copy of a Sent Original

261J-04L

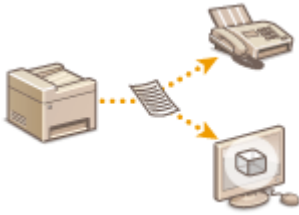

In addition to the address specified when the fax is sent, you can also send faxed documents to a preset storage address for archiving. This is useful for keeping a log of what has been sent. You can specify a fax number, an e-mail address, a shared folder on the computer, an FTP server or an I-Fax as the storage address.

### NOTE

- Only destinations in the Address Book can be specified as a storage address. To use the Address Book, the destination must be registered beforehand. **▶ Registering Destinations(P. 176)**



<Menu> ▶ <Function Settings> ▶ <Send> ▶ <Fax Settings> ▶ <Archive TX Document> ▶ Select <On> and select <Archive Address> ▶ Select the check box for the target archive destination in the Address Book, and select <Apply> ▶ <Apply> ▶ 



## Various Receiving Methods

---

261J-04R

You can store received faxes in the machine's memory without printing them. You can reduce fax paper waste by checking the detailed information of fax documents and only printing necessary documents.

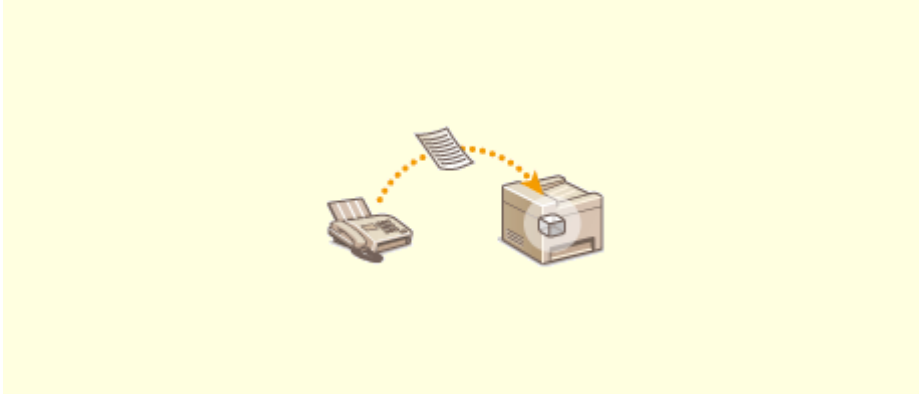

▶ **Saving Received Documents into the Machine (Memory Reception)(P. 234)**

# Saving Received Documents into the Machine (Memory Reception)

261J-04S





You can store received faxes into memory of the machine, and then print them later. This feature can prevent unauthorized persons from seeing confidential documents unintentionally.

- ▶ **Storing Documents into Memory(P. 234)**
- ▶ **Printing Documents in Memory(P. 235)**
- ▶ **Checking/Forwarding/Deleting Documents in Memory(P. 235)**

## Storing Documents into Memory

To store received documents into memory, set <Use Memory Lock> to <On>. You can configure a setting to enable you to preview received documents using the Remote UI. You can also specify a setting to activate the Memory Reception function only during a specified period of time of the day.



<Menu> ▶ <Function Settings> ▶ <Receive/Forward> ▶ <Common Settings> ▶ <Set Fax/I-Fax Inbox> ▶ <Fax Memory Lock Settings> ▶ Select <On> in <Use Memory Lock> ▶ Specify each setting ▶ <Apply> ▶ 

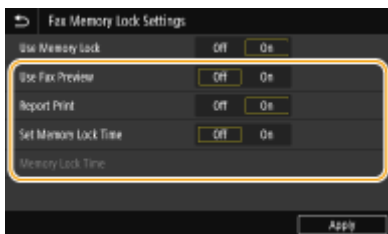

### <Use Fax Preview>

Specify whether to preview received documents stored in memory. Select <On> to preview the documents using the Remote UI. ▶ **Checking Current Status of Received Documents(P. 419)**

### <Report Print>

Enables you to print RX Result reports every time documents are stored into memory. To print reports, select <On>. You also need to set <RX Result Report> to <On>. ▶ **RX Result Report(P. 583)**

### <Set Memory Lock Time>

Specify whether to activate the Memory Reception function only during a specific time frame of the day. Select <On> to activate the Memory Reception function only during a time frame specified in <Memory Lock Time>.

### <Memory Lock Time>

Set the time to start and end the Memory Reception function.

## NOTE

- You cannot specify <Use Fax Preview> and <Set Memory Lock Time> at the same time.

## Printing Documents in Memory

To print received documents in memory, set <Use Memory Lock> to <Off>. All the documents in memory are printed.

### NOTE

- You cannot select a specific document for printing.
- If a time for the feature to deactivate has been specified, the documents are automatically printed at the specified time.



<Menu> ▶ <Function Settings> ▶ <Receive/Forward> ▶ <Common Settings> ▶ <Set Fax/I-Fax Inbox> ▶ <Fax Memory Lock Settings> ▶ Select <Off> in <Use Memory Lock> ▶ <Apply> ▶

## Checking/Forwarding/Deleting Documents in Memory

You can check an outline of each document stored in memory, including sender fax numbers and number of pages sent. You can also select and forward a document stored in memory, and delete an unnecessary document, if any.

- 1** Select <Status Monitor>.
- 2** Select <RX Job>.
- 3** In the <RX Job Status> tab, select the document you want to check/forward/delete.

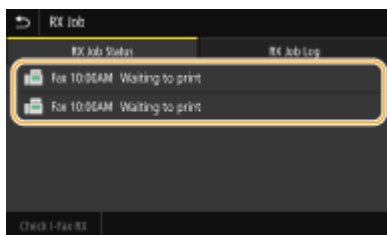

☰ Displays detailed information about the document.

- To forward the document, select <Forward>, and specify the appropriate destination.
- To delete the document, select <Delete> ▶ <Yes>.

### LINKS

- ▶ [Receiving Faxes\(P. 223\)](#)
- ▶ [Checking Status and Log for Sent and Received Documents\(P. 238\)](#)

# Forwarding the Received Documents Automatically

261J-04U

The machine can forward all the received documents to specified destinations. Even if you are out of the office, you can receive fax information anytime, anywhere.

- 🔍 **Specifying Settings for Documents to be Forwarded Automatically(P. 236)**
- 🔍 **Printing Documents to be Forwarded(P. 236)**
- 🔍 **Printing/Resending/Deleting Documents that Failed to be Forwarded(P. 236)**

## Specifying Settings for Documents to be Forwarded Automatically

While the Forwarding feature is activated, all the documents to be received are automatically forwarded.



<Menu> ▶ <Function Settings> ▶ <Receive/Forward> ▶ <Fax Settings> ▶ <Forwarding Settings> ▶ <Forwarding Function> ▶ Select <On> in <Use Forwarding Function> ▶ <Forwarding Destination> ▶ Select the check box for the target forwarding destination in the Address Book, and select <Apply> ▶ <Apply> ▶ 

## Printing Documents to be Forwarded

If you want to check the documents to be forwarded for yourself, you can set the machine to print the documents whenever they are forwarded, or to print only the documents that failed to be forwarded.





<Menu> ▶ <Function Settings> ▶ <Receive/Forward> ▶ <Fax Settings> ▶ <Forwarding Settings> ▶ <Print Images> ▶ Select <On> or <Only When Error Occurs> ▶ 

## Printing/Resending/Deleting Documents that Failed to be Forwarded

You can store documents that failed to be forwarded in memory, and print, resend, or delete them later.

### ■ Storing Documents that Failed to be Forwarded in Memory



<Menu> ▶ <Function Settings> ▶ <Receive/Forward> ▶ <Fax Settings> ▶ <Forwarding Settings> ▶ <Store Images in Memory> ▶ <Only When Error Occurs> ▶ 

### ■ Printing/Resending/Deleting Documents Stored in Memory

- 1** Select <Status Monitor>.

**2** Select <Fax Forwarding Errors>.

**3** Select the document you want to print/resend/delete.

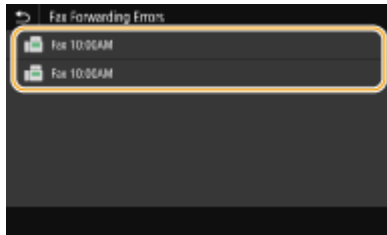

⇒ Displays detailed information about the document.

- To print the document, select <Print> ► <Yes>.
- To resend the document, select <Forward>, select the check box for the target destination, and then select <Apply>.
- To delete the document, select <Delete> ► <Yes>.

## NOTE

- You can use the Remote UI to preview the documents that failed to be forwarded. **▶ Checking Information of Documents That Failed To Be Forwarded(P. 419)**

## LINKS

---

**▶ Receiving Faxes(P. 223)**

**▶ Checking Status and Log for Sent and Received Documents(P. 238)**

# Checking Status and Log for Sent and Received Documents

261J-04W

The statuses and communication logs for sent and received fax and I-Fax documents can be checked separately for sending and receiving.

## IMPORTANT

- When <Display Job Log> is set to <Off>, you cannot check the communication logs. ▶<Display Job Log>(P. 547)

**1** Select <Status Monitor>.

**2** Select <TX Job> or <RX Job>.

**3** Check the statuses and communication logs for sent and received documents.

### ■ To check the statuses for sent and received documents

**1** Select the document whose status you want to check in the <TX Job Status> or <RX Job Status> tab.

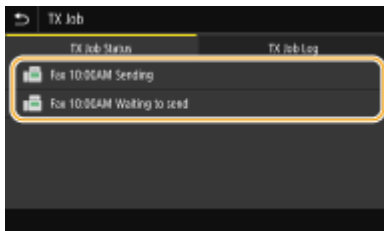

▢ Displays detailed information about the document.

- If you specified multiple destinations, the number of specified destinations is displayed on the screen. To check the details of specified multiple destinations, select <Destination>.

### ■ To check the communication logs for sent and received documents

**1** Select the document whose log you want to check in the <TX Job Log> or <RX Job Log> tab.

- <OK> is displayed when a document was sent or received successfully, and <Error> is displayed when a document failed to be sent or received because it was canceled or there was some error.

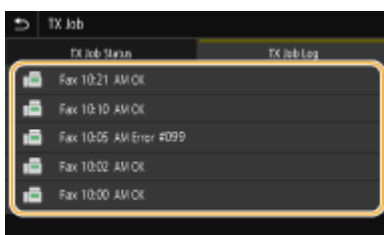

▢ Displays detailed information about the document.

## NOTE:

When a three-digit number is shown in the case of <Error>

- This number represents an error code. [▶Countermeasures for Each Error Code\(P. 632\)](#)

## LINKS

---

- [▶Basic Operations for Sending Faxes\(P. 214\)](#)
- [▶Canceling Sending Faxes\(P. 222\)](#)
- [▶Receiving Faxes\(P. 223\)](#)
- [▶Sending I-Faxes\(P. 244\)](#)
- [▶Receiving I-Faxes\(P. 251\)](#)
- [▶Printing Reports and Lists\(P. 581\)](#)

## Sending Faxes from Your Computer (PC Fax)

261J-04X

You can send fax documents created on your computer application directly from your computer. This feature eliminates the need to print documents for faxing and saves paper. You need to specify the basic fax settings ( [▶ Configuring Initial Settings for Fax Functions\(P. 79\)](#) ) and install the fax driver on your computer. For more information about how to install the fax driver, see the manuals for the relevant drivers on the online manual website.



### ▶ Sending PC Faxes(P. 241)

## NOTE

- Depending on the operating system and the version of the fax driver you are using, the fax driver screens in this manual may differ from your screens.

### About the Fax Driver Help

- Clicking [Help] on the fax driver screen displays the Help screen. On this screen you can see information that is not in the User's Guide, including information about driver features such as registering frequently used settings and how to set up those features.



# Sending PC Faxes

261J-04Y

## IMPORTANT

- When <Allow Fax Driver TX> is set to <Off> on the machine, you cannot send faxes from computers. ▶  
**Restricting Fax Sending from a Computer(P. 405)**
- You need to enable Department ID Management on the fax driver you are using if Department ID Management is enabled on the machine. For more information, click [Help] on the fax driver screen. ▶  
**Setting the Department ID Management(P. 351)**

### 1 Open a document in an application and display the print dialog box.

- How to display the print dialog box differs for each application. For more information, see the instruction manual for the application you are using.

### 2 Select the fax driver for this machine, and click [Print].

### 3 Specify the destination.

#### ■ To specify only one destination

- 1 Click the [Enter Destination] tab.
- 2 Set the communication mode and fax number (or URI).

The screenshot shows the 'Fax Sending Settings' dialog box with the 'Enter Destination' tab selected. A yellow box highlights the 'Communication Mode' dropdown (set to G3), the 'Fax Number/URI' dropdown (set to Fax Number), and the 'Fax Number' text box (containing 98765432). Below these fields are 'Confine Fax Number', 'Destination Name', 'Use Subaddress' (checkbox), and 'Subaddress' text boxes.

#### ■ To specify multiple destinations at once

- 1 Click the [Select Destination] tab.
- 2 Click [Add Destination].
- 3 Set the communication mode and fax number (or URI), and click [OK].

#### 4 Repeat steps 2 and 3 to add concurrent destinations.

- You can also add a destination by clicking [Add Next Destination] in step 3.

- If you need to specify a number to dial an outside line, select [Detailed Settings] ► [Add Outside Dialing Prefix to G3/G4/IP Fax Number] and enter the number in [Outside Dialing Prefix]. The specified number is added to the beginning of the fax number when the machine dials.
- To make it easier to specify destinations using the Address Book.
- Selecting [Store Sent Fax Information and Image] enables you to store the logs for sending documents and check detailed information of a sent document along with its image, including destinations and number of pages. For more information, click [Help] on the fax driver screen.

### NOTE:

- When the [Confirm Fax Number] or [Confirm URI] field is active, also enter the appropriate number in the field. The setting of whether to confirm entered numbers can be changed in the fax driver screen. For more information, click [Help] on the fax driver screen.

#### 4 Click [Send] to send the document.

### LINKS

---

- [When Printing or Sending from the Windows Store App\(P. 705\)](#)

## Using Internet Fax (I-Fax)

---

261J-050

The Internet Fax (I-Fax) function allows you to send and receive faxes over the Internet. Originals are sent attached as TIFF images files to e-mail. Since a telephone connection is not used, you can send faxes to distant locations and send documents with many pages without worrying about communications charges. Some advance preparation is required, such as specifying the mail server settings. **▶ Procedure for Setting to Send E-Mail/Send and Receive I-Fax(P. 86)**



- ▶ Sending I-Faxes(P. 244)
- ▶ Receiving I-Faxes(P. 251)

# Sending I-Faxes

261J-051

To send a fax to a computer or another I-Fax-compatible device, specify an e-mail address instead of a fax number as the destination. If you send an I-Fax to a computer, it is sent as an e-mail attachment in TIFF format. And in the same way as when you send e-mail to a computer, you can specify multiple destinations and specify Cc and Bcc destinations.

## 1 Place the original(s). ▶ **Placing Originals(P. 134)**

## 2 Select <Scan> in the Home screen. ▶ **Home Screen(P. 121)**

- If the login screen appears, specify the user name, the password, and the authentication server. ▶ **Logging in to Authorized Send(P. 132)**

## 3 Select <I-Fax> in the Scan Basic Features screen. ▶ **Scan Basic Features Screen(P. 276)**

## 4 Specify the destination.

- ▶ Specifying from Address Book
- ▶ Specifying from Coded Dial Numbers
- ▶ Entering Destinations Directly
- ▶ Specifying Destinations in an LDAP Server

### Specifying from Address Book



The Address Book enables you to specify a destination by selecting from a list of registered destinations or by searching by name for destinations with recipient names.

### NOTE

- You need to register destinations in the Address Book before using this feature. ▶ **Registering Destinations(P. 176)**

## 1 Select <Address Book> in the <Specify Destination> tab.

## 2 Select <To>.

## 3 Select an index. ▶ **Index(P. 176)**

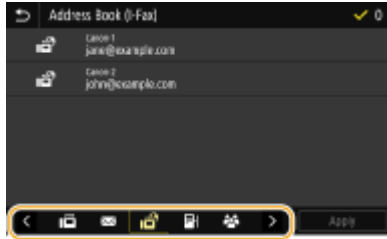

**4** Select the check box for the desired destination, and select <Apply>.

## TIPS

- If a destination is selected from <Address Book> in the Home screen, the Basic Features screen for I-Fax sending can be displayed while the selected destination remains being specified.

## Specifying from Coded Dial Numbers



Three-digit numbers (coded dial numbers) are assigned to addresses in the Address Book. You can specify an address simply by entering its coded dial number.

## NOTE

- To use coded dial numbers, the destination must be registered in the Address Book beforehand. ▶ **Registering Destinations(P. 176)**

**1** Select <Coded Dial> in the <Specify Destination> tab.

**2** Select <To>.

**3** Enter a three-digit number.

- If you have entered an incorrect value, use **C** to clear it.

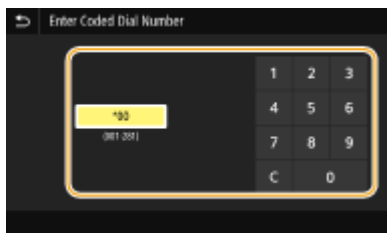

## NOTE:

If a confirmation screen appears

- When <Confirm When Coded Dial TX> is set to <On>, a screen is displayed that shows the destination and the name for the number. (For Group Dial, the destination name and the number of destinations are shown.) Check the contents and if everything is correct, select <OK>. To specify a different destination, select <Cancel> and then re-enter the three-digit coded dial number. **▶Displaying Destinations in Address Book(P. 403)**

## Entering Destinations Directly

For a destination that is not registered in the Address Book, specify it by entering an I-Fax address.

**1 Select <Use Keyboard> in the <Specify Destination> tab.**

**2 Enter the I-Fax address, and select <Apply>.**

- On how to enter text, see **▶Entering Text(P. 130)** .

## Specifying Destinations in an LDAP Server



If your office has an LDAP server installed, you can specify a destination using user information in the server. Access the LDAP server via the machine to search for the appropriate user information and specify it as destination.

### NOTE

- You need to specify the settings for connecting to an LDAP server beforehand. **▶Registering LDAP Servers(P. 64)**

**1 Select <LDAP Server> in the <Specify Destination> tab.**

**2 Select the LDAP server you are using.**

**3 Select conditions for user information to be searched.**

- Name, fax numbers, e-mail addresses, organization names, and organization unit are available criteria for searching destinations.

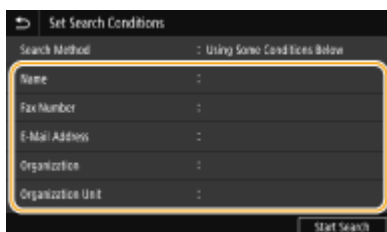

#### 4 Enter the search target character string, and select <Apply>.

- On how to enter text, see [▶Entering Text\(P. 130\)](#) .
- To specify multiple search criteria, repeat steps 3 and 4.

#### 5 Select <Search Method>.

#### 6 Select conditions to display the search result.

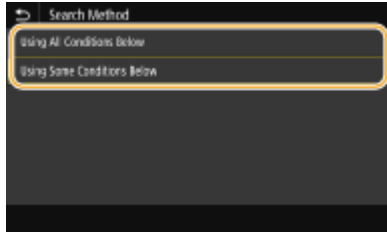

##### <Using All Conditions Below>

Searches and displays the users that meet all the search criteria specified in steps 3 and 4.

##### <Using Some Conditions Below>

If users that meet even one of the criteria specified in steps 3 and 4 are found, displays all those users.

#### 7 Select <Start Search>.

⇒ The users meeting your search criteria are displayed.

#### NOTE:

- If the authentication screen appears when you select <Start Search>, enter the user name of the machine and the password registered in the LDAP server, and select <Apply>. [▶Registering LDAP Servers\(P. 64\)](#)

#### 8 Select the check box for the user that you want to specify as destination, and select <Apply>.

#### NOTE:

##### If a screen on which a destination is already specified appears

- You can only send to your own e-mail address. To send to other destinations, you must configure the send function authentication settings so that e-mail transmission is not restricted. Contact your administrator for details. [▶LDAP Server Authentication\(P. 359\)](#) .

##### Specifying destinations from the transmission records

- You can also recall previously used destinations. [▶Recalling Previously Used Settings for Sending/ Saving \(Recall Settings\)\(P. 308\)](#)

#### 5 Specify multiple destinations, including Cc/Bcc destinations, as necessary.

- Select the method used to specify destinations in the <Specify Destination> tab, and then specify the destination.

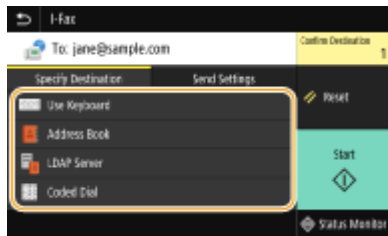

- If you selected <LDAP Server> or <Specify Myself as Destination>, the destination is specified in the <To> field.
- <Cc> and <Bcc> addresses can only be selected using <Address Book> or <Coded Dial>.

### ■ To delete destinations

If you specified multiple destinations, you can delete destinations as necessary.

- 1 Select <Confirm Destination>.
- 2 Select the check box for the destination to be deleted, and select <Remove from Dest.>.
  - If you select the Group check box, you can view the destinations registered in the group by selecting <Details> ► <Destination>.
- 3 Select <Yes>.

## 6 Specify the scanning settings as necessary.

- For more information about each setting, see [▶ Sending Data by E-Mail/Saving Data to a Shared Folder or FTP Server\(P. 286\)](#) or [▶ Scanning Clearly\(P. 298\)](#) .

## 7 Specify the subject, message, and reply-to address for the e-mail as necessary.

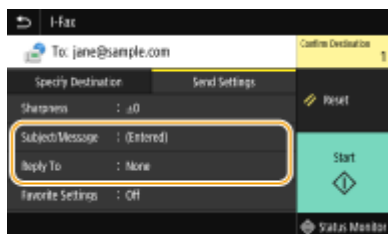

### ■ To specify subject/message

- 1 Select <Subject/Message> in the <Send Settings> tab.
- 2 Select <Subject>
- 3 Enter the subject, and select <Apply>.
- 4 Select <Message>.
- 5 Enter the message, and select <Apply>.
- 6 Select <Apply>.

### ■ To specify reply-to address

Specify the reply-to address when you want to notify the recipient of an e-mail address different from that of the machine as the reply-to address. Select the target reply-to address from the destinations registered in the



Address Book, and specify it. If the destination has not been registered in the Address Book, see [Registering Destinations\(P. 176\)](#) .

- 1 Select <Reply To> in the <Send Settings> tab.
- 2 Select <Specify from Address Book>.
- 3 Select the check box for the desired reply-to address, and select <Apply>.

### NOTE:

- The reply-to address that can be specified is always one of the e-mail addresses registered in the Address Book.

## 8 Select <Start>.

- If the <Confirm Destination> screen is displayed, check whether the destination is correct, and then select <Start Scanning>.
  - ▣ Scanning of the original starts.
    - If you want to cancel, select <Cancel> ► <Yes>. [Canceling Sending Faxes\(P. 222\)](#)

### ■ When placing originals in the feeder in step 1

When scanning is complete, the I-Faxes are sent.

### ■ When placing originals on the platen glass in step 1

When scanning is complete, follow the procedure below.

- 1 If there are additional pages of originals to be scanned, place the next original on the platen glass, and select <Scan Next Original>.
  - Repeat this step until you finish scanning all of the pages.
  - When there is only one page to be scanned, proceed to the next step.
- 2 Select <Start Sending>.
  - ▣ The I-Faxes are sent.

### NOTE:

#### If the <SMTP Authentication> screen appears

- Enter the user name and password, and select <Apply>.

### If a Send Error Occurs

Error notifications are sometimes sent to the e-mail address set to the machine. If you leave it as-is, it may result in an insufficient remaining capacity of mailbox depending on your mail server. It is recommended that you clear the mailbox periodically.

### ■ To clear the mailbox

#### IMPORTANT:

- When the mailbox is cleared, all e-mail in the server mailbox is deleted. When you specify the e-mail account that you use usually, you should first check whether any e-mail in the mailbox needs to be kept.

- 1 Start the Remote UI and log in to System Manager Mode. [Starting Remote UI\(P. 415\)](#)

- 2 Click [Settings/Registration] on the Portal page. [▶Remote UI Screen\(P. 416\)](#)
- 3 Select [TX Settings] ▶ [Network Settings - E-Mail/I-Fax Settings].
- 4 Click [Clear] in [Clear Mail Box].
- 5 Read the message that is displayed, and click [OK].  
⇒ E-mail is deleted from the mailbox.

## TIPS

- If you always want to send with the same settings: [▶Changing the Default Settings for Functions\(P. 170\)](#)
- If you want to register a combination of settings to use when needed: [▶Registering Frequently Used Settings\(P. 168\)](#)
- If you want to specify the I-Fax sender name: [▶<Register Unit Name>\(P. 518\)](#)

## LINKS

---

- ▶[Checking Status and Log for Sent and Received Documents\(P. 238\)](#)

## Receiving I-Faxes

261J-052

### ■ When an I-Fax Arrives

When an I-Fax arrives, the Data indicator on the operation panel blinks. After the I-Fax is completely received, the document is printed out automatically and the indicator goes out.

### NOTE

- To cancel reception, select <Status Monitor> ▶ <RX Job> ▶ select a document in the <RX Job Status> tab ▶ <Delete> ▶ <Yes>.

### ■ Receiving I-Faxes Manually

If you want to connect to the server before receiving I-Faxes automatically, or if you want to configure the machine so that it does not receive I-Faxes automatically, use the method below to receive I-Faxes manually. If there is a document on the server, printing begins.



<Status Monitor> ▶ <RX Job> ▶ <Check I-Fax RX>

### ■ Printout Paper

Regardless of the received document size, incoming I-Faxes are printed at the size specified in <RX Print Size>. ▶<RX Print Size>(P. 530)

### NOTE

- If paper of the size specified in <RX Print Size> is not loaded in the paper drawer, the <No Paper> error message is displayed. ▶<Countermeasures for Each Message>(P. 618)

### TIPS

- If you want to print received documents on both sides of paper: ▶<Print on Both Sides>(P. 530)
- If you want to continue printing even when the amount remaining in the toner cartridge is low: ▶<Continue Print. When Cart. Low>(P. 530)

### LINKS

▶<Checking Status and Log for Sent and Received Documents>(P. 238)

# Printing

<b>Printing</b> .....	253
<b>Printing from a Computer</b> .....	254
Canceling Prints .....	256
Checking the Printing Status and Log .....	258
<b>Various Printing Methods</b> .....	260
Printing a Document Secured by a PIN (Secure Print) .....	261
Printing via Secure Print .....	262
Printing from a USB Memory Device (Memory Media Print) .....	265

# Printing

There are many ways to use the machine as a printer. You can print documents on your computer by using the printer driver or print image files from a USB memory device. Make full use of the print functions to suit your needs.

## ■ Printing from a Computer

You can print a document made on your computer by using the printer driver.

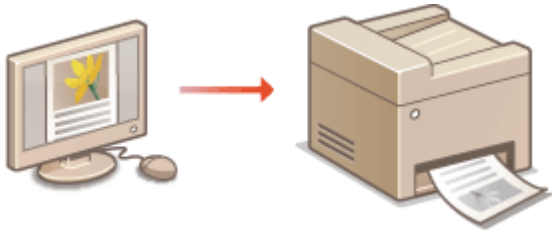

▶ **Printing from a Computer(P. 254)**

## ■ Useful Functions When Printing

You can assign a PIN to the print data to enhance security or directly print files stored in a USB memory device.



▶ **Various Printing Methods(P. 260)**

### Printing from Mobile Devices

- Linking mobile devices such as smartphones or tablets to this machine provides a quick and easy way to print photos and web pages. The machine also supports Google Cloud Print™.
  - ▶ **Linking with Mobile Devices(P. 319)**
  - ▶ **Using Google Cloud Print(P. 341)**

# Printing from a Computer

261J-054

You can print a document made with an application on your computer by using the printer driver. There are useful settings on the printer driver, such as enlarging/reducing and 2-sided printing, that enable you to print your documents in various ways. Before you can use this function, you need to complete some procedures, such as installing the printer driver on your computer. For more information, see the manuals for the relevant drivers on the online manual website.

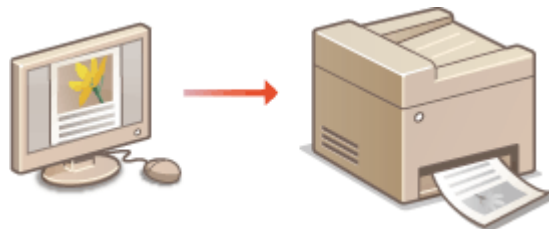

- ▶ **About the Printer Driver Help(P. 254)**
- ▶ **To Use the Optional Items(P. 254)**
- ▶ **Basic Printing Operations(P. 254)**

## About the Printer Driver Help

Clicking [Help] on the printer driver screen displays the Help screen. On this screen, you can see the detailed descriptions that are not in the User's Guide.

## To Use the Optional Items

If the optional paper feeder is attached to the machine after installation of the printer driver, perform the following operation on the printer driver.

### IMPORTANT

- To perform the following procedure, log in to your computer with an administrator account.



Open the printer folder ( ▶ **Displaying the Printer Folder(P. 698)** ) ▶ Right-click the printer driver icon for this machine ▶ [Printer Properties] or [Properties] ▶ [Device Settings] tab ▶ [Paper Source] ▶ Select the paper feeder from [1-Cassette Feeding Unit] to [3-Cassette Feeding Unit] in [Optional Drawer/Cassette] ▶ [OK] ▶ [OK]

## Basic Printing Operations

This section describes how to print a document on your computer by using the printer driver.

### NOTE

#### Paper settings on the machine

- Normally, it is necessary to specify the paper size and type for the paper loaded in each paper source before proceeding to printing.

- By setting <Prioritize Driver Settings When Printing> to <On>, you can print from the paper source specified in the printer driver, regardless of the paper settings on the machine. ▶<Prioritize Driver Settings When Printing>(P. 492)

- 1 Open a document in an application and display the print dialog box.
- 2 Select the printer driver for this machine, and click [Preferences] or [Properties].
- 3 Specify the print settings as necessary, and click [OK].
  - Switch the tab according to the settings.

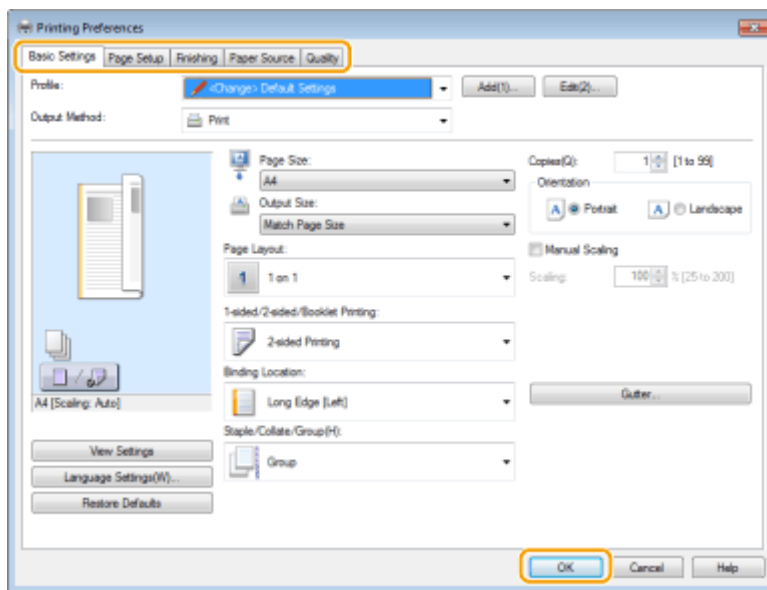

#### 4 Click [Print] or [OK].

⇒ Printing starts.

- If you want to cancel printing, see ▶<Canceling Prints(P. 256) .

## LINKS

- ▶<Checking the Printing Status and Log(P. 258)
- ▶<When Printing or Sending from the Windows Store App(P. 705)

# Canceling Prints

261J-055

You can cancel printing from your computer or on the operation panel of the machine.

- ▶ From a Computer(P. 256)
- ▶ From the Operation Panel(P. 257)

## From a Computer

You can cancel printing from the printer icon displayed on the system tray on the desktop.

### 1 Double-click the printer icon.



#### NOTE:

When the printer icon is not displayed

- Open the printer folder ( ▶ **Displaying the Printer Folder(P. 698)** ), right-click the printer driver icon for this machine, and click [See what's printing] (or double-click the icon of the printer driver for this machine).

### 2 Select the document you want to cancel, and click [Document] ▶ [Cancel].

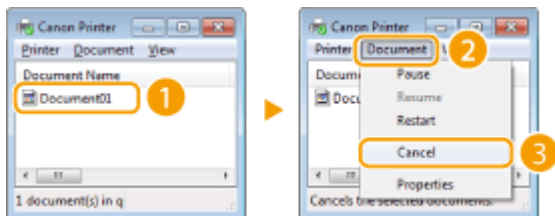

### 3 Click [Yes].

⇒ Printing of the selected document is canceled.

## NOTE

- Several pages may be output after you cancel printing.

## TIPS

### Canceling from the Remote UI

- You can cancel printing from the [Job Status] page on the Remote UI: ▶ **Checking Current Status of Print Documents(P. 418)**

### Canceling from an application

- On some applications, a screen like shown below appears. You can cancel printing by clicking [Cancel].



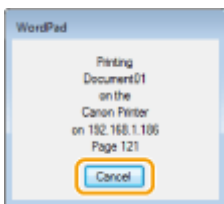

## From the Operation Panel

Cancel printing using  or <Status Monitor>.

### ■ Press to Cancel

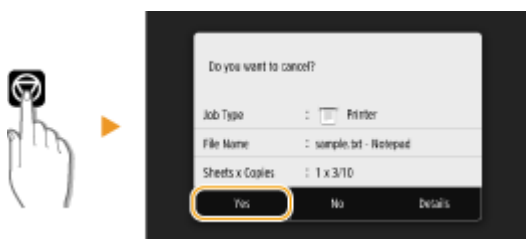

### If the Screen Displays a List of Documents When is Pressed

Select the document you want to cancel, and select <Cancel> ► <Yes>.



### ■ Check the Print Job Status Before Canceling



<Status Monitor> ► <Copy/Print Job> ► Select the document in the <Copy/Print Job Status> tab  
 ► <Cancel> ► <Yes>

## NOTE

- Several pages may be output after you cancel printing.

## LINKS

- ▶ **Basic Printing Operations(P. 254)**
- ▶ **Checking the Printing Status and Log(P. 258)**

# Checking the Printing Status and Log

261J-056

You can check the current print statuses and the logs for printed documents.

## IMPORTANT

- When <Display Job Log> is set to <Off>, you cannot check the print logs. **▶<Display Job Log>(P. 547)**

### Useful in the Following Cases

- When your documents are not printed for a long time, you may want to see the waiting list of the documents waiting to be printed.
- When you cannot find your printouts that you thought had been printed, you may want to see whether an error has occurred.

**1** Select <Status Monitor>.

**2** Select <Copy/Print Job>.

**3** Check the print statuses and logs.

#### ■To check the print statuses

- 1** Select the document whose status you want to check in the <Copy/Print Job Status> tab.

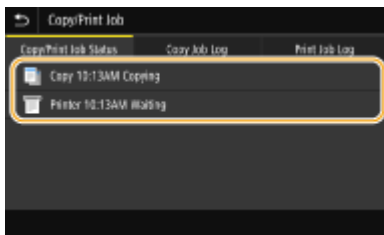

▢▢▢▢ Displays detailed information about the document.

#### ■To check the print logs

- 1** Select the document whose log you want to check in the <Print Job Log> tab.
- <OK> is displayed when a document was printed successfully, and <Error> is displayed when a document failed to be printed because it was canceled or there was some error.

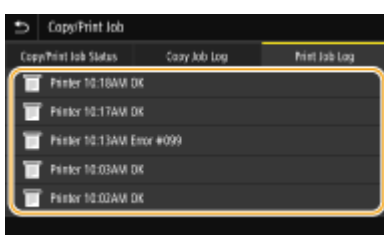

▣▣▣ Displays detailed information about the document.

- The displayed document name or user name may not reflect the actual document or user name.

## NOTE:

When a three-digit number is shown in the case of <Error>

- This number represents an error code. ▶ **Countermeasures for Each Error Code(P. 632)**

## LINKS

---

▶ **Basic Printing Operations(P. 254)**

▶ **Canceling Prints(P. 256)**

## Various Printing Methods

---

261J-057

This section describes how to print a document by adding a PIN, and how to print a file stored on a USB memory device without using the printer driver.



▶ **Printing a Document Secured by a PIN (Secure Print)(P. 261)**

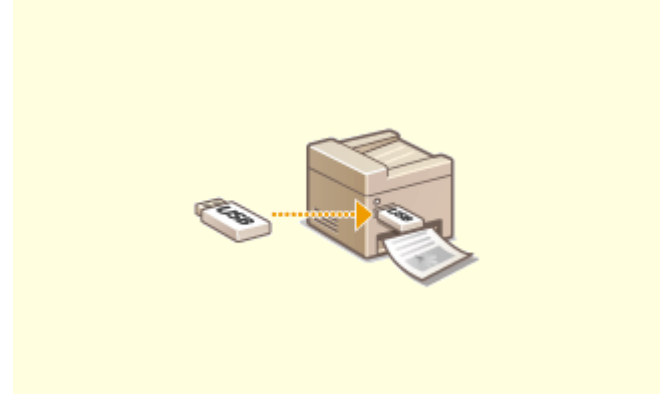

▶ **Printing from a USB Memory Device (Memory Media Print)(P. 265)**

## Printing a Document Secured by a PIN (Secure Print)

261J-058

By setting a PIN to a document when printing from a computer, the document is held in the memory of the machine, and is not printed until the correct PIN is entered on the operation panel of the machine. This function is called "Secure Print," and the document that is protected by a PIN is called a "secured document." Using Secure Print keeps printouts of confidential documents from being left unattended.

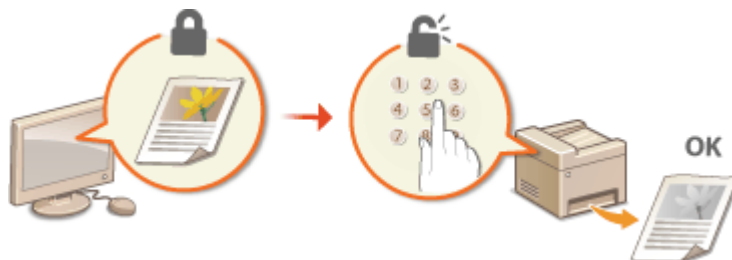

▶ **Printing via Secure Print(P. 262)**

# Printing via Secure Print

261J-059

This section describes how to print a document from an application as a secured document. The first part of this section describes how to send a secured document to the machine, and the second part of this section describes how to print the secured document on the machine.

- ▶ **Sending a Secured Document from a Computer to the Machine(P. 262)**
- ▶ **Printing Out Secured Documents(P. 263)**
- ▶ **Changing the Valid Time Period for Secured Documents(P. 264)**

## Sending a Secured Document from a Computer to the Machine

- 1** Open a document in an application and display the print dialog box.
- 2** Select the printer driver for this machine, and click [Preferences] or [Properties].
- 3** Select [Secured Print] in [Output Method].
  - ▶▶ The [Information] pop-up screen is displayed. Check the message, and click [Yes] or [No].
- 4** Specify the print settings as necessary, and click [OK].
  - Switch the tab according to the settings.

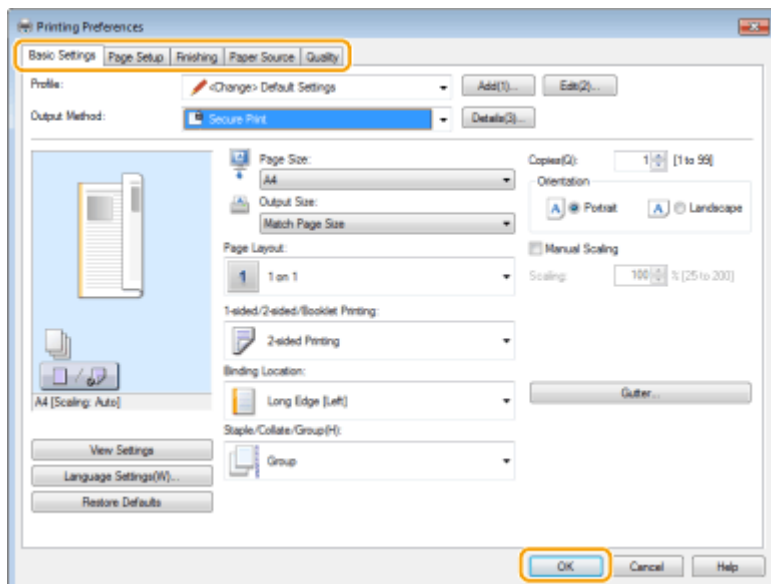

- 5** Click [Print] or [OK].

▶▶ After the secured document is sent to the machine, it is held in the memory of the machine waiting to be printed.

## Printing Out Secured Documents

Prints secured documents sent to the machine. After a valid time period ( **▶ Changing the Valid Time Period for Secured Documents(P. 264)** ) has elapsed, the secured document will be deleted from the memory of the machine and can no longer be printed.

### NOTE

- If secured documents are left unprinted, they occupy the memory and may prevent the machine from printing even ordinary (not secured) documents. Make sure that you print your secured documents as soon as you can.
- You can check how much memory is being used for secured documents.  
<Status Monitor> ▶ <Device Information> ▶ <Secure Print Memory Usage>

### 1 Select <Secure Print> in the Home screen. **▶ Home Screen(P. 121)**

#### NOTE:

- You cannot proceed to the next step if the <Remote Scanner> screen shown below is displayed. In this case, select  to close the screen, and select <Secure Print>.

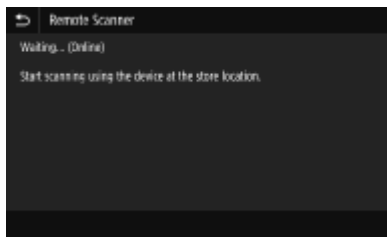

### 2 Select the check box for the secured document to print, and select <Start>.

- You can select multiple documents that have the same PIN.

#### NOTE:

##### If a screen for user selection is displayed

- If secured documents from two or more users are stored in memory, the screen for user selection is displayed prior to the screen for file selection. Select your user name.

##### Deleting a secured document

- You can collectively delete multiple documents. Select the check box for the secured document to delete, and select <Delete>.

### 3 Enter the PIN, and select <Apply>.

- When you select multiple documents with different PINs in step 2, a message is displayed. Select <Close>, and select the secured documents again in step 2.

▢▶ Printing starts.

- If you want to cancel printing, select <Cancel> ▶ <Yes>.

## Changing the Valid Time Period for Secured Documents

You can change the valid time period from the time secured document data is sent to the machine until the time it is deleted within a certain period of time.

**1** Select **<Menu>** in the Home screen. **▶Home Screen(P. 121)**

**2** Select **<Function Settings>**.

**3** Select **<Secure Print>**.

- If the login screen appears, enter the correct ID and PIN. **▶Logging in to the Machine(P. 132)**

**4** Select **<Secure Print Deletion Time>**.

### NOTE:

**When <Secure Print Deletion Time> cannot be selected**

- Set **<Use Secure Print>** to **<On>**.

**Disabling Secure Print**

- Set **<Use Secure Print>** to **<Off>**, and then restart the machine.

**5** Specify how long the machine holds secured documents, and select **<Apply>**.

- The secured document is deleted from the memory of the machine unless it is printed before the time specified here elapses.

**6** Select **<Apply>**.

**7** Select **<OK>**.

**8** Restart the machine.

- Turn OFF the machine, wait for at least 10 seconds, and turn it back ON.

### LINKS

---

**▶Checking the Printing Status and Log(P. 258)**

**▶Restricting Printing from a Computer(P. 407)**



# Printing from a USB Memory Device (Memory Media Print)

261J-05A

You can print files directly by connecting a USB memory device to the machine. Using this function, you can print without using a computer. For more information about the available USB memory devices and how to insert/remove the USB memory device, see [▶Using a USB Memory Device\(P. 184\)](#) .



## IMPORTANT

- It is necessary to set <Use Print Function> to <On>. [▶<Memory Media Settings>\(P. 541\)](#)

**1** Select <Memory Media Print> in the Home screen. [▶Home Screen\(P. 121\)](#)

**2** Select the check box for the file to print.

- You can select multiple files.

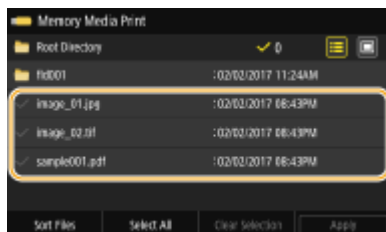

- To clear a selection, select the file you have selected (✓) again.
- Selecting a folder displays its contents. To return to the folder in the upper level, select .

### NOTE:

- Folders and files in a level deeper than the fifth directory are not displayed.
- When you move to another folder, the previous file selections will be cleared.

### ■To select all files

- Select <Select All>.
  - To clear all selections, select <Clear Selection>.
- If file types are mixed, select <JPEG/TIFF Files> or <PDF Files>.

### ■To change the file display method

You can select the file display method from "Preview"/"Details."

**Preview**

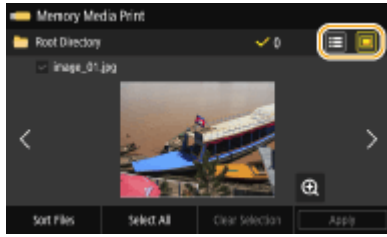

**Details**

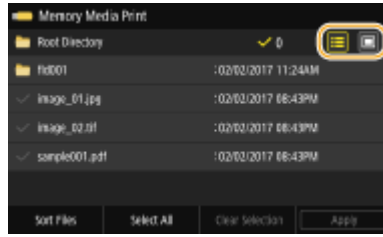

**NOTE:**

- You can specify the file display method used to display the <Memory Media Print> screen. ▶<Default Display Settings>(P. 539)

**■ To change the file sort order**

You can change the sort order of the files in a USB memory device.

**NOTE:**

- You can specify a sort setting such as <Name (Ascending)> or <Date/Time (Ascending)> as the default setting for the file sort order. ▶<File Sort Default Settings>(P. 540)

- 1 Select <Sort Files>.
- 2 Select the criteria for file sorting.

**NOTE:**

- When you select <Date/Time (Ascending)> or <Date/Time (Descending)>, files are sorted based on the modification dates and time of the files.

**3 Select <Apply>.**

**4 Specify the print settings as necessary.**

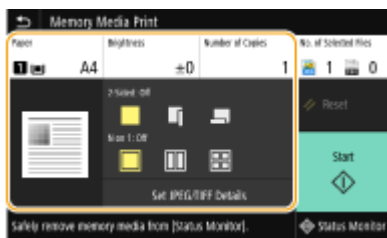

- You can select <Reset> to restore all the default print settings.



**<Paper>**

Select the paper source that contains the paper to use for printing.



	Uses the paper that is loaded in the multi-purpose tray to print files.
	Uses the paper that is loaded in the paper drawer (Drawer 1) of the machine to print files.

**NOTE:**

- When the optional paper feeder is installed, its paper drawer is also displayed.
- When specifying other print settings, select <Close>.

**<Brightness>**

- <Brightness> is not available for printing PDF files.

You can adjust the brightness of images.



**NOTE:**

- When specifying other print settings, select <Close>.

**<Number of Copies>**

Enter the number of copies.



**NOTE:**

- When specifying other print settings, select <Close>.



**<2-Sided Printing>**

You can select 1-sided printing or 2-sided printing.



	Prints on one side of paper.
	Prints on both sides of paper in such a way that the printed pages are opened horizontally when bound.

## Printing

	
	<p>Prints on both sides of paper in such a way that the printed pages are opened vertically when bound.</p> 

### NOTE:





- <2-Sided Printing> may not be available with some sizes or types of paper. ▶ **Available Paper(P. 673)**

### <N on 1>

- <N on 1> is not available for printing TIFF files.

You can select an "N on 1" pattern to print multiple pages of image data on one side of a sheet of paper.



	Does not apply N on 1.
	Prints two pages of image data on one side of a sheet of paper.
	Prints four pages of image data on one side of a sheet of paper.
 (PDF only)	Prints eight pages of image data on one side of a sheet of paper.

### NOTE:

- For a PDF file, you can print 9 or 16 pages of image data on one side of a sheet of paper by using <N on 1> under <Set PDF Details>.

### <Set JPEG/TIFF Details>

You can change the print settings for JPEG and TIFF images.



**<2-Sided Printing>**

You can make 2-sided printouts. Select the binding position.

**<N on 1> (JPEG files only)**

Prints data for multiple pages of image data on the same side of a sheet of paper. You can specify the number of pages to print on one side of a sheet of paper. For example, to print four pages on one side of a sheet of paper, select <4 on 1>.

**<Original Type>**

You can select the type of original depending on the image to print.

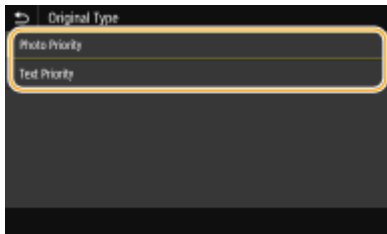

**<Photo Priority>**

Gives priority to printing photo images smoothly.

**<Text Priority>**

Gives priority to printing text clearly.

**<Halftones>**

You can select the printing method used to reproduce halftones (the intermediate range between the lighter and darker areas of an image) for optimal image quality.

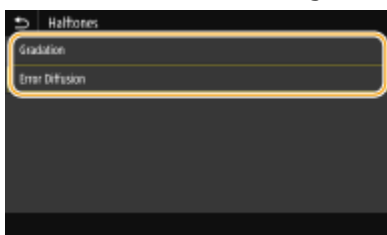

**<Gradation>**

Prints images with fine gradation, such as digital camera images, with a smooth finish.

**<Error Diffusion>**

Prints images with small text or fine lines with a clear finish.

**<Print Quality>**

You can change settings related to print quality.

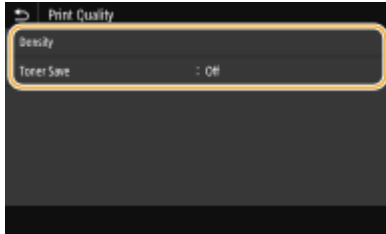

**<Density>**

Adjusts the density for printing.

**<Toner Save>**

Selecting <On> prints in toner saving mode. Select <On> when you want to check the layout or other appearance characteristics before proceeding to final printing of a large job.

**NOTE:**

- When <Toner Save> is set to <On>, <Density> is not available.

**<Set PDF Details>**

You can change the print settings for PDFs.



**<2-Sided Printing>**

You can make 2-sided printouts. Select the binding position.

**<N on 1>**

Prints data for multiple pages of image data on the same side of a sheet of paper. You can specify the number of pages to print on one side of a sheet of paper. For example, to print four pages on one side of a sheet of paper, select <4 on 1>.

**<Print Range>**

Specify pages you want to print.

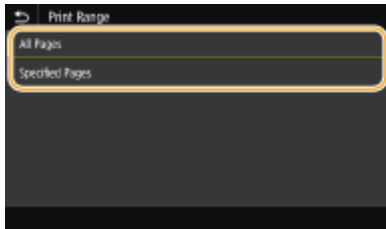

**<All Pages>**

Prints all pages.

**<Specified Pages>**

Specify the range of pages you want to print. Enter the desired value in each of <Start Page> and <End Page>, and select <Apply>.

## IMPORTANT:

- When the specified page range does not match any of the pages of the PDF file, printing is not performed.

### <Enlarge/Reduce to Fit Paper Size>

Specify whether to enlarge or reduce the original according to the print range of paper. Note that size enlargement/reduction will not affect the aspect ratio of the original.

### <Enlarge Print Area>

Specify whether to extend the print range to the paper size.

## NOTE:

- If you set to <On>, part of print data may not be printed in edge areas or paper may be partly smudged depending on the document.

### <Print Comments>

This setting specifies whether to print annotations in the PDF file.

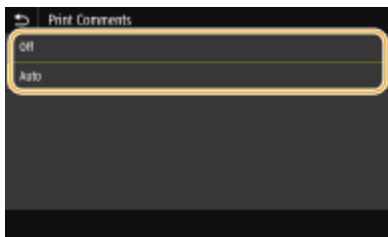

#### <Off>

Prints no annotations.

#### <Auto>

Prints only those annotations that are specified to be printed in the PDF file.

### <Password to Open Document>

You can print password protected PDF files by entering the password required to open them. Enter the password, and select <Apply>.

### <Other Settings>

#### <Halftones>

You can select the printing method used to reproduce halftones (the intermediate range between the lighter and darker areas of an image) for optimal image quality. You can make this setting for each of the types of image contained in one document. See [▶<Halftones>\(P. 511\)](#) for the description of the setting.

#### <Grayscale Conversion>

Specify the way of printing color data in black and white. See [▶<Grayscale Conversion>\(P. 512\)](#) for the description of the setting.

#### <Print Quality>

##### <Density>

Adjust the toner density to be used for printing. See [▶<Density>\(P. 495\)](#) for the description of the setting.

##### <Toner Save>

Selecting <On> prints in toner saving mode. Select <On> when you want to check the layout or other appearance characteristics before proceeding to final printing of a large job. See [▶<Toner Save>\(P. 495\)](#) for the description of the setting.

**<Image Refinement>**

Enable or disable the smoothing mode in which the edges of characters and graphics are smoothly printed. See [▶<Image Refinement>\(P. 495\)](#) for the description of the setting.

**<Resolution>**

Specify the resolution to process print data. See [▶<Resolution>\(P. 496\)](#) for the description of the setting.

**5 Select <Start>.**

▣▶ Printing starts.

- If you want to cancel printing, select <Cancel> ▶ <Yes>.

**TIPS**

- If you always want to print with the same settings: [▶Memory Media Print\(P. 170\)](#)

**LINKS**

---

[▶<Store/Access Files>\(P. 536\)](#)



# Scanning

<b>Scanning</b> .....	274
<b>Scan Basic Features Screen</b> .....	276
<b>Basic Operations for Scanning Originals</b> .....	279
Scanning and Saving to a Computer .....	280
Saving Data to a USB Memory Device .....	282
Sending Data by E-Mail/Saving Data to a Shared Folder or FTP Server .....	286
Canceling Sending Documents .....	295
Checking Status and Log for Scanned Originals .....	296
<b>Scanning Clearly</b> .....	298
Adjusting Image Quality .....	299
Adjusting Density .....	300
Adjusting Sharpness When Scanning (Sharpness) .....	301
<b>Useful Scanning Functions</b> .....	303
Enhancing the Security of Electronic Files .....	304
Adjusting Balance between File Size and Image Quality (Data Size) .....	307
Recalling Previously Used Settings for Sending/Saving (Recall Settings) .....	308
Specifying E-Mail Settings .....	311
<b>Using Your Computer to Scan (Remote Scan)</b> .....	314
Scanning Documents from an Application .....	315
Using ScanGear MF .....	317

# Scanning

261J-05C

You can scan original documents by using the operation panel of the machine or an application on a computer. Whichever way you use, the scanned originals are converted into electronic file formats such as PDFs. Use the scan function to convert large-volume paper documents into files so that you can organize them easily.

## NOTE

- To use this machine as a scanner, you must complete preparations in advance, including installation of software to a computer. For more information, see the manuals for the relevant drivers or software on the online manual website. To connect the machine to your computer via a network, you must register the machine to the installed software. ▶ **Preparing to Use the Machine as a Scanner(P. 85)**
- Depending on the operating system and the version of the scanner driver or applications you are using, the screens in this manual may differ from your screens.

### ■ Using Basic Operations

You can scan and save originals to your computer by using the operation panel of the machine. You can also save originals to a USB memory device or send them as e-mail attachments.

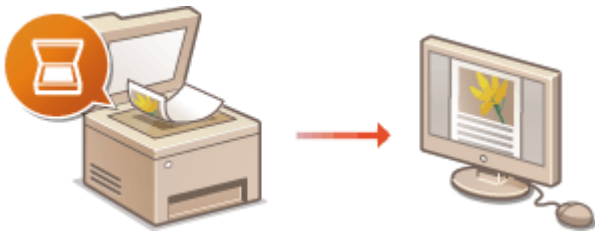

- ▶ **Scan Basic Features Screen(P. 276)**
- ▶ **Basic Operations for Scanning Originals(P. 279)**
- ▶ **Canceling Sending Documents(P. 295)**
- ▶ **Checking Status and Log for Scanned Originals(P. 296)**

### ■ Enhancing Quality

You can find instructions on how to resolve problems such as "blurry photos" or "text unreadable due to too deep color of the paper."

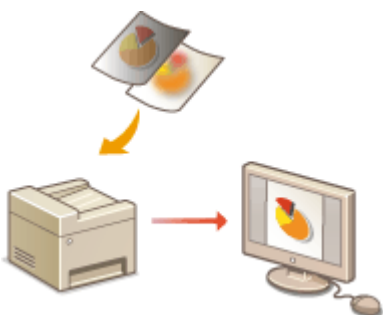

- ▶ **Scanning Clearly(P. 298)**

### ■ Efficiently, Reliably

You can find instructions on how to enhance efficiency when sending data and descriptions of useful settings.

**▶ Useful Scanning Functions(P. 303)****■ Scanning from a Computer**

You can scan originals placed on the machine from a computer. The scanned originals are saved to the computer. You can scan using MF Scan Utility (included with the machine), or with other applications such as an image-processing or word-processing application.

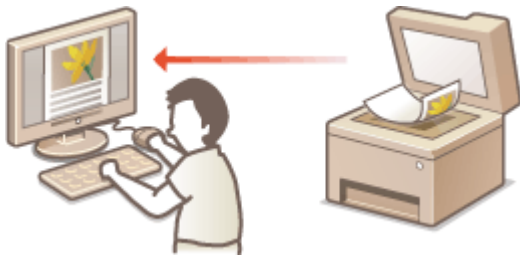
**▶ Using Your Computer to Scan (Remote Scan)(P. 314)****Scanning from Mobile Devices**

- Linking mobile devices such as smartphones or tablets to this machine provides a quick and easy way to scan originals set on this machine. **▶ Linking with Mobile Devices(P. 319)**

## Scan Basic Features Screen

261J-05E

When you select <Scan> in the Home screen, the Scan Basic Features screen appears.

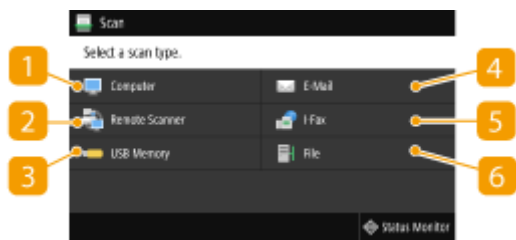

### 1 <Computer>

Saves the scanned data to a computer. ▶ **Basic Features Screen for Computer Scanning(P. 276)**

### 2 <Remote Scanner>

Puts the machine into the online status when originals are scanned from a computer. ▶ **Using Your Computer to Scan (Remote Scan)(P. 314)**

### 3 <USB Memory>

Saves the scanned data to a USB memory device. ▶ **Basic Features Screen for USB Scanning(P. 277)**

### 4 <E-Mail>

Sends the scanned data by e-mail. ▶ **Basic Features Screen for E-Mail Sending/I-Fax Sending/File Saving(P. 277)**

### 5 <I-Fax>

Sends the scanned data by I-Fax. ▶ **Basic Features Screen for E-Mail Sending/I-Fax Sending/File Saving(P. 277)**

### 6 <File>

Saves the scanned data to a shared folder or FTP server. ▶ **Basic Features Screen for E-Mail Sending/I-Fax Sending/File Saving(P. 277)**

## Basic Features Screen for Computer Scanning



### 1 Scan type

Select the scan setting. ▶ **Scanning and Saving to a Computer(P. 280)**

**2 <Start>**

Use this button to start scanning.

**Basic Features Screen for USB Scanning**

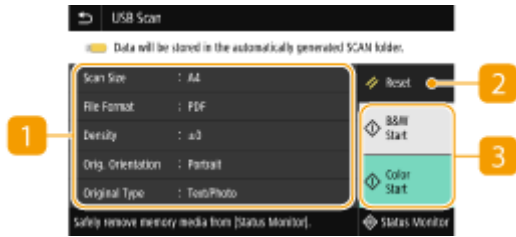

**1 Send Settings**

The original is scanned based on the settings specified here.

**2 <Reset>**

You can collectively restore the default settings.

**3 <Start>**

Use this button to start scanning. Selecting <B&W> starts black and white scanning. Selecting <Color> starts color scanning.

**Basic Features Screen for E-Mail Sending/I-Fax Sending/File Saving**

**E-Mail Sending**



**I-Fax Sending**



**File Saving**

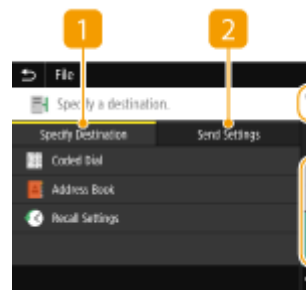

**1 <Specify Destination> tab**

Select this tab to search for a destination in the Address Book or an LDAP server, enter a coded dial, or specify a destination using the recall settings.

- ▶ **Sending Data by E-Mail/Saving Data to a Shared Folder or FTP Server(P. 286)**
- ▶ **Recalling Previously Used Settings for Sending/Saving (Recall Settings)(P. 308)**

**2 <Send Settings> tab**

Select this tab to specify the scanning settings.

**3 <Confirm Destination>**

You can check or change the name and address of the specified destination as well as the number of destinations.

**4 <Reset>**

You can collectively restore the default settings.

**5 <Start>**

Use this button to start scanning. Selecting <B&W> starts black and white scanning. Selecting <Color> starts color scanning.

## Basic Operations for Scanning Originals

---

261J-05F

This section describes the basic procedures for scanning originals.

### ■ Scanning



▶ Scanning and Saving to a Computer(P. 280)



▶ Saving Data to a USB Memory Device(P. 282)



▶ Sending Data by E-Mail/Saving Data to a Shared Folder or FTP Server(P. 286)

### ■ Operating Jobs

- ▶ Canceling Sending Documents(P. 295)
- ▶ Checking Status and Log for Scanned Originals(P. 296)

# Scanning and Saving to a Computer

261J-05H

The sequence of "scanning an original and saving it to a computer" can only be done when scanning from the machine. Scan while specifying what computer originals will be saved to; whether to scan originals in color or black and white; whether to save originals as PDFs or JPEGs; and other settings. Incidentally, if you want to specify a computer connected to the network as the destination, you must register the machine with the computer in advance ( **▶Preparing to Use the Machine as a Scanner(P. 85)** ).

## 1 Place the original(s). **▶Placing Originals(P. 134)**

## 2 Select <Scan> in the Home screen. **▶Home Screen(P. 121)**

- If the login screen appears, specify the user name, the password, and the authentication server. **▶Logging in to Authorized Send(P. 132)**

## 3 Select <Computer> in the Scan Basic Features screen. **▶Scan Basic Features Screen(P. 276)**

- If only a computer connected to the machine via USB is used, proceed to step 5.

## 4 Select the destination computer.

## 5 Select the scan type in the Computer Scan Basic Features screen. **▶Basic Features Screen for Computer Scanning(P. 276)**

- The scan types and settings that are displayed can be confirmed and changed by using MF Scan Utility. For more information, click [Instructions] on MF Scan Utility.

### NOTE:

- If you are a macOS user, see the manuals for the relevant drivers or software on the online manual website.

## 6 Select <Start>.

▣ Scanning of the original starts.

- If you want to cancel, select <Cancel> ▶ <Yes>. **▶Canceling Sending Documents(P. 295)**

### IMPORTANT:

- You cannot scan while the ScanGear MF is displayed. Close the screen before scanning.



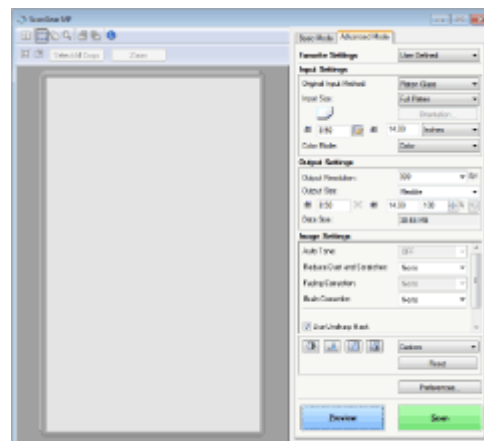

### ■ When placing originals in the feeder in step 1

When scanning is complete, the save destination folder is displayed on the computer.

### ■ When placing originals on the platen glass in step 1

When scanning is complete, follow the procedure below (except if you selected JPEG as a file format).

- 1 If there are additional pages of originals to be scanned, place the next original on the platen glass, and select <Scan Next>.
  - Repeat this step until you finish scanning all of the pages.
  - When there is only one page to be scanned, proceed to the next step.
- 2 Select <Finish>.
  - ▣ The save destination folder is displayed on the computer.

## NOTE

### About the save destination folder

- By default, the scanned data is saved to the My Documents folder. A subfolder named with the scanning date is created, and the data is saved to that folder.
- You can change the save destination from the MF Scan Utility. For more information, click [Instructions] on MF Scan Utility.

## Saving Data to a USB Memory Device

261J-05J

This section describes how to scan the original and save the scanned data to a USB memory device. For more information about the available USB memory devices and how to insert/remove the USB memory device, see **Using a USB Memory Device(P. 184)** .

### IMPORTANT

- It is necessary to set <Use Scan Function> to <On>. **Memory Media Settings>(P. 541)**

#### 1 Place the original(s). **Placing Originals(P. 134)**

#### 2 Select <Scan> in the Home screen. **Home Screen(P. 121)**

- If the login screen appears, specify the user name, the password, and the authentication server. **Logging in to Authorized Send(P. 132)**

#### 3 Select <USB Memory> in the Scan Basic Features screen. **Scan Basic Features Screen(P. 276)**

#### 4 Specify the scanning settings as necessary.

- Specifying the Scanning Size of the Original
- Selecting a File Format
- Specifying Orientation of Your Original
- Scanning 2-Sided Originals

### Specifying the Scanning Size of the Original



You can specify the scanning size of your original.



<Scan Size> ▶ Select the original size

## Selecting a File Format



You can select the file format to which originals are scanned from PDF/JPEG/TIFF. For PDF, you can select Compact PDF that reduces the data size or the PDF format that enables a text search by including text data scanned with OCR (optical character recognition). You can also create a PDF file with enhanced security by encrypting data or adding the signature. **▶ Enhancing the Security of Electronic Files(P. 304)**



<File Format> ▶ Select a file format

### NOTE

- If you select JPEG in <File Format> and try to scan an original from the platen glass, you can only scan one page. To scan a multiple-page original all at once, use the feeder. Each page of the original is saved as a separate file. If you select TIFF or PDF, you can scan multiple-page originals either from the platen glass or from the feeder. In this case, whether the original is to be saved as a single file or each page as a separate file can be specified in **▶ Dividing a PDF File by Page(P. 283)** or **▶ Dividing a TIFF File by Page(P. 283)** .
- <PDF (Compact)> and <PDF (Compact/OCR)> compress photos and illustrations on originals more than <PDF> and <PDF (OCR)>. The file will be smaller, but the image quality of some originals or the number of originals that can be scanned at once may be lower.
- In <PDF (Compact/OCR)> and <PDF (OCR)> you can configure the settings so that the machine automatically detects the original direction during scanning based on the direction of the text read by the OCR function. **▶ <OCR (Text Searchable) Settings>(P. 488)**

### ■ Dividing a PDF File by Page

Specify whether to convert the original with multiple pages into a single PDF file or create a separate PDF file for each page. This setting can be configured for each PDF format.



<File Format> ▶ <Set PDF Details> ▶ Select the PDF format ▶ <Divide into Pages> ▶ Select <Off> or <On>

### ■ Dividing a TIFF File by Page

Specify whether to convert the original with multiple pages into a single TIFF file or create a separate TIFF file for each page.



<File Format> ▶ <Set TIFF Details> ▶ <Divide into Pages> ▶ Select <Off> or <On>

## Specifying Orientation of Your Original



You can specify portrait or landscape orientation.



<Orig. Orientation> ▶ Select the original orientation

## Scanning 2-Sided Originals



The machine can automatically scan the front and back sides of originals in the feeder.

### IMPORTANT

- The machine cannot scan both sides of originals automatically when the originals are placed on the platen glass.



<2-Sided Original> ▶ Select <Book Type> or <Calendar Type>

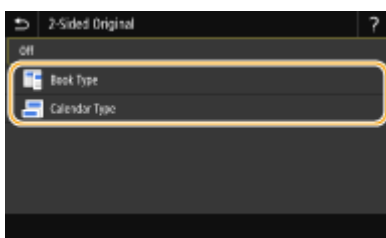

#### <Book Type>

Select for originals whose images on the front and back sides face the same direction.

#### <Calendar Type>

Select for originals whose images on the front and back sides face in opposite directions.

### NOTE:

- For information about other scan settings, see [▶ Scanning Clearly\(P. 298\)](#) or [▶ Adjusting Balance between File Size and Image Quality \(Data Size\)\(P. 307\)](#) .

## 5 Select <Start>.

⇒ Scanning of the original starts.

- If you want to cancel, select <Cancel> ► <Yes>. **▶ Canceling Sending Documents(P. 295)**

### ■ When placing originals in the feeder in step 1

When scanning is complete, the saving process starts.

### ■ When placing originals on the platen glass in step 1

When scanning is complete, follow the procedure below (except if you selected JPEG as a file format).

- 1** If there are additional pages of originals to be scanned, place the next original on the platen glass, and select <Scan Next>.
  - Repeat this step until you finish scanning all of the pages.
  - When there is only one page to be scanned, proceed to the next step.
- 2** Select <Finish>.
  - ▶▶▶ The saving process starts.

### NOTE:

- A new folder is created on the USB memory device, and the scanned document is stored in that folder. The file name of a scanned document is automatically assigned based on the following format: the characters SCAN followed by a four-digit number.file extension name.

## TIPS

- If you always want to scan with the same settings: **▶ Changing the Default Settings for Functions(P. 170)**
- If you want to register a combination of settings to use when needed: **▶ Registering Frequently Used Settings(P. 168)**

# Sending Data by E-Mail/Saving Data to a Shared Folder or FTP Server

261J-05K

This section describes the procedures for scanning originals and sending the scanned data directly from the machine by attaching it to an e-mail or saving it to a shared folder or FTP server.

## NOTE

- Before you can send the data directly by e-mail, you need to complete certain procedures, such as specifying the e-mail server settings. ▶ **Procedure for Setting to Send E-Mail/Send and Receive I-Fax(P. 86)**
- Before you can save the data to a shared folder or FTP server, you need to complete certain procedures, such as specifying the location to save the scanned originals.
  - ▶ **Procedure for Setting a Shared Folder as a Save Location(P. 94)**
  - ▶ **Procedure for Setting a FTP Server as a Save Location(P. 98)**

### 1 Place the original(s). ▶ **Placing Originals(P. 134)**

### 2 Select <Scan> in the Home screen. ▶ **Home Screen(P. 121)**

- If the login screen appears, specify the user name, the password, and the authentication server. ▶ **Logging in to Authorized Send(P. 132)**

### 3 Select <E-Mail> or <File> in the Scan Basic Features screen. ▶ **Scan Basic Features Screen(P. 276)**

### 4 Specify the destination.

- ▶ Specifying from Address Book
- ▶ Specifying from Coded Dial Numbers
- ▶ Entering Destinations Directly (E-Mail Sending)
- ▶ Specifying Destinations in an LDAP Server

## Specifying from Address Book



The Address Book enables you to specify a destination by selecting from a list of registered destinations or by searching by name for destinations with recipient names.

## NOTE

- You need to register destinations in the Address Book before using this feature. ▶ **Registering Destinations(P. 176)**
- Register the shared folder or FTP server address from a computer.
  - ▶ **Setting a Shared Folder as a Save Location(P. 95)**

### ▶ Registering Destinations from Remote UI(P. 427)

- 1 Select <Address Book> in the <Specify Destination> tab.
- 2 Select <To>.
- 3 Select an index. ▶ Index(P. 176)



- 4 Select the check box for the desired destination, and select <Apply>.

## TIPS

- If a destination is selected from <Address Book> in the Home screen, the Basic Features screen for e-mail sending or file saving can be displayed while the selected destination remains being specified.

## Specifying from Coded Dial Numbers



Three-digit numbers (coded dial numbers) are assigned to addresses in the Address Book. You can specify an address simply by entering its coded dial number.

## NOTE

- To use coded dial numbers, the destination must be registered in the Address Book beforehand. ▶ **Registering Destinations(P. 176)**
- Register the shared folder or FTP server address from a computer.
  - ▶ **Setting a Shared Folder as a Save Location(P. 95)**
  - ▶ **Registering Destinations from Remote UI(P. 427)**

- 1 Select <Coded Dial> in the <Specify Destination> tab.
- 2 Select <To>.

### 3 Enter a three-digit number.

- If you have entered an incorrect value, use **C** to clear it.



#### NOTE:

##### If a confirmation screen appears

- When <Confirm When Coded Dial TX> is set to <On>, a screen is displayed that shows the destination and the name for the number. (For Group Dial, the destination name and the number of destinations are shown.) Check the contents and if everything is correct, select <OK>. To specify a different destination, select <Cancel> and then re-enter the three-digit coded dial number. **▶Displaying Destinations in Address Book(P. 403)**

## Entering Destinations Directly (E-Mail Sending)

For a destination that is not registered in the Address Book, specify it by entering an e-mail address.

### 1 Select <Use Keyboard> in the <Specify Destination> tab.

### 2 Enter the e-mail address, and select <Apply>.

- On how to enter text, see **▶Entering Text(P. 130)** .

## Specifying Destinations in an LDAP Server



If your office has an LDAP server installed, you can specify a destination using user information in the server. Access the LDAP server via the machine to search for the appropriate user information and specify it as destination.

#### NOTE

- You need to specify the settings for connecting to an LDAP server beforehand. **▶Registering LDAP Servers(P. 64)**

### 1 Select <LDAP Server> in the <Specify Destination> tab.



## 2 Select the LDAP server you are using.

## 3 Select conditions for user information to be searched.

- Name, fax numbers, e-mail addresses, organization names, and organization unit are available criteria for searching destinations.

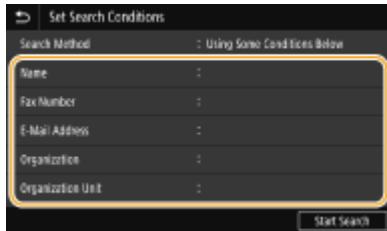

## 4 Enter the search target character string, and select <Apply>.

- On how to enter text, see [▶Entering Text\(P. 130\)](#) .
- To specify multiple search criteria, repeat steps 3 and 4.

## 5 Select <Search Method>.

## 6 Select conditions to display the search result.

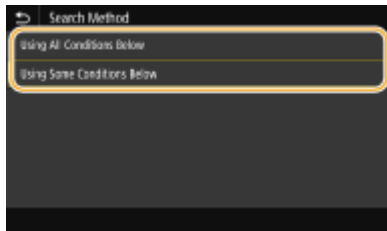

### <Using All Conditions Below>

Searches and displays the users that meet all the search criteria specified in steps 3 and 4.

### <Using Some Conditions Below>

If users that meet even one of the criteria specified in steps 3 and 4 are found, displays all those users.

## 7 Select <Start Search>.

⇒ The users meeting your search criteria are displayed.

### NOTE:

- If the authentication screen appears when you select <Start Search>, enter the user name of the machine and the password registered in the LDAP server, and select <Apply>. [▶Registering LDAP Servers\(P. 64\)](#)

## 8 Select the check box for the user that you want to specify as destination, and select <Apply>.

### NOTE:

### If a screen on which a destination is already specified appears

- You can only send to destinations that are not restricted. To send to other destinations, you must configure the send function authentication settings in such a way that transmission is not restricted. Contact your administrator for details. ▶ **LDAP Server Authentication(P. 359)**

### Specifying destinations from the transmission records

- You can also recall previously used destinations. ▶ **Recalling Previously Used Settings for Sending/ Saving (Recall Settings)(P. 308)**

### Saving the data to a shared folder or FTP server

- Only one destination can be specified.

## 5 When sending an e-mail, specify multiple destinations, including Cc/Bcc destinations, as necessary.

- Select the method used to specify destinations in the <Specify Destination> tab, and then specify the destination.

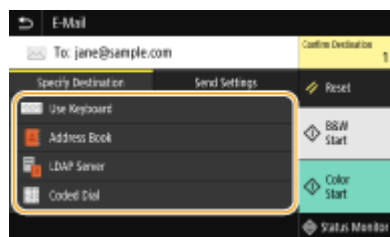

- If you selected <LDAP Server> or <Specify Myself as Destination>, the destination is specified in the <To> field.
- <Cc> and <Bcc> addresses can only be selected using <Address Book> or <Coded Dial>.

### ■ To delete destinations

If you specified multiple destinations, you can delete destinations as necessary.

- Select <Confirm Destination>.
- Select the check box for the destination to be deleted, and select <Remove from Dest.>.
  - If you select Group, select <Details> ▶ <Destination>; you can view the destinations registered in the group.
- Select <Yes>.

## 6 Specify the scanning settings as necessary.

- ▶ Specifying the Scanning Size of the Original
- ▶ Selecting a File Format
- ▶ Specifying Orientation of Your Original
- ▶ Scanning 2-Sided Originals

## Specifying the Scanning Size of the Original



You can specify the scanning size of your original.



Select <Scan Size> in the <Send Settings> tab ▶ Select the original size

## Selecting a File Format



You can select the file format to which originals are scanned from PDF/JPEG/TIFF. For PDF, you can select Compact PDF that reduces the data size or the PDF format that enables a text search by including text data scanned with OCR (optical character recognition). You can also create a PDF file with enhanced security by encrypting data or adding the signature. ▶ **Enhancing the Security of Electronic Files(P. 304)**



Select <File Format> in the <Send Settings> tab ▶ Select a file format

### NOTE

- If you select JPEG in <File Format> and try to scan an original from the platen glass, you can only scan one page. To scan a multiple-page original all at once, use the feeder. Each page of the original is saved as a separate file. If you select TIFF or PDF, you can scan multiple-page originals either from the platen glass or from the feeder. In this case, whether the original is to be saved as a single file or each page as a separate file can be specified in ▶ **Dividing a PDF File by Page(P. 291)** or ▶ **Dividing a TIFF File by Page(P. 292)** .
- <PDF (Compact)> and <PDF (Compact/OCR)> compress photos and illustrations on originals more than <PDF> and <PDF (OCR)>. The file will be smaller, but the image quality of some originals or the number of originals that can be scanned at once may be lower.
- In <PDF (Compact/OCR)> and <PDF (OCR)> you can configure the settings so that the machine automatically detects the original direction during scanning based on the direction of the text read by the OCR function. ▶ **<OCR (Text Searchable) Settings>(P. 488)**

### ■ Dividing a PDF File by Page

Specify whether to convert the original with multiple pages into a single PDF file or create a separate PDF file for each page. This setting can be configured for each PDF format.



Select <File Format> in the <Send Settings> tab ► <Set PDF Details> ► Select the PDF format ► <Divide into Pages> ► Select <Off> or <On>

## ■ Dividing a TIFF File by Page

Specify whether to convert the original with multiple pages into a single TIFF file or create a separate TIFF file for each page.



Select <File Format> in the <Send Settings> tab ► <Set TIFF Details> ► <Divide into Pages> ► Select <Off> or <On>

## Specifying Orientation of Your Original



You can specify portrait or landscape orientation.



Select <Orig. Orientation> in the <Send Settings> tab ► Select the original orientation

## Scanning 2-Sided Originals



The machine can automatically scan the front and back sides of originals in the feeder.

## IMPORTANT

- The machine cannot scan both sides of originals automatically when the originals are placed on the platen glass.



Select <2-Sided Original> in the <Send Settings> tab ► Select <Book Type> or <Calendar Type>

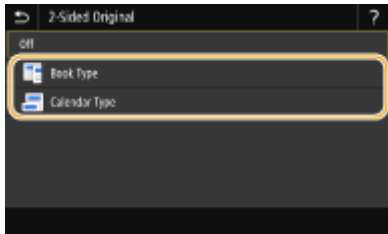

### <Book Type>

Select for originals whose images on the front and back sides face the same direction.

### <Calendar Type>

Select for originals whose images on the front and back sides face in opposite directions.

## NOTE:

- For information about other scan settings, see **▶Scanning Clearly(P. 298)** or **▶Adjusting Balance between File Size and Image Quality (Data Size)(P. 307)** .
- For e-mail, you can specify the subject, message, reply-to address, and priority as necessary. **▶Specifying E-Mail Settings(P. 311)**

## 7 Select <Start>.

- If the <Confirm Destination> screen is displayed, check whether the destination is correct, and then select <Start Scanning>.

⇒ Scanning of the original starts.

- If you want to cancel, select <Cancel> ▶ <Yes>. **▶Canceling Sending Documents(P. 295)**

### ■When placing originals in the feeder in step 1

When scanning is complete, the sending/saving process starts.

### ■When placing originals on the platen glass in step 1

When scanning is complete, follow the procedure below (except if you selected JPEG as a file format).

- 1 If there are additional pages of originals to be scanned, place the next original on the platen glass, and select <Scan Next Original>.
  - Repeat this step until you finish scanning all of the pages.
  - When there is only one page to be scanned, proceed to the next step.

- 2 Select <Start Sending>.

⇒ The sending/saving process starts.

## NOTE:

### If the <File Authentication> or <SMTP Authentication> screen appears

- Enter the user name and password, and select <Apply>.

### File name of the sent document

- The file name of a sent document is automatically assigned based on the following format: communication management number (four digits)\_sent date and time\_document number (three digits).file extension name.

## If an E-Mail Send Error Occurs

---

Error notifications are sometimes sent to the e-mail address set to the machine. If you leave it as-is, it may result in an insufficient remaining capacity of mailbox depending on your mail server. It is recommended that you clear the mailbox periodically.

### ■ To clear the mailbox

#### IMPORTANT:

- When the mailbox is cleared, all e-mail in the server mailbox is deleted. When you specify the e-mail account that you use usually, you should first check whether any e-mail in the mailbox needs to be kept.

- 1 Start the Remote UI and log in to System Manager Mode. [▶ Starting Remote UI\(P. 415\)](#)
- 2 Click [Settings/Registration] on the Portal page. [▶ Remote UI Screen\(P. 416\)](#)
- 3 Select [TX Settings] ▶ [Network Settings - E-Mail/I-Fax Settings].
- 4 Click [Clear] in [Clear Mail Box].
- 5 Read the message that is displayed, and click [OK].

⇒ E-mail is deleted from the mailbox.

## TIPS

- If you always want to scan with the same settings: [▶ Changing the Default Settings for Functions\(P. 170\)](#)
- If you want to register a combination of settings to use when needed: [▶ Registering Frequently Used Settings\(P. 168\)](#)

## Canceling Sending Documents

261J-05L

If you want to cancel sending documents immediately after selecting <Start>, select <Cancel> on the display or press . You can also cancel sending documents after checking the sending status.

### ■ Select <Cancel> to cancel

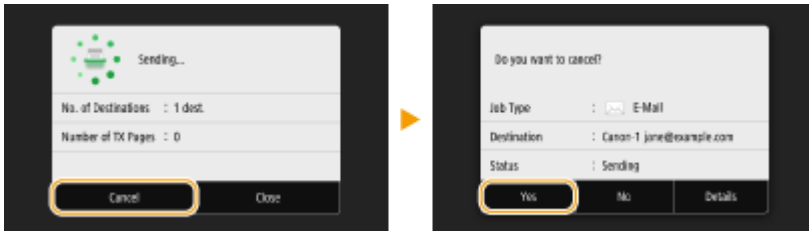

### ■ Press to cancel

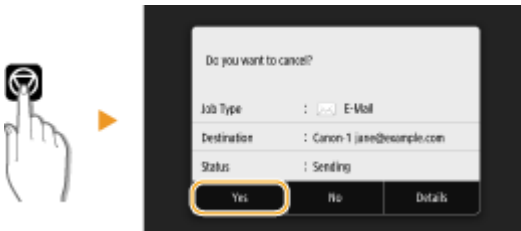

### If the screen displays a list of documents when is pressed

Originals have been scanned and are waiting to be processed. Select the document to cancel, and select <Cancel> ► <Yes>.



### ■ Check the transmission status before canceling

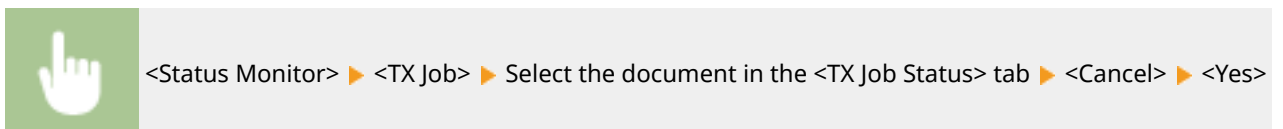

## LINKS

- ▶ Basic Operations for Scanning Originals(P. 279)
- ▶ Checking Status and Log for Scanned Originals(P. 296)

# Checking Status and Log for Scanned Originals

261J-05R

You can check the status and log for scanned originals sent directly from the machine.

## IMPORTANT

- When <Display Job Log> is set to <Off>, you cannot check the logs for sent documents. ▶<Display Job Log>(P. 547)

- 1 Select <Status Monitor>.
- 2 Select <TX Job>.
- 3 Check the statuses and logs for sent documents.

### ■To check the statuses for sent documents

- 1 Select the document whose status you want to check in the <TX Job Status> tab.

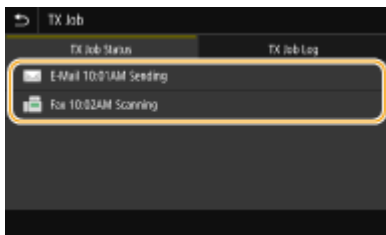

☰ Displays detailed information about the document.

- If you specified multiple destinations, the number of specified destinations is displayed on the screen. To check the details of specified multiple destinations, select <Destination>.

### ■To check the logs for sent documents

- 1 Select the document whose log you want to check in the <TX Job Log> tab.
  - <OK> is displayed when a document was sent successfully, and <Error> is displayed when a document failed to be sent because it was canceled or there was some error.

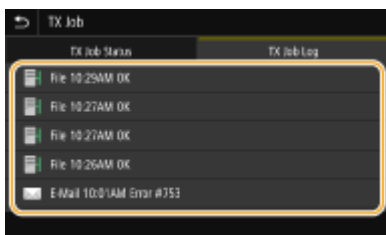

☰ Displays detailed information about the document.

## NOTE:

When a three-digit number is shown in the case of <Error>



- This number represents an error code. ▶ **Countermeasures for Each Error Code(P. 632)**

## LINKS

---

- ▶ **Basic Operations for Scanning Originals(P. 279)**
- ▶ **Canceling Sending Documents(P. 295)**
- ▶ **Printing Reports and Lists(P. 581)**

## Scanning Clearly

---

261J-05S

When creating files for brochures that contain many pictures or reports written in pencil, you can adjust density and brightness to achieve clearer image quality.



▶ Adjusting Image Quality(P. 299)



▶ Adjusting Density(P. 300)

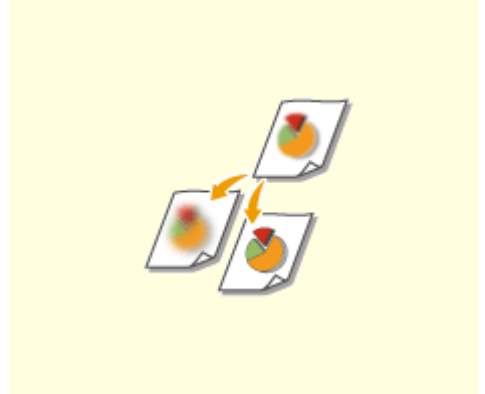

▶ Adjusting Sharpness When Scanning (Sharpness)(P. 301)

## Adjusting Image Quality

261J-05U



You can select the image quality for the scan depending on the original type, such as text-only originals, originals with charts and graphs, or magazine photos.

### Saving Data to a USB Memory Device



<Scan> ▶ <USB Memory> ▶ <Original Type> ▶ Select the original type

### Sending Data by E-Mail/I-Fax or Saving Data to the Server



<Scan> ▶ Specify destinations in <E-Mail>/<I-Fax>/<File> ▶ Select <Original Type> in the <Send Settings> tab ▶ Select the original type

### LINKS

- ▶ [Basic Operations for Scanning Originals\(P. 279\)](#)
- ▶ [Sending I-Faxes\(P. 244\)](#)

## Adjusting Density

261J-05W



You can adjust the density of the scan if the text or images in a original are too light or dark.

### Saving Data to a USB Memory Device



<Scan> ▶ <USB Memory> ▶ <Density> ▶ Adjust the density ▶ <Apply>

### Sending Data by E-Mail/I-Fax or Saving Data to the Server



<Scan> ▶ Specify destinations in <E-Mail>/<I-Fax>/<File> ▶ Select <Density> in the <Send Settings> tab ▶ Adjust the density ▶ <Apply>

### LINKS

- ▶ [Basic Operations for Scanning Originals\(P. 279\)](#)
- ▶ [Sending I-Faxes\(P. 244\)](#)
- ▶ [Adjusting Sharpness When Scanning \(Sharpness\)\(P. 301\)](#)

## Adjusting Sharpness When Scanning (Sharpness)

261J-05X



You can adjust the sharpness of the image. Increase the sharpness to sharpen blurred text and lines, or decrease the sharpness to improve the appearance of magazine photos.

### Saving Data to a USB Memory Device



<Scan> ► <USB Memory> ► <Sharpness> ► Adjust the sharpness ► <Apply>

### Sending Data by E-Mail/I-Fax or Saving Data to the Server



<Scan> ► Specify destinations in <E-Mail>/<I-Fax>/<File> ► Select <Sharpness> in the <Send Settings> tab ► Adjust the sharpness ► <Apply>

**Example:** If you want to sharpen text and lines written in pencil



**Example:** If you want to improve the appearance of magazine photos

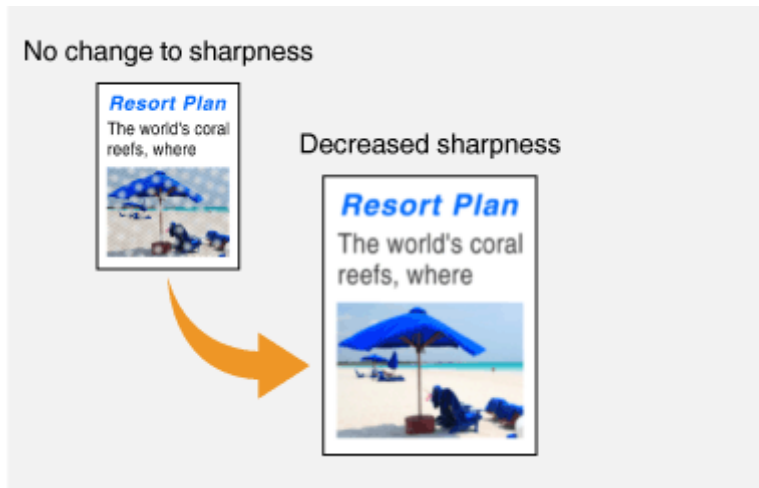

## LINKS

---

- ▶ **Basic Operations for Scanning Originals(P. 279)**
- ▶ **Sending I-Faxes(P. 244)**
- ▶ **Adjusting Density(P. 300)**

## Useful Scanning Functions

---

261J-05Y

The machine is equipped with useful functions such as those that can create secure PDF files to prevent them from being tampered with, and that can send data again to previously specified destinations.



▶ **Enhancing the Security of Electronic Files(P. 304)**



▶ **Adjusting Balance between File Size and Image Quality (Data Size) (P. 307)**



▶ **Recalling Previously Used Settings for Sending/Saving (Recall Settings)(P. 308)**



▶ **Specifying E-Mail Settings(P. 311)**

# Enhancing the Security of Electronic Files

261J-060



Digital files are vulnerable in terms of security because they can be easily viewed or tampered with leaving no trace. When scanning important documents, you can take appropriate measures such as encrypting data and adding a device signature to enhance security.

▶ **Encrypting a PDF File(P. 304)**

▶ **Adding a Device Signature(P. 305)**

## NOTE

- Encryption and device signature are only available for PDF files.
- Both the encryption and device signature can be used at the same time.

## Encrypting a PDF File

You can encrypt and send/save a PDF file by setting a password when scanning originals. The password setting helps reduce the risk of the PDF file being viewed or edited by others.

### 1 Select <Scan> in the Home screen. ▶ **Home Screen(P. 121)**

- If the login screen appears, specify the user name, the password, and the authentication server. ▶ **Logging in to Authorized Send(P. 132)**

### 2 Select <USB Memory>, <E-Mail>, or <File> in the Scan Basic Features screen. ▶ **Scan Basic Features Screen(P. 276)**

- If you select <USB Memory>, proceed to step 4.

### 3 Specify the destination, and specify the scanning settings as necessary. ▶ **Basic Operations for Scanning Originals(P. 279)**

### 4 Proceed to <Set PDF Details>.

#### ■ **Saving data to a USB memory device**

- Select <File Format> ▶ <Set PDF Details>.

#### ■ **Sending e-mail/saving data to a shared folder or FTP server**

- Select <File Format> in the <Send Settings> tab ▶ <Set PDF Details>.

### 5 Select the type of PDF format.

- You can specify whether to enable encryption for each PDF format.



## 6 Select <Encryption>.

## 7 Select the encryption level.



### <Acrobat 7.0 or Later/128-bit AES>

Encrypt the file in the 128-bit environment, which can be opened by Adobe Acrobat 7.0 or later.

### <Acrobat 10.0 or Equivalent/256-bit AES>

Encrypt the file in the 256-bit environment, which can be opened by Adobe Acrobat 10.0.

### NOTE:

- <Acrobat 10.0 or Equivalent/256-bit AES> can be changed to <Acrobat 9.0 or Equivalent/256-bit AES> with a different compatible version. ▶<256-bit AES Set. (Encrypt. PDF)>(P. 488)

## 8 Enter the encryption password, and select <Apply>.

- On how to enter text, see ▶<Entering Text(P. 130) .

## 9 Enter the same password, and select <Apply>.

## 10 Select <Apply>.

## Adding a Device Signature

Convert the scanned original into a PDF file with a device signature. The device signature serves the same purpose as sealing or signing a document; it can be used to check where the file was created and whether the document has been tampered with or falsified after the signature was appended. To assign the device signature to a PDF file, you need to generate the key and certificate for the device signature in advance. ▶<Generating a Device Signature Key(P. 413)

## 1 Select <Scan> in the Home screen. ▶<Home Screen(P. 121)

- If the login screen appears, specify the user name, the password, and the authentication server. ▶<Logging in to Authorized Send(P. 132)

## 2 Select <USB Memory>, <E-Mail>, or <File> in the Scan Basic Features screen. ▶<Scan Basic Features Screen(P. 276)

- If you select <USB Memory>, proceed to step 4.

**3 Specify the destination, and specify the scanning settings as necessary. ▶ Basic Operations for Scanning Originals(P. 279)**

**4 Proceed to <Set PDF Details>.**

**■ Saving data to a USB memory device**

- Select <File Format> ▶ <Set PDF Details>.

**■ Sending e-mail/saving data to a shared folder or FTP server**

- Select <File Format> in the <Send Settings> tab ▶ <Set PDF Details>.

**5 Select the type of PDF format.**

- You can specify whether to enable encryption for each PDF format.

**6 Select <Digital Signatures>.**

**7 Select <Top Left>.**

**8 Select <Apply>.**

# Adjusting Balance between File Size and Image Quality (Data Size)

261J-061



You can specify the file compression ratio when converting scanned originals into the JPEG format. <Small: Memory Priority> makes the compression ratio higher than normal to create smaller files with lower image quality. On the other hand, <Large: Image Quality Priority> makes the compression ratio lower than normal larger files with higher image quality.

## Saving Data to a USB Memory Device



<Scan> ▶ <USB Memory> ▶ <Data Size> ▶ Specify the setting

## Sending Data by E-Mail or Saving Data to the Server



<Scan> ▶ Specify destinations in <E-Mail>/<File> ▶ Select <Data Size> in the <Send Settings> tab ▶ Specify the setting

## LINKS

▶ **Basic Operations for Scanning Originals(P. 279)**

# Recalling Previously Used Settings for Sending/Saving (Recall Settings)

261J-062



You can select a destination from among the past destinations. When you specify a previously used destination, the machine also sets the same scan settings such as density you used the last time you sent documents to that destination.

## IMPORTANT

- When <Restrict Resending from Log> is set to <On>, you cannot use this feature. **▶Disabling Use of Previously Used Destinations(P. 403)**
- Turning OFF the machine or setting <Restrict New Destinations> to <On> deletes the past destinations, and disables this feature. **▶Restricting New Destinations that Can Be Specified(P. 403)**

## NOTE

- When you specify a destination using this feature, any destinations that you have already specified are deleted.

**1 Place the original(s).** **▶Placing Originals(P. 134)**

**2 Select <Scan> in the Home screen.** **▶Home Screen(P. 121)**

- If the login screen appears, specify the user name, the password, and the authentication server. **▶Logging in to Authorized Send(P. 132)**

**3 Select <E-Mail>, <I-Fax>, or <File> in the Scan Basic Features screen.** **▶Scan Basic Features Screen(P. 276)**

**4 Select <Recall Settings> in the <Specify Destination> tab.**

**5 Select the destination.**

- When you transmit to multiple destinations, only the address specified for the first transmission is displayed in the log, but all the destinations are specified.

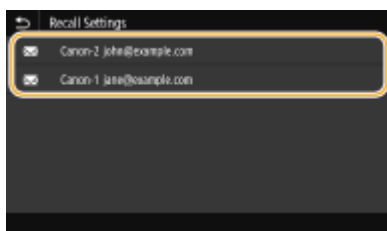

- ➡ The selected destination and its scan settings are specified. You can also change the settings before sending.

### ■ To delete destinations (e-mail/I-Fax)

If you specified multiple destinations, you can delete destinations as necessary.

- 1 Select <Confirm Destination>.
- 2 Select the check box for the destination to be deleted, and select <Remove from Dest.>.

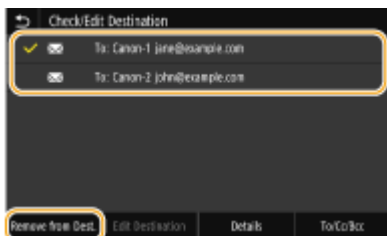

### NOTE:

- If you select the Group check box, you can view the destinations registered in the group by selecting <Details> ▶ <Destination>.

- 3 Select <Yes>.

## 6 Select <Start>.

- If the <Confirm Destination> screen is displayed, check whether the destination is correct, and then select <Start Scanning>.
- ➡ Scanning of the original starts.
  - If you want to cancel, select <Cancel> ▶ <Yes>. **▶ Canceling Sending Documents(P. 295)**

### ■ When placing originals in the feeder in step 1

When scanning is complete, the sending/saving process starts.

### ■ When placing originals on the platen glass in step 1

When scanning is complete, follow the procedure below (except if you selected JPEG as a file format).

- 1 If there are additional pages of originals to be scanned, place the next original on the platen glass, and select <Scan Next Original>.
  - Repeat this step until you finish scanning all of the pages.
  - When there is only one page to be scanned, proceed to the next step.

- 2 Select <Start Sending>.

➡ The sending/saving process starts.

### NOTE:

If the <File Authentication> or <SMTP Authentication> screen appears

- Enter the user name and password, and select <Apply>.

## LINKS

- ▶ **Basic Operations for Scanning Originals(P. 279)**

➤ **Sending I-Faxes(P. 244)**

# Specifying E-Mail Settings

261J-063



When attaching a scanned originals to an e-mail, you can specify the subject, message, reply-to address, and priority for the e-mail before sending it.

- 1** Place the original(s). ▶ **Placing Originals(P. 134)**
- 2** Select <Scan> in the Home screen. ▶ **Home Screen(P. 121)**
  - If the login screen appears, specify the user name, the password, and the authentication server. ▶ **Logging in to Authorized Send(P. 132)** .
- 3** Select <E-Mail> in the Scan Basic Features screen. ▶ **Scan Basic Features Screen(P. 276)**
- 4** Specify the destination, and configure the scan settings as necessary. ▶ **Basic Operations for Scanning Originals(P. 279)**
- 5** Specify the subject, message, reply-to address, and priority for the e-mail.

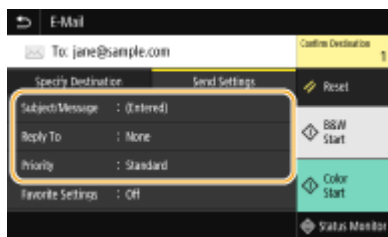

## ■ To specify subject/message

- 1** Select <Subject/Message> in the <Send Settings> tab.
- 2** Select <Subject>.
- 3** Enter the subject, and select <Apply>.
  - On how to enter text, see ▶ **Entering Text(P. 130)** .
- 4** Select <Message>.
- 5** Enter the message, and select <Apply>.
- 6** Select <Apply>.

## ■ To specify reply-to address

Specify the reply-to address when you want to notify the recipient of an e-mail address different from that of the machine as the reply-to address. Select the target reply-to address from the destinations registered in the

Address Book, and specify it. If the destination has not been registered in the Address Book, see [▶ Registering Destinations\(P. 176\)](#) .

- 1 Select <Reply To> in the <Send Settings> tab.
- 2 Select <Specify from Address Book>.
- 3 Select the check box for the desired reply-to address, and select <Apply>.

### ■ To specify priority

- 1 Select <Priority> in the <Send Settings> tab.
- 2 Select a priority level.

## 6 Select <Start>.

- If the <Confirm Destination> screen is displayed, check whether the destination is correct, and then select <Start Scanning>.
  - ▣ Scanning of the original starts.
    - If you want to cancel, select <Cancel> ▶ <Yes>. [▶ Canceling Sending Documents\(P. 295\)](#)

### ■ When placing originals in the feeder in step 1

When scanning is complete, the e-mails are sent.

### ■ When placing originals on the platen glass in step 1

When scanning is complete, follow the procedure below (except if you selected JPEG as a file format).

- 1 If there are additional pages of originals to be scanned, place the next original on the platen glass, and select <Scan Next Original>.
  - Repeat this step until you finish scanning all of the pages.
  - When there is only one page to be scanned, proceed to the next step.
- 2 Select <Start Sending>.
  - ▣ The e-mails are sent.

### NOTE:

If the <SMTP Authentication> screen appears

- Enter the user name and password, and select <Apply>.

## TIPS

- If you always want to scan with the same settings: [▶ Changing the Default Settings for Functions\(P. 170\)](#)
- If you want to register a combination of settings to use when needed: [▶ Registering Frequently Used Settings\(P. 168\)](#)
- If you want to specify the e-mail sender name: [▶ <Register Unit Name>\(P. 518\)](#)



LINKS

---

▶ **Checking Status and Log for Scanned Originals(P. 296)**

## Using Your Computer to Scan (Remote Scan)

261J-064

To scan from a computer, you can use MF Scan Utility or an application such as an image processing or word processing application. If you use ScanGear MF supplied with the machine, you can configure advanced scan settings ( [Using ScanGear MF\(P. 317\)](#) ).

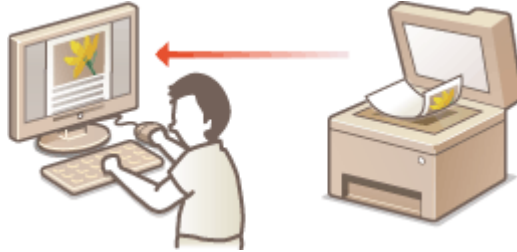

### IMPORTANT

- When using the machine with a USB connection, exit sleep mode before scanning. [Entering Sleep Mode\(P. 174\)](#)

### Scanning Using MF Scan Utility



MF Scan Utility is an application included with the machine that enables you to scan documents or images to a computer. You can forward the scanned data to a specified application, or attach it to an e-mail message. For more information, click [Instructions] on MF Scan Utility.

### NOTE

- If you are a macOS user, see the manuals for the relevant drivers or software on the online manual website.

### Scanning Using an Application



You can scan images by using an application such as a word-processing or image-processing application, and load the images directly into the application. You do not need to start another application to scan. [Scanning Documents from an Application\(P. 315\)](#)

# Scanning Documents from an Application

261J-065



You can scan originals from applications such as image-processing or word-processing software. The scanned image is directly loaded in the application, allowing you to edit or process the image immediately. The following procedure varies depending on the application.

## IMPORTANT

- The application must be compatible with TWAIN or WIA\*. For more information, see the instruction manual for your application.

\*TWAIN is a standard for connecting image input devices, such as scanners, with computers. WIA is a function that is an integrated standard in Windows.

### 1 Place the original(s). ▶ **Placing Originals(P. 134)**

#### IMPORTANT:

- The second or subsequent originals may not be scanned, or an error message may be displayed depending on the application. In such a case, place and scan one original at a time.
- When <Auto Online> is set to <Off>, you must select <Scan> ▶ <Remote Scanner> in the Home screen to bring the machine online. ▶ **<Auto Online>(P. 487)**

### 2 From the application, select the start scan command.

- The procedure for selecting the start scan command varies depending on the application. For more information, see the instruction manual for your application.

### 3 Select the scanner driver for this machine.

- Select ScanGear MF or WIA. If you select ScanGear MF, you can configure advanced scan settings.

### 4 Specify the scanning settings as necessary.

### 5 Click [Scan].

⇒ Scanning of the original starts.

- When scanning is complete, the scanned image is forwarded to an application.

#### How to use ScanGear MF

- Click  on the ScanGear MF screen, and see the Help.

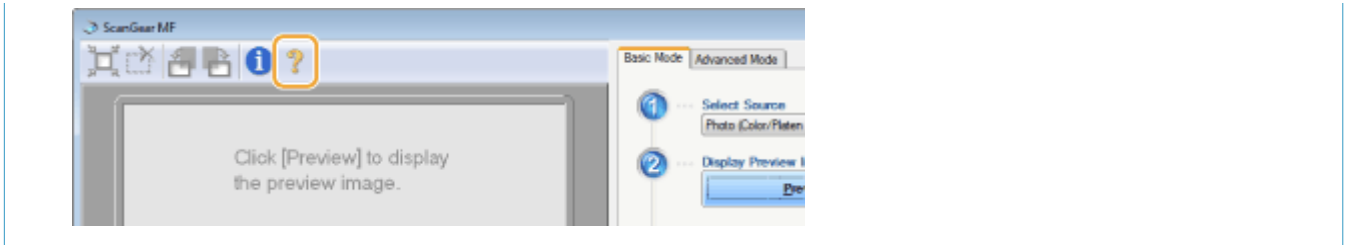

## LINKS

---

▶ **Using ScanGear MF(P. 317)**

## Using ScanGear MF

261J-066



ScanGear MF is a scanner driver included with the machine. You can use ScanGear MF to configure advanced scan settings when you scan. The way of starting ScanGear MF differs depending of the way of scanning from the computer.

### Starting from MF Scan Utility

When scanning from MF Scan Utility, click [ScanGear] to start ScanGear MF. For more information, click [Instructions] on MF Scan Utility.

### NOTE

- If you are a macOS user, see the manuals for the relevant drivers or software on the online manual website.

### Starting from an application

To scan from applications such as image-processing or word-processing software, select ScanGear MF as scanner driver. **☞ Scanning Documents from an Application(P. 315)**

## TIPS

### Functions of ScanGear MF

- Previewing the image before scanning
- Specifying the scanning area
- Adjusting the detailed image quality

### How to use ScanGear MF

- Click  on the ScanGear MF screen, and see the Help.

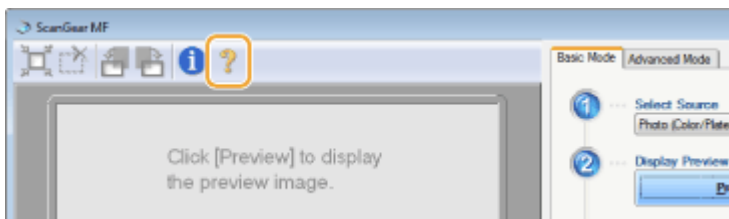

# Linking with Mobile Devices

<b>Linking with Mobile Devices</b> .....	319
<b>Connecting with Mobile Devices</b> .....	320
Connecting via a Wireless LAN Router (LAN Connection) .....	321
Connecting Directly (Access Point Mode) .....	323
<b>Utilizing the Machine through Applications</b> .....	327
<b>Using AirPrint</b> .....	328
Printing with AirPrint .....	333
Scanning with AirPrint .....	336
Faxing with AirPrint .....	338
If AirPrint Cannot Be Used .....	340
<b>Using Google Cloud Print</b> .....	341
<b>Managing the Machine by the Remote Control</b> .....	343

# Linking with Mobile Devices

261J-067

Linking the machine with mobile devices such as smart phones and tablets enables you to use an appropriate application to perform printing, or other operation with ease. In addition, you can operate the machine from mobile devices via remote control to confirm printing status and change the settings of the machine.



- ▶ **Connecting with Mobile Devices(P. 320)**
- ▶ **Connecting Directly (Access Point Mode)(P. 323)**
- ▶ **Utilizing the Machine through Applications(P. 327)**
- ▶ **Using AirPrint(P. 328)**
- ▶ **Using Google Cloud Print(P. 341)**
- ▶ **Managing the Machine by the Remote Control(P. 343)**

## IMPORTANT

- Depending on your mobile device, the machine may not operate correctly.

## NOTE

- When [Restrict IPP Port (Port Number: 631)] or [Restrict mDNS Port (Port Number: 5353)] is enabled in Security Policy ( ▶ **Security Policy(P. 431)** ), you can use neither Mopria® or AirPrint.

## Connecting with Mobile Devices

---

261J-068

There are two methods used to connect a mobile device with the machine: connecting via a wireless LAN router, and communicating wirelessly and directly with the machine. Select a connection method in accordance with the communication environment and the device you are using. Perform communication with mobile devices from <Mobile Portal> ( ▶ **Home Screen(P. 121)** ).

### ■ Connecting via a Wireless LAN Router

Just as connecting a computer to the machine, connect a mobile device to the machine via a wireless LAN router. ▶ **Connecting via a Wireless LAN Router (LAN Connection)(P. 321)**



### ■ Connecting Directly

Directly connect a mobile device to the machine wirelessly without using wireless LAN. It is possible to immediately connect to the machine wirelessly even outside of a wireless LAN environment. ▶ **Connecting Directly (Access Point Mode)(P. 323)**





## Connecting via a Wireless LAN Router (LAN Connection)

261J-069

If a wireless LAN router is connected to the network connected to the machine, you can establish a communication with a mobile device via the wireless LAN router in the same way for a computer. For information about how to connect a mobile device to your wireless LAN router, see the instruction manuals for your networking devices or contact your manufacturer. Connect the machine to a router via the wired or wireless LAN. **▶Setting Up the Network Environment(P. 14)**



### NOTE

- To perform the procedures below, use the IPv4 address. **▶Setting IPv4 Address(P. 32)**
- Select <LAN Connection> and proceed with the procedure, if the <Direct Connection> screen is displayed after <Mobile Portal> is selected in the procedure below.
- For information about the operating systems compatible with Canon PRINT Business, the detailed setting procedure, and the operating procedure, please see the application's Help or the Canon website (<http://www.canon.com/gomp/>).

#### ■ Connecting Manually

- 1 Select <Mobile Portal> in the Home screen. ▶Home Screen(P. 121)**
- 2 Connect from the mobile device to the IP address that appears on the screen.**

#### ■ Connecting Using a QR Code

- 1 Select <Mobile Portal> in the Home screen. ▶Home Screen(P. 121)**
- 2 Select <QR Code>.**
- 3 Launch Canon PRINT Business on the mobile device. ▶Utilizing the Machine through Applications(P. 327)**
- 4 Read the QR code displayed on the screen using the mobile device.**



### ■ Connecting Using the NFC (Android)

Before using the NFC, check whether <Use NFC> is set to <On>. ▶<Use NFC>(P. 547)

- 1 Launch Canon PRINT Business on the mobile device. ▶Utilizing the Machine through Applications(P. 327)**
- 2 Enable the NFC settings of the mobile device.**
- 3 Move the mobile device closer to the NFC mark of the machine. ▶Operation Panel(P. 113)**



## Connecting Directly (Access Point Mode)

261J-06A

Even in an environment without a wireless LAN router, using "Access Point Mode," which can directly connect a mobile device to the machine wirelessly, enables you to connect the mobile device on hand to the machine without difficult settings.





▶ **Preparing for Direct Connection (Access Point Mode)(P. 323)**

▶ **Connecting Directly(P. 324)**

### Preparing for Direct Connection (Access Point Mode)

Establish a connection by using Access Point Mode in the following order.

- 1  **Check the network settings of the machine.**
  - Set the IPv4 address. ▶ **Setting IPv4 Address(P. 32)**
- 2  **Preparing the mobile device**
  - Configure settings to connect the mobile device to Wi-Fi.
- 3  **Put the machine into the connection standby status.**
  - <Menu> ▶ <Preferences> ▶ <Network> ▶ <Direct Connection Settings> ▶ set <Use Direct Connection> to <On>.

## NOTE

### Specifying the value for time until auto termination

- You can specify the time to automatically establish a disconnection when the direct connection is enabled. ▶ **<Direct Connection Termination>(P. 459)**

### Connecting multiple mobile devices at the same time

- Configure the machine's SSID and network key arbitrarily. ▶ **<Access Point Mode Settings>(P. 459)**

### Canon PRINT Business

- For information about the operating systems compatible with Canon PRINT Business, the detailed setting procedure, and the operating procedure, please see the application's Help or the Canon website (<http://www.canon.com/gomp/>).

## Connecting Directly

### IMPORTANT

- It may take time until a connection of the machine and the mobile device is established.

#### ■ Connecting Manually

**1** Select <Mobile Portal> in the Home screen. ▶ Home Screen(P. 121)

- When any mobile device is already connected, proceed to step 3.

**2** Select <Connect>.

**3** Configure the Wi-Fi settings from the mobile device using the SSID and network key information that appear on the screen.

**4** When the target operation is completed, select <Disconnect>.

#### ■ Connecting Using a QR Code

**1** Select <Mobile Portal> in the Home screen. ▶ Home Screen(P. 121)

- When any mobile device is already connected, proceed to step 3.

**2** Select <Connect>.

**3** Select <QR Code>.

**4** Launch Canon PRINT Business on the mobile device. ▶ Utilizing the Machine through Applications(P. 327)

**5** Read the QR code displayed on the screen using the mobile device.



**6** When the target operation is completed, then select <Disconnect>.

### ■ Connecting Using the NFC (Android)

Before using the NFC, check whether <Use NFC> is set to <On>. ▶<Use NFC>(P. 547)

**1** Select <Mobile Portal> in the Home screen. ▶Home Screen(P. 121)

- When any mobile device is already connected, proceed to step 3.

**2** Select <Connect>.

**3** Launch Canon PRINT Business on the mobile device. ▶Utilizing the Machine through Applications(P. 327)

**4** Enable the NFC settings of the mobile device.

**5** Move the mobile device closer to the NFC mark of the machine. ▶Operation Panel(P. 113)



**6** When the target operation is completed, then select <Disconnect>.

## TIPS

- Select <Connection Information> on the <Direct Connection> screen to check the connected mobile device.

## IMPORTANT

- While connecting via direct connection, you may not be able to connect to the Internet depending on the mobile device you are using.
- If a wireless connection from the mobile device is not performed within 5 minutes while the SSID and network key are displayed, the connection waiting state terminates.

- If the status without data transmission between the mobile device and the machine continues during communication by direct connection, the communication may end.
- Power saving performance of sleep mode degrades while connecting via direct connection.
- If the machine is used with a wireless LAN, you need to keep the machine connected to the wireless LAN when using direct connection. When the machine is not connected to a wireless LAN or the connection process is not complete yet, the direct connection process cannot begin. If the connection between the machine and the wireless LAN is lost during communication through direct connection, the communication may end.
- When you finish the desired operation, be sure to terminate the connection between the machine and the mobile device. If they remain connected, power saving performance of sleep mode degrades.
- If you use the direct connection, do not set the IP address manually on the mobile device. Doing so may prevent proper communication after using the direct connection.

## Utilizing the Machine through Applications

261J-06C

Perform printing and other operations from the mobile device connected to the machine using applications. Various applications including those exclusive to Canon are supported. Use properly in accordance with your device, the application, and the situation.

### ■ Using Canon PRINT Business

This application is used to perform printing and other operations from mobile devices that support iOS/Android. When printing, it is not necessary to perform operations on the machine. For more information on supported operating systems, detailed setting methods, and operations, see the application's Help or the Canon website (<http://www.canon.com/gomp/>).

## IMPORTANT

- You can download Canon PRINT Business for free, but you will be charged the Internet connection fee.

### ■ Printing with Canon Print Service

You can easily print from the menu of applications that support the Android print subsystem. For more information on supported operating systems and detailed settings and procedures, see the Canon website (<http://www.canon.com/>).

### ■ Printing by Mopria®

The machine also supports Mopria®. Using Mopria® enables you to print from mobile devices that support Android using common operations and settings, even if manufacturers and models differ. For example, if you are using printers supporting Mopria® made by multiple manufacturers or a printer supporting Mopria® that is located in a place you are visiting, you can print without installing an application exclusive for each manufacturer or model. For more information on supporting models or operation environments, see <http://www.mopria.org>.



### Confirming Mopria® Settings



Log in to the Remote UI with Administrator privileges ( ▶ **Starting Remote UI(P. 415)** ) ▶ [Settings/Registration] ▶ [Network Settings] ▶ [Mopria Settings] ▶ [Edit] ▶ Check that the [Use Mopria] check box is selected ▶ [OK]

### ■ Printing with Google Cloud Print

You can use applications and services which support Google Cloud Print to print from a computer or mobile device without using a printer driver. ▶ **Using Google Cloud Print(P. 341)**

# Using AirPrint

261J-06E

This section describes the settings required to use AirPrint and the procedures to be performed using Apple devices.



## AirPrint Settings

- ▶ [Configuring AirPrint Settings\(P. 328\)](#)
- ▶ [Displaying the Screen for AirPrint\(P. 331\)](#)

## Functions of the AirPrint

- ▶ [Printing with AirPrint\(P. 333\)](#)
- ▶ [Scanning with AirPrint\(P. 336\)](#)
- ▶ [Faxing with AirPrint\(P. 338\)](#)

## Troubleshooting

- ▶ [If AirPrint Cannot Be Used\(P. 340\)](#)

## Configuring AirPrint Settings

You can register information, including the name of the machine and installation location, that is used for identifying the machine. You can also disable the AirPrint function of the machine. Use the Remote UI to change these settings.

### NOTE

- For more information about the basic operations to be performed when setting the machine from the Remote UI, see [▶Setting Up Menu Options from Remote UI\(P. 424\)](#) .

- 1** Start the Remote UI and log in to System Manager Mode. [▶Starting Remote UI\(P. 415\)](#)
- 2** Click [Settings/Registration] on the Portal page. [▶Remote UI Screen\(P. 416\)](#)
  - If you are using a mobile device, such as an iPad, iPhone, or iPod touch, read "click" as "tap" in this section.
- 3** Select [Network Settings] ▶ [AirPrint Settings].
- 4** Click [Edit].



## 5 Specify the required settings.

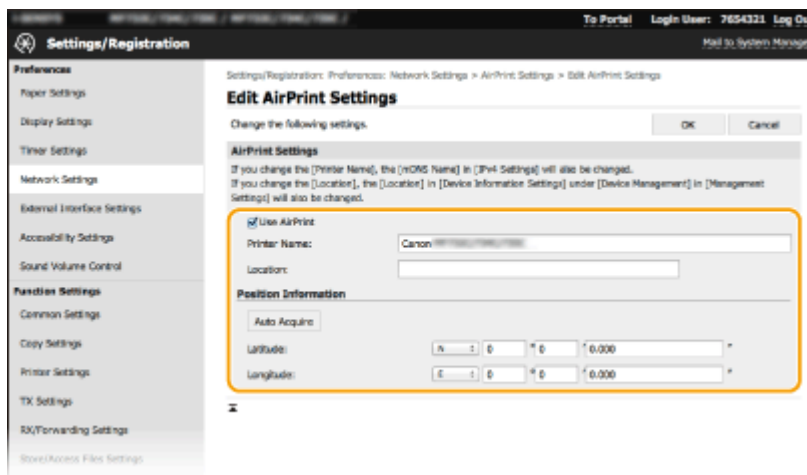

### [Use AirPrint]

Select the check box to enable AirPrint. To disable AirPrint, clear the check box.

### [Printer Name]

Enter the name of the machine. If an mDNS name has already been registered in [mDNS Settings] ( [▶ Configuring DNS\(P. 56\)](#) ), the registered name is displayed.

### [Location]

Enter the location of the machine. If a location has already been registered in [Device Information Settings] ([Device Management] in [Management Settings] (Settings/Registration)), the registered name is displayed.

### [Latitude]

Enter the latitude of the location where the machine is installed.

### [Longitude]

Enter the longitude of the location where the machine is installed.

## 6 Click [OK].

## IMPORTANT

If you select [Use AirPrint], the following settings in <Network> are set to <On>.

- Use HTTP
- IPP Print Settings
- IPv4 Use mDNS
- IPv6 Use mDNS
- Use Network Link Scan

## NOTE

- If you change [Printer Name] that you have once specified, you may be unable to print any more from the Mac that has been able to be used for printing so far. This phenomenon occurs because <mDNS Name> ( [▶ Configuring DNS\(P. 56\)](#) ) of IPv4 is also changed automatically. In this case, add the machine to the Mac again.
- Entering the printer name makes it easier to identify multiple printers that support AirPrint.

## ■ Changing the Setting of Functions Available with AirPrint

If you want to disable functions that you are not going to use with AirPrint or encrypt communications, configure the necessary setting using the operation panel.

### Changing Print and Fax Settings

To perform printing or fax sending with AirPrint, IPP protocol is used.

#### Turning the Function On/Off

You can specify whether to perform printing and fax sending with AirPrint. The factory default setting is <On>.



<Menu> ▶ <Preferences> ▶ <Network> ▶ <TCP/IP Settings> ▶ <IPP Print Settings> ▶ Set <Use IPP Printing> to <Off> or <On> ▶ <Apply> ▶ 

#### Changing the TLS Setting

You can specify whether to encrypt communications using TLS when performing printing or sending faxes with AirPrint. The factory default setting is <Off>.



<Menu> ▶ <Preferences> ▶ <Network> ▶ <TCP/IP Settings> ▶ <IPP Print Settings> ▶ Set <Use TLS> to <Off> or <On> ▶ <Apply> ▶ 

### Changing the Scan Setting

Configure the scan setting using AirPrint.

#### Set the Function to Enable or Disable

You can turn on/off the scan function available with AirPrint. The factory default setting is <On>.



<Menu> ▶ <Preferences> ▶ <Network> ▶ <TCP/IP Settings> ▶ <Network Link Scan Settings> ▶ Set <Use Network Link Scan> to <Off> or <On> ▶ <Apply> ▶ 

#### Change TLS Settings

You can specify whether or not to encrypt TLS communications when scanning data using AirPrint. The factory default setting is <Off>.



<Menu> ▶ <Preferences> ▶ <Network> ▶ <TCP/IP Settings> ▶ <Network Link Scan Settings> ▶ Set <Use TLS> to <Off> or <On> ▶ <Apply> ▶ 

## Displaying the Screen for AirPrint

You can display the screen for AirPrint, on which you can not only access the AirPrint Settings but also view information about consumables, such as paper and toner cartridge. Further, you can configure security function settings.

- 1 Select [System Preferences] ▶ [Printers & Scanners], then add the machine to the Mac you are using.**
  - If the machine has already been added, this operation is not required.
- 2 Select this machine from the list of printers in [Printers & Scanners].**
- 3 Click [Options & Supplies].**
- 4 Click [Show Printer Webpage].**
- 5 Log in to the Remote UI.**
  - To change the AirPrint settings, it is necessary to log in as an administrator.

### ■ AirPrint-Dedicated Page

When you log in with administrator privileges, the AirPrint-dedicated page is displayed as shown below.

The screenshot displays the AirPrint Remote UI interface. It is divided into several sections, each highlighted with a yellow border and a numbered callout (1, 2, or 3) on the right side:

- 1 AirPrint Settings:** This section includes fields for 'Use AirPrint' (set to 'On'), 'Printer Name' (Canon iPPAF0000), 'Location', 'Latitude' (N24°03.000'), and 'Longitude' (E139°03.000'). An 'Edit...' button is located in the top right corner.
- 2 Other Settings:** This section contains links for 'Print Security Settings', 'Scan Security Settings', 'TLS Settings', and 'Key and Certificate Settings'.
- 3 Consumables Information:** This section is divided into two sub-sections:
  - Paper Information:** A table showing 'Paper Source' (Multi-Purpose Tray), 'Paper Level' (None), 'Paper Size' (A4), and 'Paper Type' (Plain 2 (75-85 g/m<sup>2</sup>)).
  - Cartridge Information:** Shows 'Color' (Black) and 'Toner Level' (100%), with a corresponding progress bar.

At the bottom of the page, there is a 'Device Version Information' section showing 'Main Controller' as '00.00'. The footer includes 'Copyright CANON INC. 2017'.

#### 1 [AirPrint Settings]

Enables you to check the values entered in the AirPrint settings, such as the name and location of the machine. You can click [Edit] to change the settings.

## 2 [Other Settings]

### [Print Security Settings]

Configure the print security settings using TLS or authentication.

### [Scan Security Settings]

Configure the scan security settings using TLS.

### [TLS Settings]

Enables you to change the key and certificate used for TLS. ▶ **Configuring the Key and Certificate for TLS(P. 376)**

### [Key and Certificate Settings]

Enables you to generate and install a key and certificate, or request a certificate to be issued. ▶ **Configuring the Key and Certificate for TLS(P. 376)**

## 3 [Consumables Information]

Enables you to check the information of each paper source and consumables of the machine and the device version.

## Trademarks

Apple, Bonjour, iPad, iPhone, iPod touch, Mac, macOS, OS X and Safari are trademarks of Apple Inc., registered in the U.S. and other countries. AirPrint and the AirPrint logo are trademarks of Apple Inc.

# Printing with AirPrint

You can print from an iPad, iPhone, iPod touch, or Mac without using a printer driver.

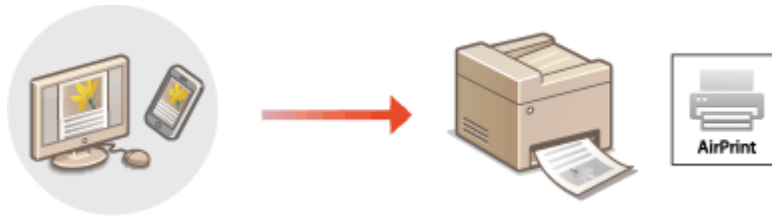

▶ **Printing from an iPad, iPhone, or iPod touch(P. 333)**

▶ **Printing from a Mac(P. 334)**

## System Requirements

One of the following Apple devices is required to print with AirPrint.

- iPad (all models)
- iPhone (3GS or later)
- iPod touch (3rd generation or later)
- Mac (Mac OS X 10.7 or later)\*

\*OS X v10.9 or later when using a USB connection

## Network Environment

One of the following environments is required.

- An environment where an Apple device and the machine are connected to the same LAN
- An environment where an Apple device and the machine are connected directly
- An environment where a Mac is connected to the machine via USB

## IMPORTANT

- For printing, it is required to set <Use IPP Printing> to <On>. ▶ **Changing the Setting of Functions Available with AirPrint(P. 330)**

## Printing from an iPad, iPhone, or iPod touch

**1 Make sure that the machine is turned ON and connected to the Apple device.**

- For how to make sure of this, see ▶ **Setting Up the Network Environment(P. 14)** .
- For information on the Direct Connection, see ▶ **Connecting Directly (Access Point Mode)(P. 323)** .

**2 From the application on your Apple device, tap  to display the menu options.**

**3 Tap [Print].****4 Select this machine from [Printer].**

- The printers connected to the network are displayed here. Select this machine in this step.

**IMPORTANT:**

- The screen for selecting this machine in [Printer] is not displayed on applications that do not support AirPrint. You cannot print by using those applications.

**5 Specify the print settings as necessary.****NOTE:**

- The available settings and paper sizes differ depending on the application you are using.

**6 Tap [Print].**

▢▢▢ Printing starts.

**NOTE:****Checking the print status**

- During printing, press the Home button of the Apple device twice ► tap [Print].

## Printing from a Mac

**1 Make sure that the machine is turned ON and connected to the Mac.**

- For how to make sure of this, see [▶Setting Up the Network Environment\(P. 14\)](#) .

**2 Add the machine to the Mac from [System Preferences] ► [Printers & Scanners].**

- If the machine has already been added, this operation is not required.

**3 Open a document in an application and display the print dialog box.**

- How to display the print dialog box differs for each application. For more information, see the instruction manual or Help for the application you are using.

**4 Select the machine in the print dialog box.**

- The printers connected to the Mac are displayed. Select this machine in this step.

**5 Specify the print settings as necessary.**

**NOTE:**

- The available settings and paper sizes differ depending on the application you are using.

**6 Click [Print].**

⇒ Printing starts.

## Scanning with AirPrint

261J-06H

You can use AirPrint to transfer the data scanned by the machine directly to a Mac.

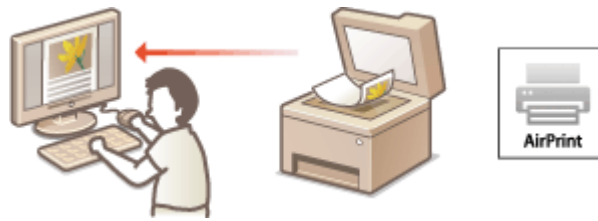

### System Requirements

To scan with AirPrint, you need a Mac with OS X 10.9 or later installed. To scan using TLS, you need a Mac with OS X 10.11 or later installed.

### Network Environment

One of the following environments is required.

- An environment where an Apple device and the machine are connected to the same LAN
- An environment where a Mac is connected to the machine via USB

## IMPORTANT

- For scanning, it is required to set <Use Network Link Scan> to <On>. **▶ Changing the Setting of Functions Available with AirPrint(P. 330)**
- Before scanning, it is required to put the machine into online state. When the auto online function ( **▶ <Auto Online>(P. 487)** ) is set to <Off>, first put the machine into online state by selecting <Scan> ▶ <Remote Scanner>, then start the procedure for scanning.
- You cannot scan while settings for operations are being made, or while the machine is performing any operation whatsoever.

## Scanning from a Mac

### 1 Make sure that the machine is turned ON and connected to the Mac.

- For how to make sure of this, see **▶ Setting Up the Network Environment(P. 14)** .

### 2 Add the machine to the Mac from [System Preferences] ▶ [Printers & Scanners].

- If the machine has already been added, this operation is not required.

### 3 Select this machine from the list of printers in [Printers & Scanners].

### 4 Click [Scan].



**5 Click [Open Scanner].**

⇒ The [Scanner] screen is displayed.

**6 Configure the scan settings as necessary.**

**7 Click [Scan].**

⇒ The original is scanned, and the image is displayed.

## Faxing with AirPrint

261J-06J

You can send faxes from a Mac in almost the same way as when you print from a Mac.



### System Requirements

To send faxes with AirPrint, you need a Mac with OS X 10.9 or later installed.

### Network Environment

One of the following environments is required.

- An environment where an Apple device and the machine are connected to the same LAN
- An environment where a Mac is connected to the machine via USB

## IMPORTANT

- For faxing, it is required to set <Use IPP Printing> to <On>. [▶ Changing the Setting of Functions Available with AirPrint\(P. 330\)](#)

## Faxing from a Mac

### 1 Make sure that the machine is turned ON and connected to the Mac.

- For how to make sure of this, see [▶ Setting Up the Network Environment\(P. 14\)](#) .

### 2 Add the machine to the Mac from [System Preferences] ▶ [Printers & Scanners].

- If the machine has already been added, this operation is not required.

### 3 Open a document in an application and display the print dialog box.

- How to display the print dialog box differs for each application. For more information, see the instruction manual for the application you are using.

### 4 Select this machine in the print dialog box.

- ▢ The printers connected to the Mac are displayed. Select the fax driver of this machine in this step.

### 5 Specify the destination.

## 6 Click [Fax].

⇒ Fax sending starts.

## If AirPrint Cannot Be Used

---

261J-06K

If AirPrint cannot be used, try taking the following solutions.

- Make sure that the machine is turned ON. If the machine is turned ON, first turn it OFF, then wait for at least 10 seconds and then turn it back ON to check if the problem is solved.
- Make sure that no error messages are displayed on the machine.
- Make sure that Apple devices and the machine are connected to the same LAN. If the machine is turned ON, it may take several minutes before the machine is ready for communication.
- Make sure that Bonjour on your Apple device is enabled.
- Make sure that the machine is configured to enable execution of jobs from a computer even when no department ID and password are entered. **▶Blocking Jobs When Department ID Is Unknown(P. 355)**
- For printing, make sure that the paper is loaded in the machine and that the machine contains a sufficient amount remaining in the toner cartridges. **▶Displaying the Screen for AirPrint(P. 331)**
- For scanning, make sure that the machine's setting for Network Link Scan is <On>. **▶Changing the Setting of Functions Available with AirPrint(P. 330)**

## Using Google Cloud Print

261J-06L

Google Cloud Print is a service that enables a user with a Google account to print from a smartphone, tablet, or computer connected to the Internet using applications compatible with Google Cloud Print. Unlike conventional printing from a computer, it does not require a printer driver.



- ▶ **Checking the Settings of the Machine(P. 341)**
- ▶ **Registering the Machine with Google Cloud Print(P. 341)**

### IMPORTANT

- An environment in which you can connect to the internet is required when registering the machine and when printing using Google Cloud Print. In addition, the customer is responsible for any fees regarding internet connection.
- Google Cloud Print may not be available, depending on your country or region.
- Google Cloud Print does not support printing from an IPv6 address.

### NOTE

- A Google account is required to use Google Cloud Print. If you do not have a Google account, create one on the Google website.

### Checking the Settings of the Machine

Check the following before configuring cloud printing.

- Make sure that the IPv4 address is specified for the machine, and that the machine is able to communicate with computers on a network.
  - ▶ **Connecting to a Wired LAN(P. 17)**
  - ▶ **Connecting to a Wireless LAN(P. 18)**
- Check whether the date and time of the machine are specified correctly. ▶ **Setting the Date/Time(P. 12)**
- If Department ID Management is set, make sure that you can print from a computer without entering a Department ID or PIN. ▶ **Blocking Jobs When Department ID Is Unknown(P. 355)**

### Registering the Machine with Google Cloud Print

Registering the machine with Google Cloud Print enables you to print from anywhere using the service.

### NOTE

- For more information about the basic operations to be performed when setting the machine from the Remote UI, see [▶Setting Up Menu Options from Remote UI\(P. 424\)](#) .

- 1 Start the Remote UI and log in as an administrator.** [▶Starting Remote UI\(P. 415\)](#)
- 2 Click [Settings/Registration] on the Portal page.** [▶Remote UI Screen\(P. 416\)](#)
- 3 Select [Network Settings] ▶ [Google Cloud Print Settings].**
- 4 Click [Edit] for [Basic Settings].**
- 5 Select the [Use Google Cloud Print] check box ▶ [OK].**
- 6 Click [Register] in [Registration Status].**

### NOTE:

#### Re-Registering the Machine

- To re-register the machine, delete its registration before registering it again.

- 7 Click the URL link displayed for [URL for Registration].**
- 8 Follow the instructions on the screen to register the machine.**

⇒ Printing can now be performed from applications that support Google Cloud Print, such as Google Chrome™.

### NOTE:

- For information on the latest applications that support Google Cloud Print, check the Google Cloud Print home page.

## NOTE

### Configuring Settings on the Operation Panel

- You can also enable or disable the Cloud Print function from <Menu> in the Home screen. [▶<Google Cloud Print Settings>\(P. 470\)](#)

### Registering from a Mobile Device or Google Chrome

- You can register the machine from a mobile device or Google Chrome. The machine's display shows the confirmation screen before completion of the registration. Press <Yes> to complete the registration.
- For information on registration methods, see the manual of your device or the Google Cloud Print website.

# Managing the Machine by the Remote Control

261J-06R

You can use the Remote UI from a smart phone or tablet Web browser. You can confirm the machine status or perform various settings from a mobile device. Note that the Remote UI screen may not be displayed properly for some devices and environments.



## Starting the Remote UI from Mobile Devices

Enter the IP address of the machine on the Web browser to start the Remote UI. Prior to operation, confirm the IP address set for the machine ( [Viewing Network Settings\(P. 38\)](#) ). If it is unknown, ask your network administrator.

### 1 Start the Web browser of the mobile device.

### 2 Enter "http://<the IP address of the machine>/" in the address entry column.

- If you want to use an IPv6 address, enclose the IPv6 address with brackets.  
**Example:** http://[fe80:2e9e:fcff:fe4e:dbce]/

#### NOTE:

- For a "Smartphone Version" of the Remote UI, a portion of items displayed are omitted. If you want to confirm all of the items, see the "PC Version."

## LINKS

- [Managing the Machine from a Computer \(Remote UI\)\(P. 414\)](#)

# Managing the Machine

<b>Managing the Machine</b> .....	346
<b>Setting Access Privileges</b> .....	348
Setting the System Manager ID and PIN .....	349
Setting the Department ID Management .....	351
Setting a Remote UI PIN .....	357
LDAP Server Authentication .....	359
<b>Configuring the Network Security Settings</b> .....	363
Restricting Communication by Using Firewalls .....	365
Specifying IP Addresses for Firewall Settings .....	366
Specifying MAC Addresses for Firewall Settings .....	369
Changing Port Numbers .....	372
Setting a Proxy .....	374
Configuring the Key and Certificate for TLS .....	376
Generating the Key and Certificate for Network Communication .....	379
Generating a Key and Certificate Signing Request (CSR) .....	382
Registering the Key and Certificate for Network Communication .....	385
Configuring IPSec Settings .....	387
Configuring IEEE 802.1X Authentication Settings .....	394
<b>Restricting the Machine's Functions</b> .....	398
Restricting Access to Address Book and Sending Functions .....	400
Restricting Use of the Address Book .....	401
Limiting Available Destinations .....	403
Restricting the Fax Sending Functions .....	405
Restricting Printing from a Computer .....	407
Restricting USB Functions .....	408
Disabling HTTP Communication .....	410
Disabling Remote UI .....	411
<b>Increasing the Security of Documents</b> .....	412
Generating a Device Signature Key .....	413
<b>Managing the Machine from a Computer (Remote UI)</b> .....	414
Starting Remote UI .....	415
Checking the Status and Logs .....	418
Setting Up Menu Options from Remote UI .....	424
Registering Destinations from Remote UI .....	427
Security Policy .....	431



Importing/Exporting the Setting Data .....	437
<b>Updating the Firmware</b> .....	440
<b>Initializing Settings</b> .....	442

# Managing the Machine

261J-06S

To reduce the various risks associated with the use of this machine, such as leaks of personal information or unauthorized use by third parties, constant and effective security measures are required. An administrator should manage important settings, such as access privileges and security settings, to ensure that the machine is used safely.

## ■ Configuring the Basic Management System

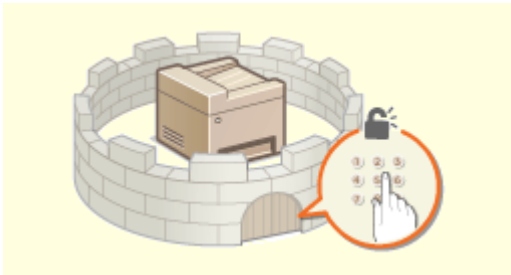

▶ **Setting Access Privileges(P. 348)**

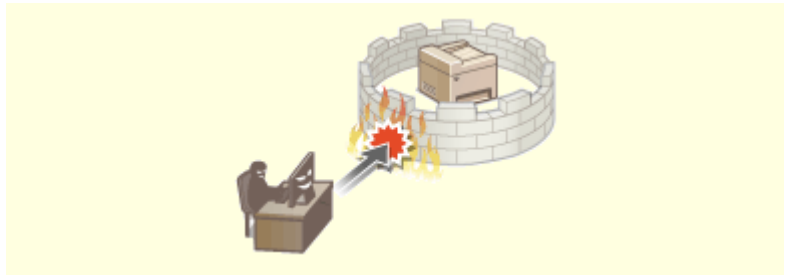

▶ **Configuring the Network Security Settings(P. 363)**

## ■ Preparing for Risks from Negligence or Misuse



▶ **Restricting the Machine's Functions(P. 398)**



▶ **Increasing the Security of Documents(P. 412)**

## ■ Ensuring Effective Management



▶ **Managing the Machine from a Computer (Remote UI)(P. 414)**

■ Managing the System Configuration and Settings



▶ **Updating the Firmware(P. 440)**



▶ **Initializing Settings(P. 442)**

## Setting Access Privileges

---

261J-06U

Protect the machine from unauthorized access by only allowing users with access privileges to use the machine. Access privileges are set separately for system administrators, general users, and the Remote UI. When privileges are set, the user must enter an ID and PIN to print or change settings.



Set up an account with full access privileges called "System Manager ID" for a system manager. Registering an account called "Department ID" allows you to manage general users. Using a Department ID, you can set a PIN for using this machine as well as keep track of the number of pages printed for each department ID. And by setting a Remote UI Access PIN, you can restrict use of the Remote UI.

### System Manager ID

---

System Manager ID is an account with full access privileges. If you specify a System Manager ID, you need to log on to the machine using the System Manager ID information in order to access items that requires administrator privileges such as <Network> and <Management Settings>. We recommend that you set and register the System Manager ID. Otherwise, anyone will be able to change the machine settings. Only one System Manager ID can be registered. [▶Setting the System Manager ID and PIN\(P. 349\)](#)

### Department ID (Department ID Management)

---

You can specify access privileges for a user (or group of users) by registering a Department ID. You can register multiple Department IDs. If a user tries to operate the machine when Department IDs are enabled, a login screen is displayed, and the user must enter their own Department ID and PIN to use the machine. Information such as how many pages have been printed for each Department ID can be compiled. [▶Setting the Department ID Management\(P. 351\)](#)

### Remote UI PIN (Remote UI Access PIN)

---

This is a PIN for using the Remote UI. Only users who know the PIN can access the Remote UI. [▶Setting a Remote UI PIN\(P. 357\)](#)

### Authentication Settings for Send Function (Authorized Send)

---

If your system has an LDAP server installed, you can set LDAP server authentication to be carried out when the fax or scan function is used. [▶LDAP Server Authentication\(P. 359\)](#)

## Setting the System Manager ID and PIN

261J-06W

Set the system manager account, "System Manager ID." You can also set a PIN for the System Manager ID. If the System Manager ID is specified, you can access items that require administrator privileges, for example, <Network> and <Management Settings>, only when the System Manager ID and PIN have been entered correctly. The System Manager ID settings information is critical to the security of the machine, so make sure that only Administrators know the System Manager ID and PIN.

**1** Select <Menu> in the Home screen. Home Screen(P. 121)

**2** Select <Management Settings>.

### NOTE:

If the System Manager ID has already been set

- If the login screen appears, enter the correct ID and PIN. Logging in to the Machine(P. 132)

**3** Select <User Management> <System Manager Information Settings>.

**4** Select <System Manager ID and PIN>.

**5** Specify the System Manager ID and PIN.

- Specify the <System Manager ID> <System Manager PIN>.
- Enter numbers for each item, and select <Apply>.
- The Confirm screen is displayed. Enter the PIN once again to confirm.

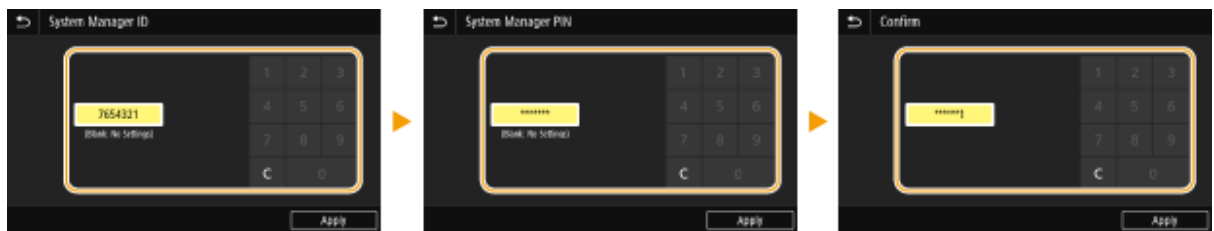

### NOTE:

- You cannot register an ID or PIN that consists only of zeros, such as "00" or "0000000."
- To cancel the System Manager ID and PIN settings, clear the information you entered in and select <Apply> with the fields blank.

### ■ Setting the System Manager Name

- 1 Select <System Manager Name>.
- 2 Enter the System Manager Name, and select <Apply>.
  - On how to enter text, see Entering Text(P. 130) .

## IMPORTANT

- Do not forget your PIN. If you forget your PIN, contact your local authorized Canon dealer or the Canon help line.

## NOTE

### Configuring settings via the Remote UI

- Start the Remote UI and log in to System Manager Mode. Click [Settings/Registration] ▶ [User Management] ▶ [System Manager Information] ▶ [Edit] and specify the necessary settings on the displayed screen.
- By using the Remote UI, you can register a variety of information, including contact information, Administrator comments, the installation location of the machine, as well as the settings that you can register by using the operation panel. The registered information can be viewed on the [Device Information] page of the Remote UI. ▶ **Checking System Manager Information(P. 421)**

### Logging in to the machine

- If you try to access items that require administrator privileges, for example, <Network> and <Management Settings>, when the System Manager ID is specified, the Login screen is displayed. ▶ **Logging in to the Machine(P. 132)**
- You must also enter the System Manager ID and PIN to log in using the Remote UI in System Manager Mode. ▶ **Starting Remote UI(P. 415)**

## LINKS

---

- ▶ **Setting Access Privileges(P. 348)**
- ▶ **Setting the Department ID Management(P. 351)**

# Setting the Department ID Management

261J-06X

You can control access to the machine by using multiple IDs for multiple users or groups. If a user tries to operate the machine when Department ID Management is enabled, a login screen is displayed, and the user must enter their own Department ID and PIN to use the machine. When Department ID Management is enabled, usage of functions, such as printing, is recorded for each Department ID. To configure Department ID Management, register department IDs as necessary and then enable Department ID Management function. When you want to enable Department ID Management for jobs from a computer, you need to configure additional settings on the computer side.

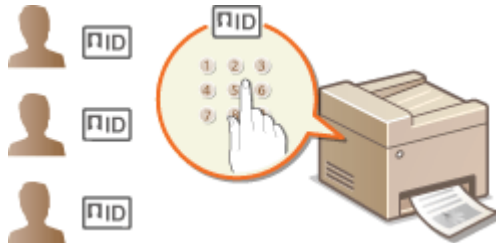

- ▶ **Registering/Editing Department ID and PIN(P. 351)**
- ▶ **Enabling the Department ID Management(P. 353)**
- ▶ **Enabling the Department ID Management for Jobs from a Computer(P. 354)**
- ▶ **Blocking Jobs When Department ID Is Unknown(P. 355)**

## NOTE

- For more information about the basic operations to be performed when setting the machine from the Remote UI, see ▶ **Setting Up Menu Options from Remote UI(P. 424)** .

## Registering/Editing Department ID and PIN

Register a Department ID and set a PIN for it. Register all the department IDs to be managed.

- 1 Start the Remote UI and log in to System Manager Mode. ▶ Starting Remote UI(P. 415)**
- 2 Click [Settings/Registration] on the Portal page. ▶ Remote UI Screen(P. 416)**
- 3 Select [User Management] ▶ [Department ID Management].**
- 4 Register or edit Department IDs.**

### ■ Registering a Department ID

- 1** Click [Register New Department].
- 2** Specify the required settings.

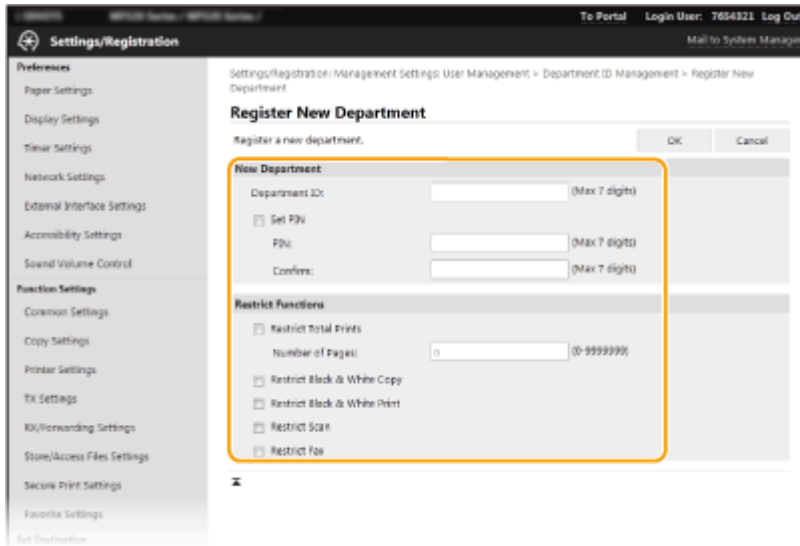

**[Department ID]**

Enter the Department ID number to be registered.

**[Set PIN]**

To set a PIN, select the check box and enter the same number both in the [PIN] and [Confirm] text boxes.

**[Restrict Functions]**

You can restrict the number of pages to print and the available functions for departments to be registered. To restrict the number of pages to print, select the check box for the target type, and enter the appropriate number of pages in [Number of Pages]. Select the check box for the target functions to restrict functions.

**NOTE:**

- If the [Restrict Scan] check box is selected, the Save to USB Memory Device, Send E-mail, and Save to Shared Folder or FTP Server functions are all restricted. You can also restrict other methods that scan documents by importing them to a computer, but in that case you cannot block access for each Department ID ( [▶Blocking Jobs When Department ID Is Unknown\(P. 355\)](#) ).

**3** Click [OK].

**■Editing the settings of the registered Department ID**

**1** Click the corresponding text link under [Department ID] to edit.

**2** Change the settings as necessary and click [OK].

**NOTE:**

**Deleting a Department ID**

- Click [Delete] on the right of the Department ID you want to delete ▶ click [OK].

**NOTE**

**[Department ID Page Total]**

- You can check the total number of pages for jobs that have been executed to date on a department ID basis.
- If you want to return the counts to zero, click the corresponding text link under [Department ID] and click [Clear Count] ▶ [OK]. If you want to return the counts of all Department IDs to zero, click [Clear All Counts] ▶ [OK].



Department ID	Page Total/Page Restriction					
	Total Points	Color	Black & White			
7654321	0	0	0	0	0	
0000001	1	0	0	0	1	Delete Clear Count
0000002	0	0	0	0	0	Delete Clear Count
Unknown ID Jobs	0	0	0	0	0	
RX Print/State Report	0	0	0	0	0	

### Using control cards

- When the optional Copy Card Reader-F is attached to the machine, Department IDs will be registered automatically.
- Do not delete the registered department IDs. The control cards that correspond to the deleted department IDs will become unavailable.
- You cannot use [Restrict Functions] to restrict the allowable number of pages to print.

## Enabling the Department ID Management

After you register as many Department IDs as necessary, enable Department ID Management.

- 1 Start the Remote UI and log in to System Manager Mode. ▶Starting Remote UI(P. 415)**
- 2 Click [Settings/Registration] on the Portal page. ▶Remote UI Screen(P. 416)**
- 3 Select [User Management] ▶ [Department ID Management].**
- 4 Click [Edit].**
- 5 Select the [Department ID Management] check box.**

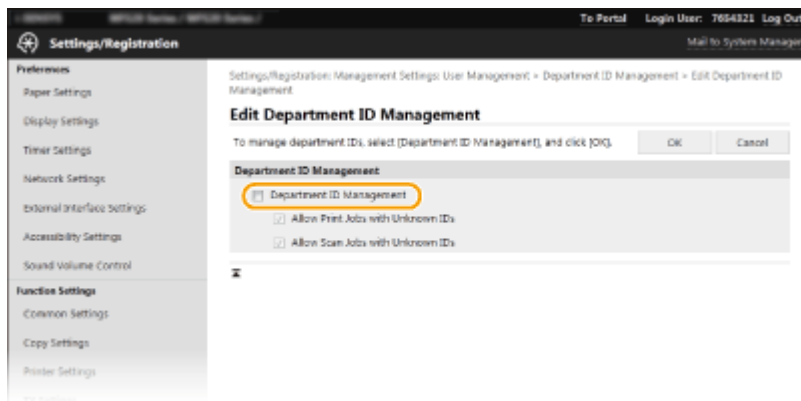

#### [Department ID Management]

Select the check box to enable Department ID Management. If you do not want to use Department ID Management, clear the check box.

### NOTE:

- For information about the [Allow Print Jobs with Unknown IDs]/[Allow Scan Jobs with Unknown IDs] check boxes, see ▶**Blocking Jobs When Department ID Is Unknown(P. 355)** .

## 6 Click [OK].

### NOTE

#### Using the operation panel

- Department ID Management settings can also be accessed from <Menu> in the Home Screen. ▶  
**<Department ID Management>(P. 545)**

#### Logging in to the machine

- When you try to operate the machine when Department ID Management is enabled, the login screen is displayed. ▶**Logging in to the Machine(P. 132)**

## Enabling the Department ID Management for Jobs from a Computer

When you want to enable Department ID Management for jobs from a computer, you need to specify the department ID and PIN using the driver pre-installed on each computer.

### IMPORTANT

- To perform the following procedure, log in to your computer with an administrator account.

- 1 Open the printer folder. ▶**Displaying the Printer Folder(P. 698)**
- 2 Right-click the driver icon for this machine, and click [Printer properties] or [Properties].
- 3 Click the [Device Settings] tab.
- 4 Select [Department ID Management] under [User Management].
- 5 Click [Settings] found to the right.
- 6 Specify the settings as necessary and click [OK].

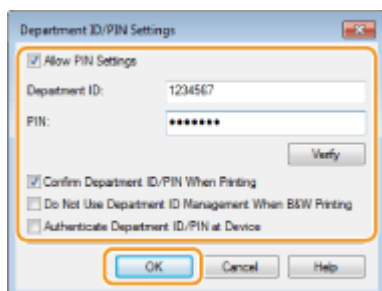

[Allow PIN Setting]

Select the check box to enable the PIN setting.

**[Department ID]**

Enter the Department ID number.

**[PIN]**

Enter the PIN corresponding to the Department ID as necessary.

**[Verify]**

Click to verify that the correct ID and PIN are entered. This function is not available if the machine and the computer are connected via a USB or WSD (Web Services on Devices) port.

**[Confirm Department ID/PIN When Printing]/[Confirm Department ID/PIN When Sending Faxes]**

Select the check box to display the [Confirm Department ID/PIN] pop-up screen each time you send job from a computer.

**[Authenticate Department ID/PIN at Device]**

Select the check box if the machine and the computer are connected via a USB or WSD port.

**7 Click [OK].**

**NOTE**

**Logging in to the machine**

- When you try to send job from a computer when Department ID Management is enabled, the following pop-up screen is displayed (unless the [Confirm Department ID/PIN When Printing]/[Confirm Department ID/PIN When Sending Faxes] check box is cleared):

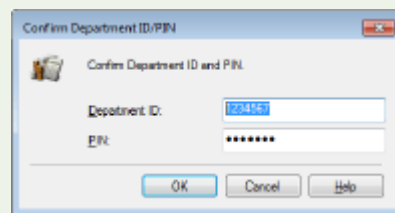

**Blocking Jobs When Department ID Is Unknown**

If you do not change the default settings, any user can print from a computer, scan (via <Computer> and <Remote Scanner>) or send a PC fax from a computer without entering an ID and PIN even when Department ID Management is enabled for the machine. You can change the default settings so that the machine cannot be used for these functions without a correct ID and PIN.

- 1 Start the Remote UI and log in to System Manager Mode. ▶ Starting Remote UI(P. 415)**
- 2 Click [Settings/Registration] on the Portal page. ▶ Remote UI Screen(P. 416)**
- 3 Select [User Management] ▶ [Department ID Management].**
- 4 Click [Edit].**
- 5 Clear the check boxes as necessary.**

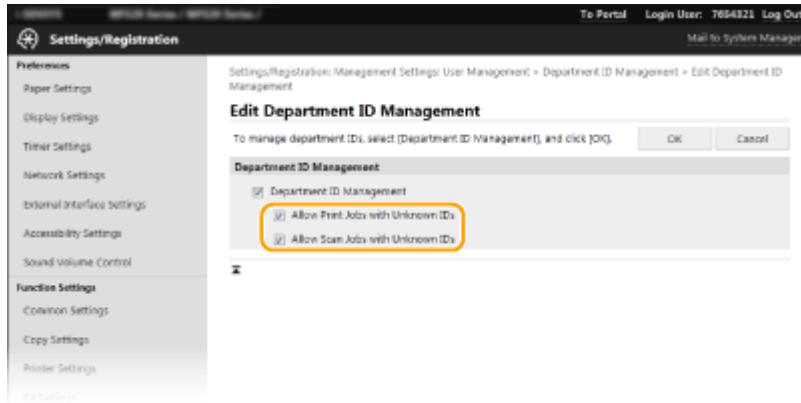

**[Allow Print Jobs with Unknown IDs]**

In order to send job from a computer when Department ID Management is enabled, you need to enter the correct ID and PIN ( **▶Enabling the Department ID Management for Jobs from a Computer(P. 354)** ). However, if the check box is selected for this setting, jobs are executed even when the ID and PIN are not entered. When you want to configure a setting so that no jobs are executed unless the correct department ID and PIN are entered, clear the check box.

**[Allow Scan Jobs with Unknown IDs]**

If the check box is selected, you can select <Computer> or <Remote Scanner> on the main screen and scan documents into a computer anytime. If the check box is cleared, you cannot scan documents into a computer if Department ID Management is enabled. It is not possible to restrict scanning of documents into a computer for individual department IDs.

**6 Click [OK].**

LINKS

- ▶Setting Access Privileges(P. 348)
- ▶Setting the System Manager ID and PIN(P. 349)

## Setting a Remote UI PIN

261J-06Y

You can set a PIN for access to the Remote UI. All users use a common PIN.

### NOTE

- When Department ID Management is enabled, setting here is not required. [▶Setting the Department ID Management\(P. 351\)](#)
- For more information about the basic operations to be performed when setting the machine from the Remote UI, see [▶Setting Up Menu Options from Remote UI\(P. 424\)](#) .

- 1 Start the Remote UI and log in to System Manager Mode. [▶Starting Remote UI\(P. 415\)](#)**
- 2 Click [Settings/Registration] on the Portal page. [▶Remote UI Screen\(P. 416\)](#)**
- 3 Select [License/Other] ▶ [Remote UI Settings].**
- 4 Click [Edit].**
- 5 Select the [Use Remote UI Access PIN] check box and set the PIN.**

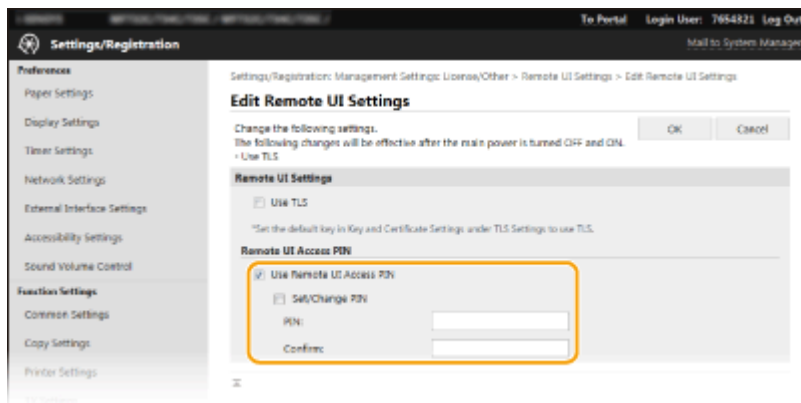

#### [Use Remote UI Access PIN]

If you select the check box, you must enter a PIN to access the Remote UI.

#### [Set/Change PIN]

To set or change a PIN, select the check box and enter the same number both in the [PIN] and [Confirm] text boxes.

- 6 Click [OK].**

### NOTE

### Using the operation panel

- Remote UI Access PIN settings can also be accessed from <Menu> in the Home screen. ▶<Remote UI Settings>(P. 550)

### If <Management Settings> are initialized

- The Remote UI Access PIN is also initialized. After an initialization, reset the PIN. ▶<Initialize Menu>(P. 553)

### LINKS

---

- ▶<Setting Access Privileges>(P. 348)
- ▶<Setting the System Manager ID and PIN>(P. 349)

# LDAP Server Authentication

261J-070

If your system has an LDAP server installed, you can ensure that LDAP server authentication is carried out when the send function is used. This enables you to prevent unauthorized use by third parties and information disclosure. Once the authorization settings are enabled, the Authorized Send screen appears when the fax or scan function is used and operation can only continue if it is correctly authorized by the LDAP server. Use the settings described here to configure LDAP server authentication. For more information about registering the server to be used for authentication, see [Registering LDAP Servers\(P. 64\)](#) .

## NOTE

- For more information about the basic operations to be performed when setting the machine from the Remote UI, see [Setting Up Menu Options from Remote UI\(P. 424\)](#) .

- 1 Start the Remote UI and log in to System Manager Mode. [Starting Remote UI\(P. 415\)](#)
- 2 Click [Settings/Registration] on the Portal page. [Remote UI Screen\(P. 416\)](#)
- 3 Select [TX Settings] ▶ [Authentication Settings for Send Function].
- 4 Click [Edit].
- 5 Select the [Use User Authentication] check box and select whether a confirmation screen is displayed at logout.

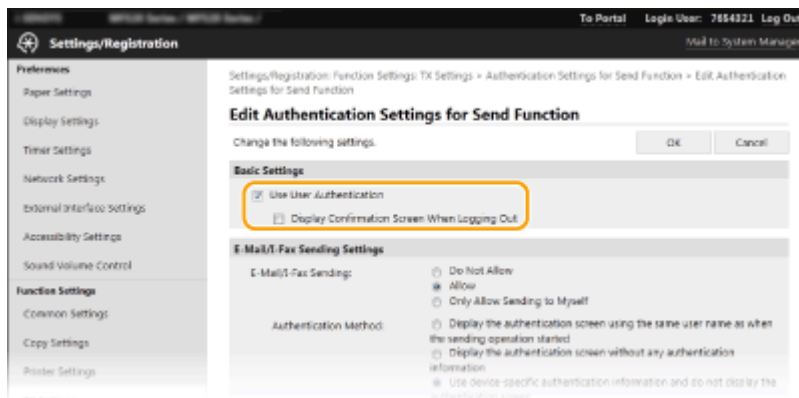

### [Use User Authentication]

Select the check box to display the Authorized Send login screen when the fax or scan function is used (LDAP server authentication).

### [Display Confirmation Screen When Logging Out]

Select the check box to display a screen that allows you to selectively log out when you are logged on for both Authorized Send and Department ID Management. If you clear this check box, no selection screen is displayed when you log out and you are logged out from both Authorized Send and Department ID Management.

## 6 Configure the settings for sending e-mail/I-Faxes.

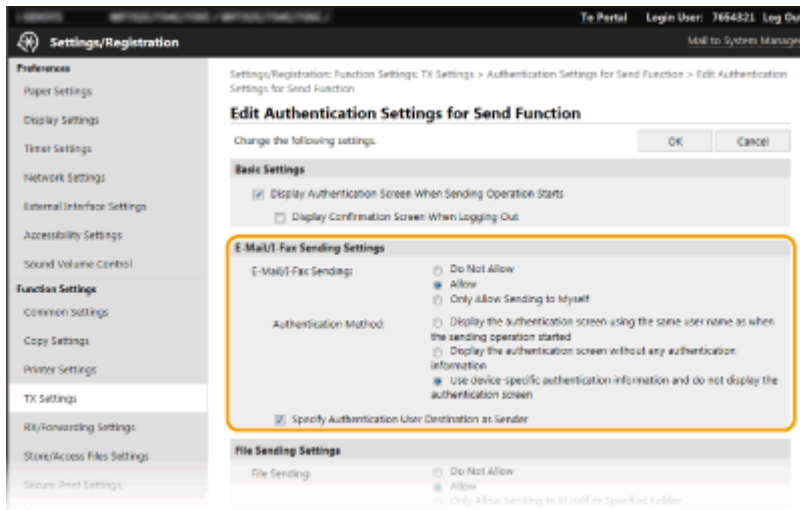

### [E-Mail/I-Fax Sending]

Select whether to allow sending e-mail and I-Faxes.

[Do Not Allow]	Blocks sending e-mail and I-Faxes. <E-Mail> and <I-Fax> in the scan function can no longer be used.
[Allow]	Permits outgoing e-mail and I-Faxes.
[Only Allow Sending to Myself]	Blocks all outgoing e-mail and I-Faxes other than those to users with authorized e-mail addresses. The e-mail addresses of authorized users must be registered on the LDAP server.

### [Authentication Method]

When [Allow] or [Only Allow Sending to Myself] is selected in [E-Mail/I-Fax Sending], this allows you to specify whether an authentication screen is shown on the SMTP server when e-mail is sent.

[Display the authentication screen using the same user name as when the sending operation started]	Displays the authentication screen showing the same user name and password entered in the Authorized Send login screen.
[Display the authentication screen without any authentication information]	Displays the authentication screen with the user name and password fields blank.
[Use device-specific authentication information and do not display the authentication screen]	No authentication screen is displayed when e-mail or I-Faxes are sent. Authorization on the SMTP server is carried out using the user name and password set in [E-Mail/I-Fax Settings]  <b>Configuring E-Mail/I-Fax Communication Settings(P. 90)</b> .

### [Specify Authentication User Destination as Sender]

Select the check box when the e-mail address of an authorized user will be set as the sender. The e-mail addresses of authorized users must be registered on the LDAP server. If you clear this check box, the e-mail address set in the [E-Mail/I-Fax Settings] is set as the sender.

## 7 Configure the file transfer settings (for saving to shared folders and FTP servers).



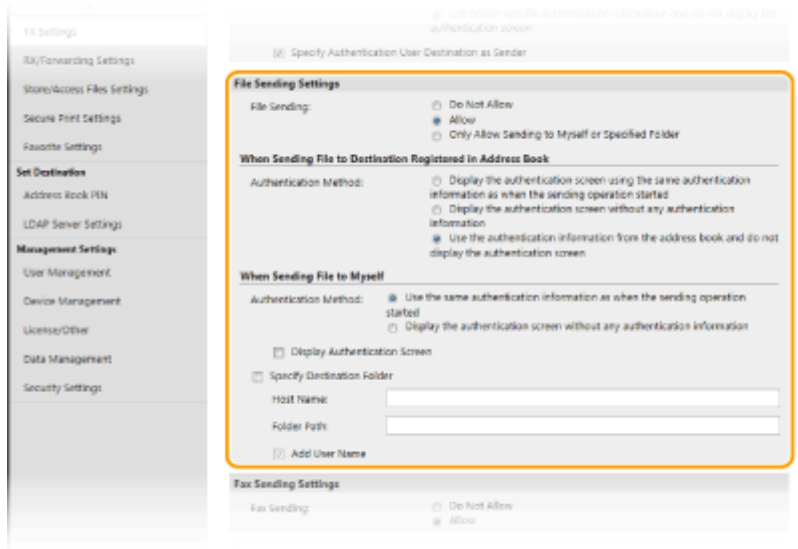

**[File Sending]**

Select whether to allow saving to shared folders and FTP servers.

[Do Not Allow]	Blocks saving to shared folders and FTP servers. <File> in the scan function can no longer be used.
[Allow]	Saving to shared folders and FTP servers is not blocked.
[Only Allow Sending to Myself or Specified Folder]	Blocks all saving to shared folders and FTP servers other than specified folders. The data is saved to folders registered on the LDAP server or to the folder specified in [Specify Destination Folder].

**■When [Allow] is specified in [File Sending]**

**[Authentication Method]**

Allows you to specify whether an authentication screen is shown on the server when sending.

[Display the authentication screen using the same authentication information as when the sending operation started]	Displays the authentication screen showing the same user name and password entered in the Authorized Send login screen.
[Display the authentication screen without any authentication information]	Displays the authentication screen with the user name and password fields blank.
[Use the authentication information from the address book and do not display the authentication screen]	No authentication screen is displayed when sending. Authentication is carried out on the server using the user name and password set in the Address Book.

**■When [Only Allow Sending to Myself or Specified Folder] is specified in [File Sending]**

**[Authentication Method]**

Allows you to specify whether an authentication screen is shown on the server when sending.

[Use the same authentication information as when the sending operation started]	Carries out authorization on the server using the user name and password entered in the Authorized Send login screen. Selecting the [Display Authentication Screen] check box displays the authentication screen with this user name and password already entered when you send the data.
[Display the authentication screen without any authentication information]	Displays the authentication screen with the user name and password fields blank.

**[Specify Destination Folder]**

Selecting this check box allows you to specify the folder where the data is saved. If the check box is not selected, the save destination is set based on authorized user information registered on the LDAP server.

[Host Name]	Enter a host name for the shared folder or FTP server.
[Folder Path]	Enter a path name for the save destination folder (excluding the host name). When the [Add User Name] check box is selected, the user name used for authentication on the LDAP server is added to the path.

**8 Configure the settings for sending faxes.**

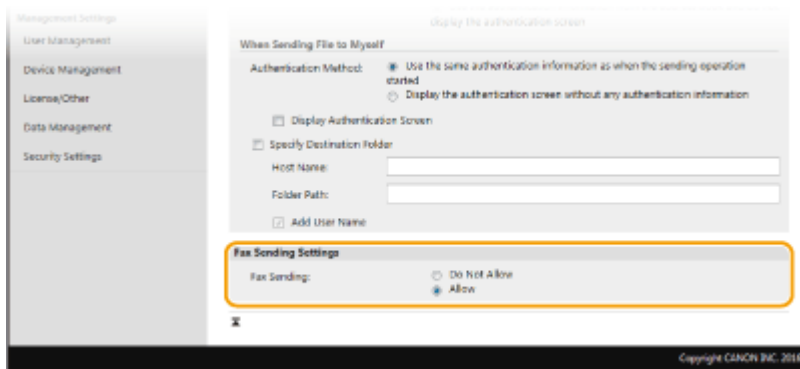

**[Fax Sending]**

Select whether to allow sending faxes. [Do Not Allow] prevents the user from sending faxes from the machine.

**9 Click [OK].**

**LINKS**

- ▶ **Registering LDAP Servers(P. 64)**

## Configuring the Network Security Settings

261J-071

Authorized users may incur unanticipated losses from attacks by malicious third parties, such as sniffing, spoofing, and tampering of data as it flows over a network. To protect your important and valuable information from these attacks, the machine supports the following features to enhance security and secrecy.

### Firewall Settings

Unauthorized access by third parties, as well as network attacks and intrusions, can be blocked by limiting communication only to devices that have a specific IP address or MAC address. **▶Restricting Communication by Using Firewalls(P. 365)**



### Changing Port Numbers

A protocol that is used to exchange information with other devices is assigned port numbers that are predetermined according to the type of protocol. The port number must be the same for all communication devices; therefore, changing it to an arbitrary number is important to prevent hacking from outside. **▶ Changing Port Numbers(P. 372)**

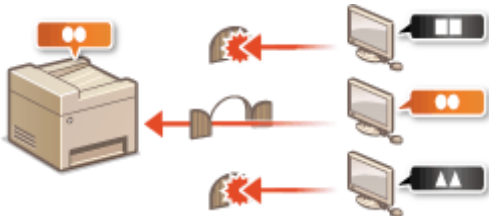

### Proxy Settings

When the client devices are connected to an external network, communication is established through the proxy server. When the proxy server is used, websites can be browsed more safely, therefore, security can be expected to be enhanced. **▶Setting a Proxy(P. 374)**



### TLS Encrypted Communication

TLS is a protocol for encryption for data sent over a network and is often used for communication via a Web browser or an e-mail application. TLS enables secure network communication when you access the machine from a computer via the Remote UI. **▶Configuring the Key and Certificate for TLS(P. 376)**



### IPSec Communication

While TLS only encrypts data used on a specific application, such as a Web browser or an e-mail application, IPSec encrypts the whole (or payloads of) IP packets. This enables IPSec to offer a more versatile security system than TLS. **🔗Configuring IPSec Settings(P. 387)**

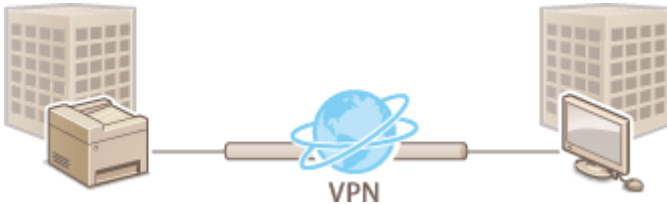

### IEEE 802.1X Authentication

IEEE 802.1X is a standard and mechanism for blocking unauthorized access to the network by collectively managing user authentication information. If a device tries to connect to the 802.1X network, the device must go through user authentication in order to prove that the connection is made by an authorized user. Authentication information is sent to and checked by a RADIUS server, which permits or rejects communication to the network depending on the authentication result. If authentication fails, a LAN switch (or an access point) blocks access from the outside of the network. The machine can connect to an 802.1X network as a client device. **🔗Configuring IEEE 802.1X Authentication Settings(P. 394)**

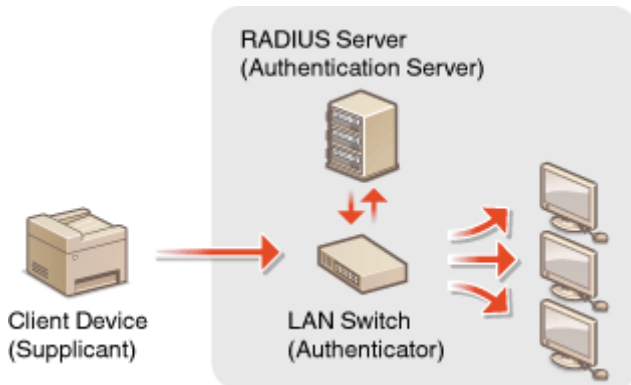

## Restricting Communication by Using Firewalls

261J-072

Without proper security, unauthorized third parties can access computers and other communication devices that are connected to a network. To prevent this unauthorized access, specify the settings for packet filter, a feature that restricts communication to devices with specified IP addresses or MAC addresses.

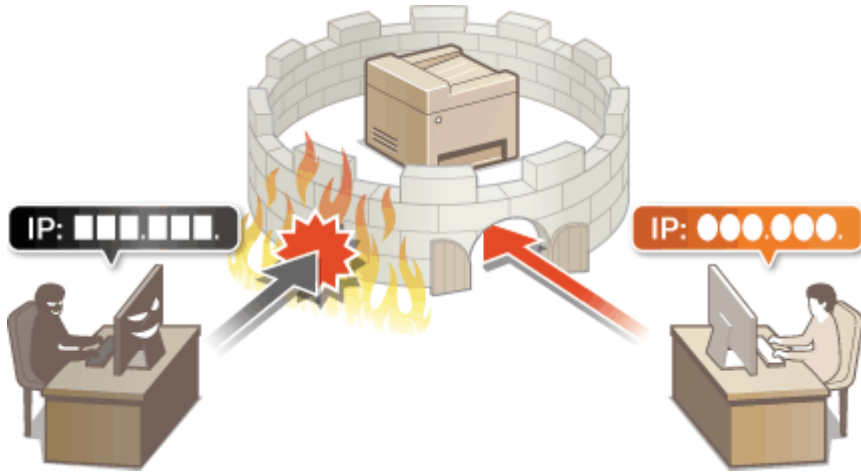

- [Specifying IP Addresses for Firewall Settings\(P. 366\)](#)
- [Specifying MAC Addresses for Firewall Settings\(P. 369\)](#)

# Specifying IP Addresses for Firewall Settings

261J-073

You can either limit communication to only devices with specified IP addresses, or block devices with specified IP addresses but permit other communications. You can specify a single IP address or a range of IP addresses.

## NOTE

- For more information about the basic operations to be performed when setting the machine from the Remote UI, see [▶Setting Up Menu Options from Remote UI\(P. 424\)](#) .

**1 Start the Remote UI and log in to System Manager Mode. ▶Starting Remote UI(P. 415)**

**2 Click [Settings/Registration] on the Portal page. ▶Remote UI Screen(P. 416)**

**3 Select [Network Settings] ▶ [Firewall Settings].**

**4 Click [Edit] for the target IP address filter.**

- Select the filter that matches the target IP address. To restrict data sent from the machine to a computer, select [Outbound Filter]. To restrict data received from a computer, select [Inbound Filter].

**5 Specify the settings for packet filtering.**

- Select the default policy to allow or reject the communication of other devices with the machine, and then specify IP addresses for exceptions.

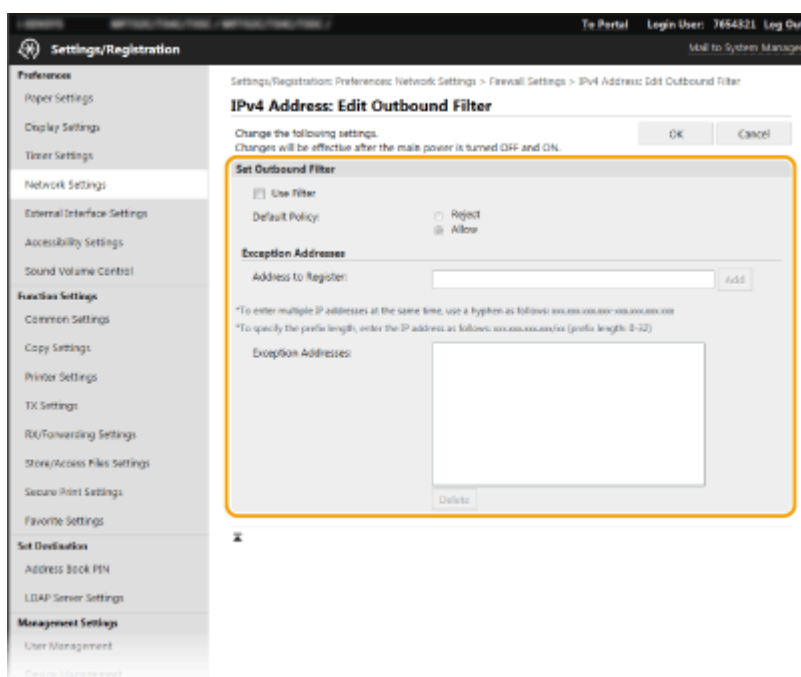

- 1 Select the [Use Filter] check box and click the [Reject] or [Allow] radio button for the [Default Policy].

**[Use Filter]**

Select the check box to restrict communication. Clear the check box to disable the restriction.

**[Default Policy]**

Select the precondition to allow or reject the communication of other devices with the machine.

[Reject]	Select to pass communication packets only when they are sent to or received from devices whose IP addresses are entered in [Exception Addresses]. Communications with other devices are prohibited.
[Allow]	Select to block communication packets when they are sent to or received from devices whose IP addresses are entered in [Exception Addresses]. Communications with other devices are permitted.

- 2 Specify address exceptions.

- Enter the IP address (or the range of IP addresses) in the [Address to Register] text box and click [Add].

**IMPORTANT:**

**Check for entry errors**

- If IP addresses are incorrectly entered, you may be unable to access the machine from the Remote UI, in which case you need to set <IPv4 Address Filter> or <IPv6 Address Filter> to <Off>.
  - ▶<IPv4 Address Filter>(P. 469)
  - ▶<IPv6 Address Filter>(P. 469)

**NOTE:**

**Entry form for IP addresses**

	Description	Example
Entering a single address	<b>IPv4:</b> Delimit numbers with periods.	192.168.0.10
	<b>IPv6:</b> Delimit alphanumeric characters with colons.	fe80::10
Specifying a range of addresses	Insert a hyphen between the addresses.	192.168.0.10-192.168.0.20
Specifying a range of addresses with a prefix	Enter the address, followed by a slash and a number indicating the prefix length.	192.168.0.32/27 fe80::1234/64

**When [Reject] is selected for an outbound filter**

- Outgoing multicast and broadcast packets cannot be filtered.

**Deleting an IP address from exceptions**

- Select an IP address and click [Delete].

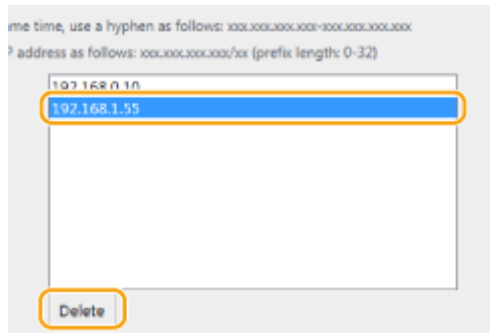

**3** Click [OK].

## **6** Restart the machine.

- Turn OFF the machine, wait for at least 10 seconds, and turn it back ON.

## **NOTE**

### Using the operation panel

- You can also enable or disable IP address filtering from <Menu> in the Home screen.
  - ▶<IPv4 Address Filter>(P. 469)
  - ▶<IPv6 Address Filter>(P. 469)

## LINKS

---

- ▶Specifying MAC Addresses for Firewall Settings(P. 369)



# Specifying MAC Addresses for Firewall Settings

261J-074

You can limit communication to only devices with specified MAC addresses, or block devices with specified MAC addresses but permit other communications.

## IMPORTANT

This function is unavailable when the machine is connected to a wireless LAN.

## NOTE

- For more information about the basic operations to be performed when setting the machine from the Remote UI, see [▶Setting Up Menu Options from Remote UI\(P. 424\)](#) .

- 1 Start the Remote UI and log in to System Manager Mode.** [▶Starting Remote UI\(P. 415\)](#)
- 2 Click [Settings/Registration] on the Portal page.** [▶Remote UI Screen\(P. 416\)](#)
- 3 Select [Network Settings] ▶ [Firewall Settings].**
- 4 Click [Edit] for the target MAC address filter.**
  - To restrict data sent from the machine to a computer, select [Outbound Filter]. To restrict data received from a computer, select [Inbound Filter].
- 5 Specify the settings for packet filtering.**
  - Select the precondition (default policy) to allow or reject the communication of other devices with the machine, and then specify MAC addresses for exceptions.

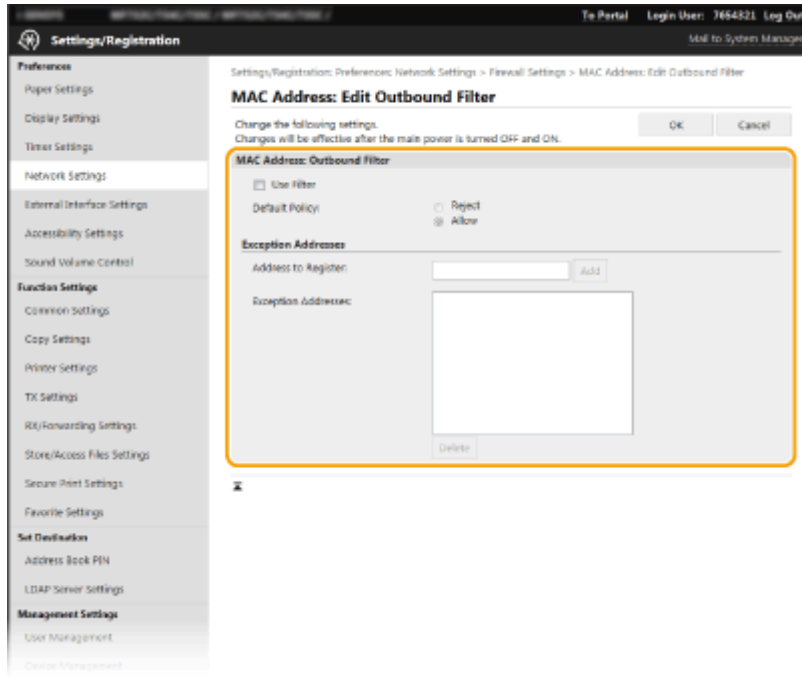

- 1 Select the [Use Filter] check box and click the [Reject] or [Allow] radio button for the [Default Policy].

**[Use Filter]**

Select the check box to restrict communication. Clear the check box to disable the restriction.

**[Default Policy]**

Select the precondition to allow or reject other devices to communicate with the machine.

[Reject]	Select to pass communication packets only when they are sent to or received from devices whose MAC addresses are entered in [Exception Addresses]. Communications with other devices are prohibited.
[Allow]	Select to block communication packets when they are sent to or received from devices whose MAC addresses are entered in [Exception Addresses]. Communications with other devices are permitted.

- 2 Specify address exceptions.
  - Enter the MAC address in the [Address to Register] text box and click [Add].
  - You do not need to delimit the address with hyphens or colons.

**IMPORTANT:**

**Check for entry errors**

- If MAC addresses are incorrectly entered, you may become unable to access the machine from the Remote UI, in which case you need to set <MAC Address Filter> to <Off>. **<MAC Address Filter>(P. 469)**

**NOTE:**

**When [Reject] is selected for an outbound filter**

- Outgoing multicast and broadcast packets cannot be filtered.

**Deleting a MAC address from exceptions**

- Select a MAC address and click [Delete].

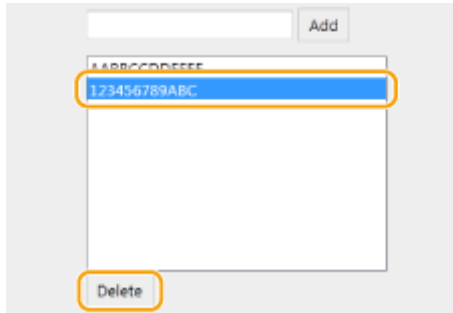

3 Click [OK].

## 6 Restart the machine.

- Turn OFF the machine, wait for at least 10 seconds, and turn it back ON.

## NOTE

### Using the operation panel

- You can also enable or disable MAC address filtering from <Menu> in the Home screen. [▶<MAC Address Filter>\(P. 469\)](#)

## LINKS

---

[▶Specifying IP Addresses for Firewall Settings\(P. 366\)](#)

# Changing Port Numbers

261J-075

Ports serve as endpoints for communicating with other devices. Typically, conventional port numbers are used for major protocols, but devices that use these port numbers are vulnerable to attacks because these port numbers are well-known. To enhance security, your Network Administrator may change the port numbers. When a port number has been changed, the new number must be shared with the communicating devices, such as computers and servers. Specify the port number settings depending on the network environment.

## NOTE

- To change the port number for proxy server, see [▶Setting a Proxy\(P. 374\)](#) .
- To change the port number for LDAP server, see [▶Registering LDAP Servers\(P. 64\)](#) .

**1** Select <Menu> in the Home screen. [▶Home Screen\(P. 121\)](#)

**2** Select <Preferences> ▶ <Network>.

- If the login screen appears, enter the correct ID and PIN. [▶Logging in to the Machine\(P. 132\)](#)

**3** Select <TCP/IP Settings> ▶ <Port Number Settings>.

**4** Selecting the protocol of which you want to change the port number.

## NOTE:

### Learning more about the protocols

- <LPD>/<RAW>/<WSD Multicast Discovery> [▶Configuring Printing Protocols and WSD Functions\(P. 41\)](#)
- <HTTP> [▶Disabling HTTP Communication\(P. 410\)](#)
- <POP3>/<SMTP> [▶Configuring E-Mail/I-Fax Communication Settings\(P. 90\)](#)
- <SNMP> [▶Monitoring and Controlling the Machine with SNMP\(P. 69\)](#)
- <Multicast Discovery> [▶Monitoring the Machine from the Device Management Systems\(P. 74\)](#)
- <FTP> [▶Procedure for Setting a FTP Server as a Save Location\(P. 98\)](#)

**5** Enter the port number, and select <Apply>.

**6** Select <OK>.

**7** Restart the machine.

- Turn OFF the machine, wait for at least 10 seconds, and turn it back ON.

## LINKS

▶ **Configuring Printer Ports(P. 44)**

# Setting a Proxy

261J-076

A proxy (or HTTP proxy server) refers to a computer or software that carries out HTTP communication for other devices, especially when communicating with resources outside the network, such as when browsing Web sites. The client devices connect to the outside network through the proxy server, and do not communicate directly to the resources outside. Setting a proxy not only facilitates management of traffic between in-house and outside networks but also blocks unauthorized access and consolidates anti-virus protection for enhanced security. When you use Google Cloud Print to print over the Internet, you can enhance security by setting a proxy. When setting a proxy, make sure that you have the necessary proxy information, including the IP address, port number, and a user name and password for authentication.

## NOTE

- For more information about the basic operations to be performed when setting the machine from the Remote UI, see [▶Setting Up Menu Options from Remote UI\(P. 424\)](#) .

- 1 Start the Remote UI and log in to System Manager Mode. ▶Starting Remote UI(P. 415)**
- 2 Click [Settings/Registration] on the Portal page. ▶Remote UI Screen(P. 416)**
- 3 Select [Network Settings] ▶ [Proxy Settings].**
- 4 Click [Edit].**
- 5 Select the [Use Proxy] check box and specify the required settings.**

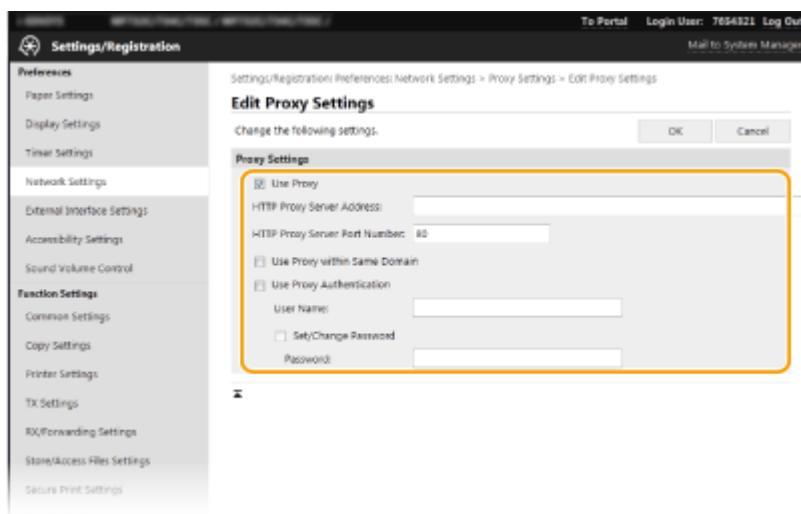

### [Use Proxy]

Select the check box to use the specified proxy server when communicating with an HTTP server.

### [HTTP Proxy Server Address]

Enter the address of the proxy server. Specify the IP address or host name depending on the environment.

### [HTTP Proxy Server Port Number]

Change the port number as necessary.

**[Use Proxy within Same Domain]**

Select the check box to also use the specified proxy server for communication with devices in the same domain.

**[Use Proxy Authentication]**

To enable authentication by the proxy server, select the check box and enter alphanumeric characters for the user name in the [User Name] text box.

**[Set/Change Password]**

To set or change the password for the proxy authentication, when it is enabled, select the check box and enter alphanumeric characters for the new password in the [Password] text box.

**6 Click [OK].**

**LINKS**

---

**▶ Using Google Cloud Print(P. 341)**

## Configuring the Key and Certificate for TLS

261J-077

You can encrypt communication between the machine and a Web browser on the computer by using Transport Layer Security (TLS). TLS is a mechanism for encrypting data sent or received over the network. TLS must be enabled when the Remote UI is used for specifying settings for IPSec (Pre-Shared Key Method), IEEE 802.1X authentication (TTLS/PEAP), or SNMPv3. To use TLS encrypted communication for the Remote UI, you need to specify a "key and certificate" (server certificate) you want to use before enabling TLS. Generate or install the key and certificate for TLS before enabling TLS ( [▶Management Functions\(P. 682\)](#) ).



### NOTE

- For more information about the basic operations to be performed when setting the machine from the Remote UI, see [▶Setting Up Menu Options from Remote UI\(P. 424\)](#) .

- 1** Start the Remote UI and log in to System Manager Mode. [▶Starting Remote UI\(P. 415\)](#)
- 2** Click [Settings/Registration] on the Portal page. [▶Remote UI Screen\(P. 416\)](#)
- 3** Select [Network Settings] ▶ [TLS Settings].
- 4** Click [Key and Certificate].
- 5** Click [Register Default Key] on the right of the key and certificate you want to use.

### NOTE:

#### Viewing details of a certificate

- You can check the details of the certificate or verify the certificate by clicking the corresponding text link under [Key Name], or the certificate icon.

- 6** Select [License/Other] ▶ [Remote UI Settings].



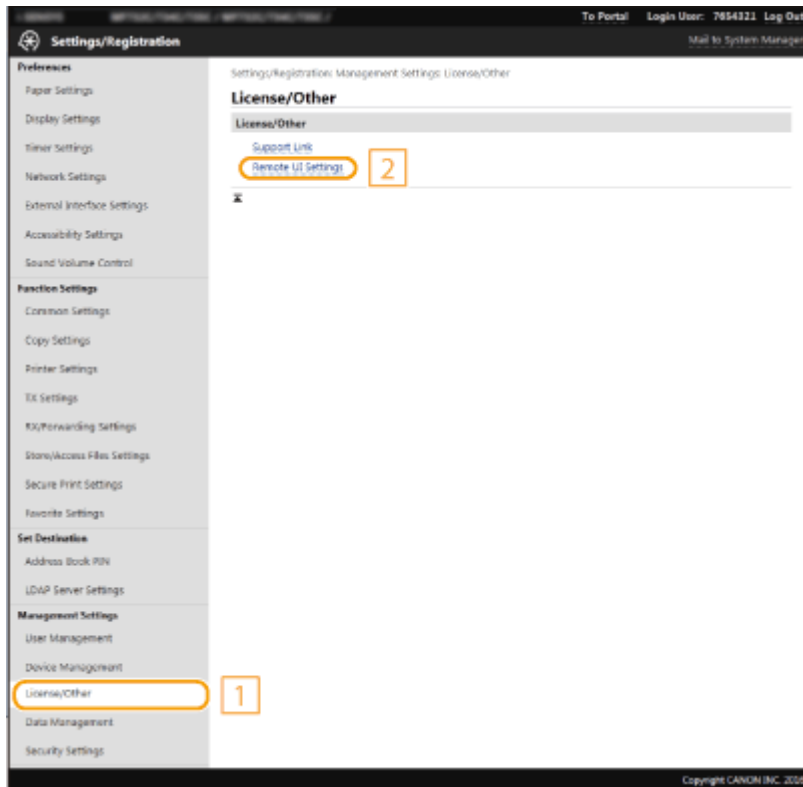

**7** Click [Edit].

**8** Select the [Use TLS] check box and click [OK].

**9** Restart the machine.

- Turn OFF the machine, wait for at least 10 seconds, and turn it back ON.

## NOTE

### Using the operation panel

- You can also enable or disable TLS encrypted communication from <Menu> in the Home screen. ▶<Remote UI>(P. 550)

### Starting the Remote UI with TLS

- If you try to start the Remote UI when TLS is enabled, a security alert may be displayed regarding the security certificate. In this case, check that the correct URL is entered in the address field, and then proceed to display the Remote UI screen. ▶Starting Remote UI(P. 415)

### Using TLS to encrypt e-mail/I-Fax communication

- If the SMTP server and the POP3 server support TLS, you can enable TLS for communication with these servers ( ▶Configuring E-Mail/I-Fax Communication Settings(P. 90) ). For more information about the SMTP server and the POP3 server, contact your Internet service provider or Network Administrator.

### Limiting the TLS version

- Select [Allowed Versions] on the [TLS Settings] page of Remote UI, and specify the upper limit and lower limit.

## LINKS

---

- ▶ **Generating the Key and Certificate for Network Communication(P. 379)**
- ▶ **Generating a Key and Certificate Signing Request (CSR)(P. 382)**
- ▶ **Registering the Key and Certificate for Network Communication(P. 385)**
- ▶ **Configuring IPSec Settings(P. 387)**
- ▶ **Configuring IEEE 802.1X Authentication Settings(P. 394)**
- ▶ **Monitoring and Controlling the Machine with SNMP(P. 69)**
- ▶ **Registering LDAP Servers(P. 64)**

# Generating the Key and Certificate for Network Communication

261J-078

A key and certificate can be generated with the machine when it is required for encrypted communication via Transport Layer Security (TLS). You can use TLS when accessing the machine via the Remote UI. Self-signed certificates are used with the key and certificate generated in "Network Communication."

## NOTE

- If you want to use a server certificate that has a CA signature, you can generate a CSR together with a key instead of a certificate. ▶ [Generating a Key and Certificate Signing Request \(CSR\)\(P. 382\)](#)
- For more information about the basic operations to be performed when setting the machine from the Remote UI, see ▶ [Setting Up Menu Options from Remote UI\(P. 424\)](#) .

- 1 Start the Remote UI and log in to System Manager Mode.** ▶ [Starting Remote UI\(P. 415\)](#)
- 2 Click [Settings/Registration] on the Portal page.** ▶ [Remote UI Screen\(P. 416\)](#)
- 3 Select [Device Management] ▶ [Key and Certificate Settings].**
- 4 Click [Generate Key].**

## NOTE:

### Deleting a registered key and certificate

- Click [Delete] on the right of the key and certificate you want to delete ▶ click [OK].
- A key and certificate cannot be deleted if it is currently used for some purpose, such as when "[TLS]" or "[IEEE 802.1X]" is displayed under [Key Usage]. In this case, disable the function or replace the other key and certificate before deleting it.

- 5 Select [Network Communication] and click [OK].**
- 6 Specify settings for the key and certificate.**

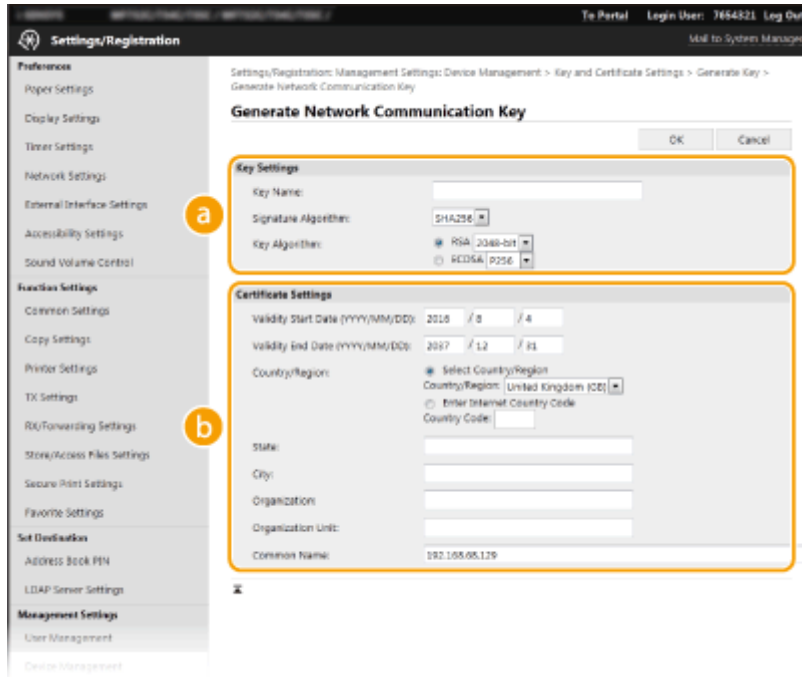

**a [Key Settings]**

**[Key Name]**

Enter alphanumeric characters for naming the key. Set a name that will be easy for you to find later in a list.

**[Signature Algorithm]**

Select the signature algorithm from the drop-down list.

**[Key Algorithm]**

Select the key generation algorithm from [RSA] or [ECDSA], then select the key length from the drop-down list. In either case, the larger the number for the key length is, the higher the security level becomes. However, the communication speed becomes slower.

**NOTE:**

- When [SHA384] or [SHA512] is selected in [Signature Algorithm], [512-bit] cannot be selected as the key length when [RSA] is selected in [Key Algorithm].

**b [Certificate Settings]**

**[Validity Start Date (YYYY/MM/DD)]**

Enter the validity start date of the certificate, in the order of: year, month, day.

**[Validity End Date (YYYY/MM/DD)]**

Enter the validity end date of the certificate, in the order of: year, month, day. A date earlier than [Validity Start Date (YYYY/MM/DD)] cannot be set.

**[Country/Region]**

Click the [Select Country/Region] radio button and select the country/region from the drop-down list. You can also click the [Enter Internet Country Code] radio button and enter a country code, such as "US" for the United States.

**[State]/[City]**

Enter alphanumeric characters for the location as necessary.

**[Organization]/[Organization Unit]**

Enter alphanumeric characters for the organization name as necessary.

**[Common Name]**

Enter alphanumeric characters for the common name of the certificate as necessary. "Common Name" is often abbreviated as "CN."

## 7 Click [OK].

- Generating a key and certificate may take some time.
- After the key and certificate is generated, it is automatically registered to the machine.

### LINKS

---

- ▶ **Registering the Key and Certificate for Network Communication(P. 385)**
- ▶ **Configuring the Key and Certificate for TLS(P. 376)**
- ▶ **Configuring IPSec Settings(P. 387)**

# Generating a Key and Certificate Signing Request (CSR)

261J-079

Because certificates generated on the machine do not have a CA signature, a communication error may result depending on devices it communicates with. To have the certificate authority issue the certificate with the CA signature, you need to obtain data of CSR (Certificate Signing Request), which the administrator can generate from Remote UI. When the certificate is issued, register it in the key with the CSR generated.

▶ **Generating a Key and CSR(P. 382)**

▶ **Registering a Certificate to a Key(P. 384)**

## NOTE

- For more information about the basic operations to be performed when setting the machine from the Remote UI, see ▶ **Setting Up Menu Options from Remote UI(P. 424)** .

## Generating a Key and CSR

- 1 Start the Remote UI and log in to System Manager Mode.** ▶ **Starting Remote UI(P. 415)**
- 2 Click [Device Management] on the Portal page.** ▶ **Remote UI Screen(P. 416)**
- 3 Select [Device Management] ▶ [Key and Certificate Settings].**
- 4 Click [Generate Key].**

### NOTE:

#### Deleting a registered key and certificate

- Click [Delete] on the right of the key and certificate you want to delete ▶ click [OK].
- A key and certificate cannot be deleted if it is currently used for some purpose, such as when "[TLS]" or "[IEEE 802.1X]" is displayed under [Key Usage]. In this case, disable the function or replace the key and certificate before deleting it.

- 5 Select [Key and Certificate Signing Request (CSR)] and click [OK].**
- 6 Specify settings for the key and CSR.**

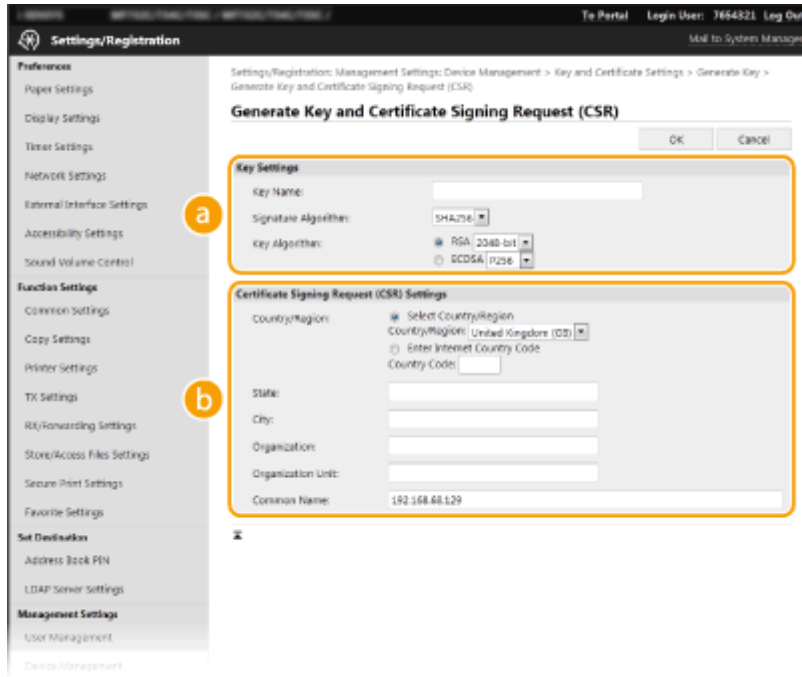

**a [Key Settings]**

**[Key Name]**

Enter alphanumeric characters for naming the key. Set a name that will be easy for you to find later in a list.

**[Signature Algorithm]**

Select the signature algorithm from the drop-down list.

**[Key Algorithm]**

Select the key generation algorithm from [RSA] or [ECDSA], then select the key length from the drop-down list. In any case, the larger the number for the key length, the slower the communication. However, the security is tighter.

**NOTE:**

- When [SHA384] or [SHA512] is selected in [Signature Algorithm], [512-bit] cannot be selected as the key length when [RSA] is selected in [Key Algorithm].

**b [Certificate Signing Request (CSR) Settings]**

**[Country/Region]**

Click the [Select Country/Region] radio button and select the country/region from the drop-down list. You can also click the [Enter Internet Country Code] radio button and enter a country code, such as "US" for the United States.

**[State]/[City]**

Enter alphanumeric characters for the location as necessary.

**[Organization]/[Organization Unit]**

Enter alphanumeric characters for the organization name as necessary.

**[Common Name]**

Enter alphanumeric characters for the common name of the certificate as necessary. "Common Name" is often abbreviated as "CN."

**7 Click [OK].**

- Generating a key and CSR may take some time.

**8 Click [Store in File].**

- A dialog box for storing the file appears. Choose where to store the file and click [Save].  
 ⇒ The CSR file is stored on the computer.

**9 Attach the stored file and submit the application to the certification authority.**

**Registering a Certificate to a Key**

The key with the CSR generated cannot be used until the certificate issued from the certificate authority based on the CSR is registered in the key. Once the certification authority has issued the certificate, register it using the procedure below.

- 1 Start the Remote UI and log in to System Manager Mode. ▶Starting Remote UI(P. 415)**
- 2 Click [Settings/Registration] on the Portal page. ▶Remote UI Screen(P. 416)**
- 3 Select [Device Management] ▶ [Key and Certificate Settings].**
- 4 Click [Key Name] or [Certificate] required to register the certificate.**

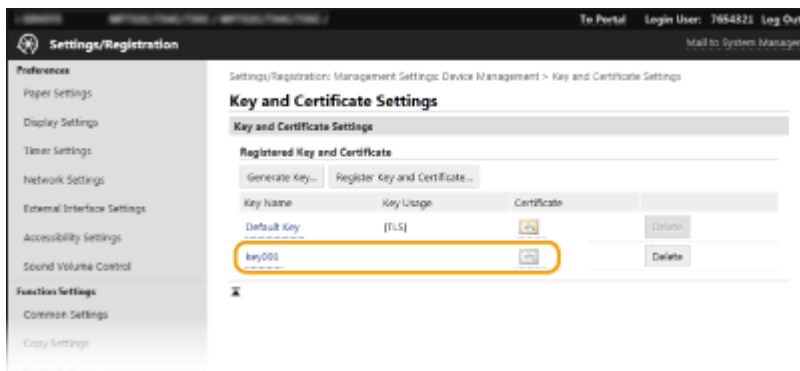

- 5 Click [Register Certificate].**
- 6 Click [Browse], specify the file for the certificate signing request, and click [Register].**

**LINKS**

- ▶Configuring the Key and Certificate for TLS(P. 376)
- ▶Generating the Key and Certificate for Network Communication(P. 379)
- ▶Registering the Key and Certificate for Network Communication(P. 385)
- ▶Configuring IPsec Settings(P. 387)



# Registering the Key and Certificate for Network Communication

261J-07A

You can obtain the key and certificate, and the CA certificate from a certification authority (CA) for use with the machine. Install and register the obtained key and certificate file and CA certificate file in this machine using Remote UI. Check the key and certificate, and CA certificate conditions that are required for the machine in advance ( [▶ Management Functions\(P. 682\)](#) ).



## NOTE

- For more information about the basic operations to be performed when setting the machine from the Remote UI, see [▶Setting Up Menu Options from Remote UI\(P. 424\)](#) .

**1 Start the Remote UI and log in to System Manager Mode.** [▶Starting Remote UI\(P. 415\)](#)

**2 Click [Settings/Registration] on the Portal page.** [▶Remote UI Screen\(P. 416\)](#)

**3 Select [Device Management] ▶ [Key and Certificate Settings] or [CA Certificate Settings].**

- Click [Key and Certificate Settings] to install a key and certificate, or [CA Certificate Settings] to install a CA certificate.

**4 Click [Register Key and Certificate] or [Register CA Certificate].**

## NOTE:

### Deleting a registered key and certificate or CA certificate

- Click [Delete] on the right of the key and certificate or CA certificate you want to delete ▶ click [OK]. You cannot delete the preinstalled CA certificates.
- A key and certificate cannot be deleted if it is currently used for some purpose, such as when "[TLS]" or "[IEEE 802.1X]" is displayed under [Key Usage]. In this case, disable the function or replace the key and certificate before deleting it.

### Disabling or enabling the preinstalled CA certificates

- Click [Disable] on the right of the preinstalled CA certificate you want to disable. To enable the certificate again, click [Enable] on the right of the certificate.

**5 Click [Install].**

**NOTE:**

**Deleting the key and certificate file or CA certificate file**

- Click [Delete] on the right of the file you want to delete ► click [OK].

**6 Click [Browse], specify the file to install, and click [Start Installation].**

► The key and certificate file or the CA certificate file is installed on the machine from a computer.

**7 Register the key and certificate or CA certificate.**

**■ Registering a key and certificate**

- 1 Click [Register] on the right of the key and certificate file you want to register.
- 2 Enter the name of the key and password.

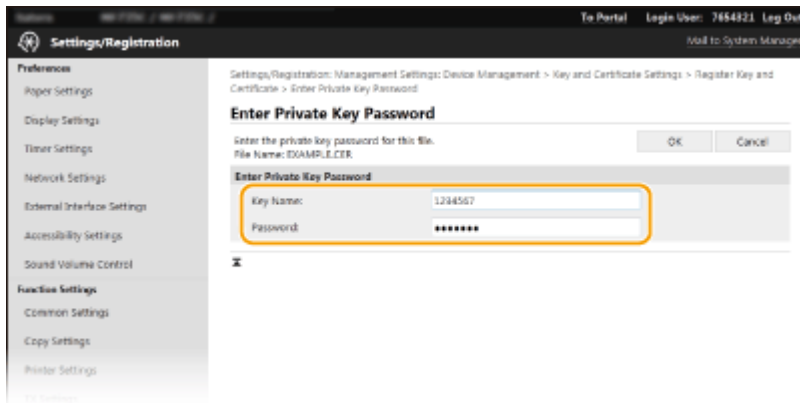

**[Key Name]**

Enter alphanumeric characters for the name of the key to be registered.

**[Password]**

Enter alphanumeric characters for the password of the private key set for the file to be registered.

- 3 Click [OK].

**■ Registering a CA certificate**

Click [Register] on the right of the CA certificate file you want to register.

**LINKS**

- ▶ **Generating the Key and Certificate for Network Communication(P. 379)**
- ▶ **Configuring the Key and Certificate for TLS(P. 376)**
- ▶ **Configuring IPSec Settings(P. 387)**
- ▶ **Configuring IEEE 802.1X Authentication Settings(P. 394)**

## Configuring IPsec Settings

261J-07C

Internet Protocol Security (IPsec or IPsec) is a protocol suite for encrypting data transported over a network, including Internet networks. While TLS only encrypts data used on a specific application, such as a Web browser or an e-mail application, IPsec encrypts either whole IP packets or the payloads of IP packets, offering a more versatile security system. The IPsec of the machine works in transport mode, in which the payloads of IP packets are encrypted. With this feature, the machine can connect directly to a computer that is in the same virtual private network (VPN). Check the system requirements ( [▶Management Functions\(P. 682\)](#) ) and set the necessary configuration on the computer before you configure the machine.



### NOTE

#### Using IPsec with IP address filter

- IP address filter settings are applied before the IPsec policies. [▶Specifying IP Addresses for Firewall Settings\(P. 366\)](#)

## Configuring IPsec Settings

Before using IPsec for encrypted communication, you need to register security policies (SP). A security policy consists of the groups of settings described below. After registering policies, specify the order in which they are applied.

### Selector

Selector defines conditions for IP packets to apply IPsec communication. Selectable conditions include IP addresses and port numbers of the machine and the devices to communicate with.

### IKE

IKE configures the IKEv1 that is used for key exchange protocol. Note that instructions vary depending on the authentication method selected.

#### [Pre-Shared Key Method]

This authentication method uses a common key word, called Shared Key, for communication between the machine and other devices. Enable TLS for the Remote UI before specifying this authentication method ( [▶Configuring the Key and Certificate for TLS\(P. 376\)](#) ).

#### [Digital Signature Method]

The machine and the other devices authenticate each other by mutually verifying their digital signatures. Generate or install the key and certificate beforehand ( [▶Registering the Key and Certificate for Network Communication\(P. 385\)](#) ).

### AH/ESP

Specify the settings for AH/ESP, which is added to packets during IPsec communication. AH and ESP can be used at the same time. You can also select whether or not to enable PFS for tighter security.

### NOTE

- For more information about the basic operations to be performed when setting the machine from the Remote UI, see [▶Setting Up Menu Options from Remote UI\(P. 424\)](#) .

**1 Start the Remote UI and log in to System Manager Mode. ▶Starting Remote UI(P. 415)**

**2 Click [Settings/Registration] on the Portal page. ▶Remote UI Screen(P. 416)**

**3 Select [Network Settings] ▶ [IPSec Settings].**

**4 Click [Edit].**

**5 Select the [Use IPSec] check box and click [OK].**

- If you want the machine to only receive packets that match one of the security policies that you define in the steps below, clear the [Receive Non-Policy Packets] check box.

**6 Click [Register New Policy].**

**7 Specify the Policy Settings.**

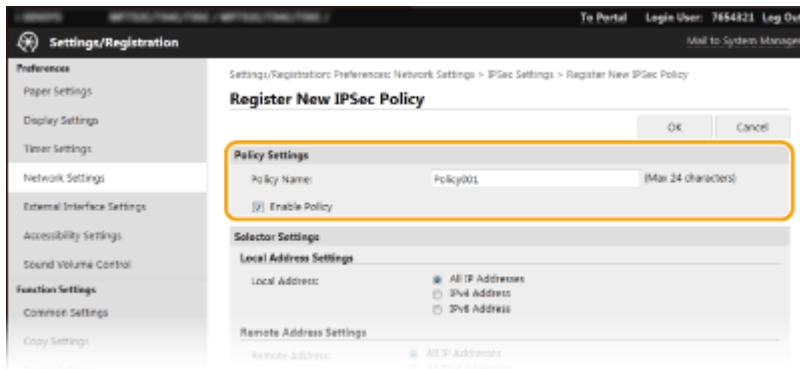

**1** In the [Policy Name] text box, enter alphanumeric characters for a name that is used for identifying the policy.

**2** Select the [Enable Policy] check box.

**8 Specify the Selector Settings.**

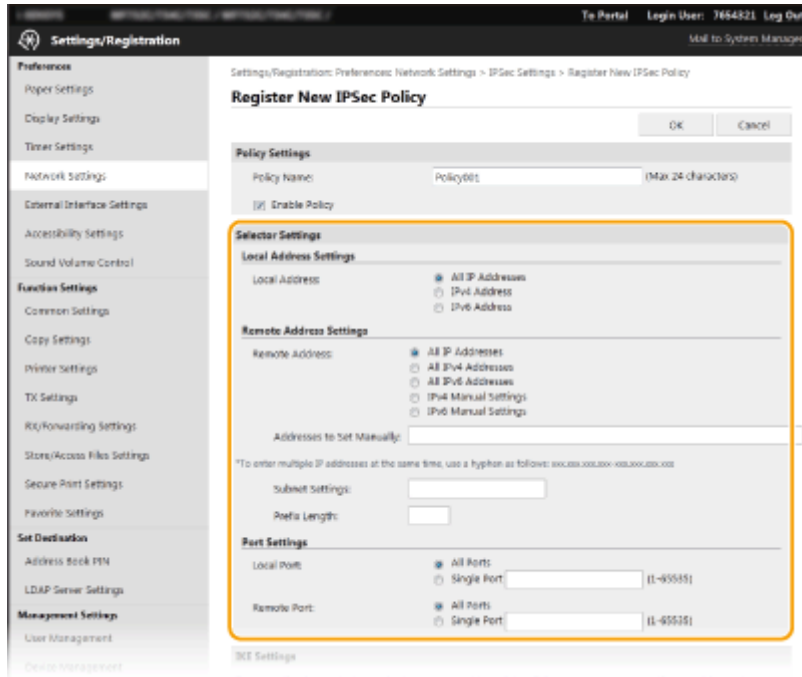

**[Local Address]**

Click the radio button for the type of IP address of the machine to apply the policy.

[All IP Addresses]	Select to use IPSec for all IP packets.
[IPv4 Address]	Select to use IPSec for all IP packets that are sent to or from the IPv4 address of the machine.
[IPv6 Address]	Select to use IPSec for all IP packets that are sent to or from an IPv6 address of the machine.

**[Remote Address]**

Click the radio button for the type of IP address of the other devices to apply the policy.

[All IP Addresses]	Select to use IPSec for all IP packets.
[All IPv4 Addresses]	Select to use IPSec for all IP packets that are sent to or from IPv4 addresses of the other devices.
[All IPv6 Addresses]	Select to use IPSec for all IP packets that are sent to or from IPv6 addresses of the other devices.
[IPv4 Manual Settings]	Select to specify a single IPv4 address or a range of IPv4 addresses to apply IPSec. Enter the IPv4 address (or the range) in the [Addresses to Set Manually] text box.
[IPv6 Manual Settings]	Select to specify a single IPv6 address or a range of IPv6 addresses to apply IPSec. Enter the IPv6 address (or the range) in the [Addresses to Set Manually] text box.

**[Addresses to Set Manually]**

If [IPv4 Manual Settings] or [IPv6 Manual Settings] is selected for [Remote Address], enter the IP address to apply the policy. You can also enter a range of addresses by inserting a hyphen between the addresses.

**NOTE:**

**Entering IP addresses**

	Description	Example
Entering a single address	<b>IPv4:</b> Delimit numbers with periods.	192.168.0.10

	Description	Example
	<b>IPv6:</b> Delimit alphanumeric characters with colons.	fe80::10
Specifying a range of addresses	Insert a hyphen between the addresses.	192.168.0.10-192.168.0.20

**[Subnet Settings]**

When manually specifying IPv4 address, you can express the range by using the subnet mask. Enter the subnet mask using periods to delimit numbers (example:"255.255.255.240").

**[Prefix Length]**

Specifying the range of IPv6 addresses manually also allows you to specify the range using prefixes. Enter a range between 0 and 128 as the prefix length.

**[Local Port]/[Remote Port]**

If you want to create separate policies for each protocol, such as HTTP or WSD, click the [Single Port] radio button and enter the appropriate port number for the protocol to determine whether to use IPSec.

**IMPORTANT:**

**IPSec is not applied to the following packets**

- Loopback, multicast, and broadcast packets
- IKE packets (using UDP on port 500)
- ICMPv6 neighbor solicitation and neighbor advertisement packets

**9 Specify the IKE Settings.**

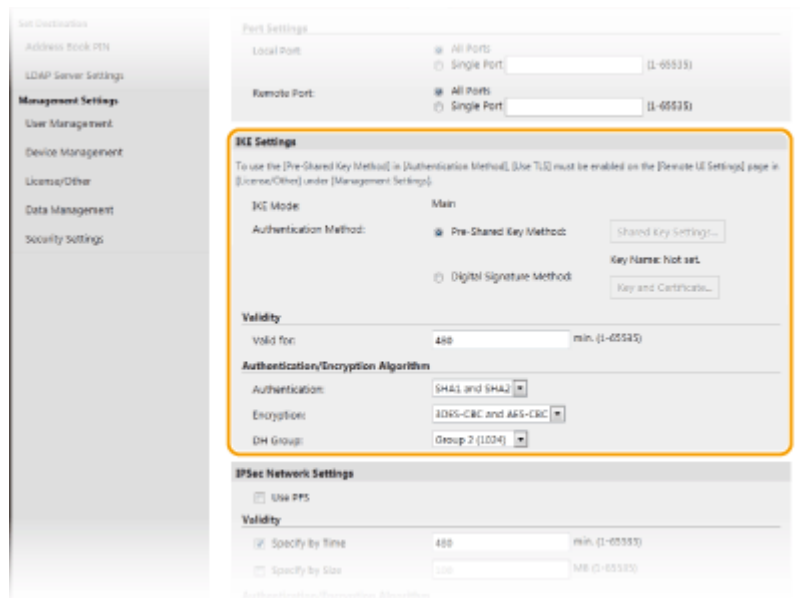

**[IKE Mode]**

The mode used for the key exchange protocol is displayed. The machine supports the main mode, not the aggressive mode.

**[Authentication Method]**

Select [Pre-Shared Key Method] or [Digital Signature Method] for the method used when authenticating the machine. You need to enable TLS for the Remote UI before selecting [Pre-Shared Key Method]. You need to generate or install the key and certificate before selecting [Digital Signature Method]. **Configuring the Key and Certificate for TLS(P. 376)**

**[Valid for]**

Specify how long a session lasts for IKE SA (ISAKMP SA). Enter the time in minutes.

**[Authentication]/[Encryption]/[DH Group]**

Select an algorithm from the drop-down list. Each algorithm is used in the key exchange.

[Authentication]	Select the hash algorithm.
[Encryption]	Select the encryption algorithm.
[DH Group]	Select the Diffie-Hellman group, which determines the key strength.

**■ Authenticating a machine using a pre-shared key**

- 1 Click the [Pre-Shared Key Method] radio button for [Authentication Method] and then click [Shared Key Settings].
- 2 Enter alphanumeric characters for the pre-shared key and click [OK].
- 3 Specify the [Valid for] and [Authentication]/[Encryption]/[DH Group] settings.

**■ Authenticating a machine using digital signature method**

- 1 Click the [Digital Signature Method] radio button for [Authentication Method] and then click [Key and Certificate].
- 2 Click [Register Default Key] on the right of the key and certificate you want to use.

**NOTE:**

**Viewing details of a certificate**

- You can check the details of the certificate or verify the certificate by clicking the corresponding text link under [Key Name], or the certificate icon.
- 3 Specify the [Valid for] and [Authentication]/[Encryption]/[DH Group] settings.

**10 Specify the IPSec Network Settings.**

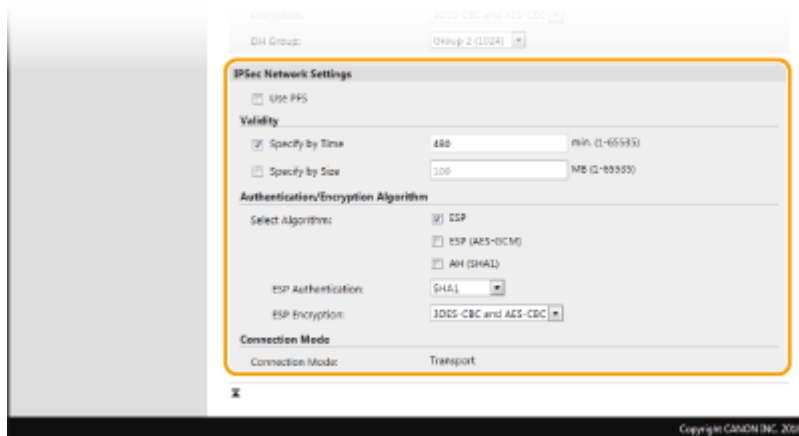

**[Use PFS]**

Select the check box to enable Perfect Forward Secrecy (PFS) for IPSec session keys. Enabling PFS enhances the security while increasing the load on the communication. Make sure that PFS is also enabled for the other devices.

**[Specify by Time]/[Specify by Size]**

Set the conditions for terminating a session for IPSec SA. IPSec SA is used as a communication tunnel. Select either or both of the check boxes as necessary. If both check boxes are selected, the IPSec SA session is terminated when either of the conditions has been satisfied.

[Specify by Time]	Enter a time in minutes to specify how long a session lasts.
[Specify by Size]	Enter a size in megabytes to specify how much data can be transported in a session.

**[Select Algorithm]**

Select the [ESP], [ESP (AES-GCM)], or [AH (SHA1)] check box(es) depending on the IPSec header and the algorithm used. AES-GCM is an algorithm for both authentication and encryption. If [ESP] is selected, also select algorithms for authentication and encryption from the [ESP Authentication] and [ESP Encryption] drop-down lists.

[ESP Authentication]	To enable the ESP authentication, select [SHA1] for the hash algorithm. Select [Do Not Use] if you want to disable the ESP authentication.
[ESP Encryption]	Select the encryption algorithm for ESP. You can select [NULL] if you do not want to specify the algorithm, or select [Do Not Use] if you want to disable the ESP encryption.

**[Connection Mode]**

The connection mode of IPSec is displayed. The machine supports transport mode, in which the payloads of IP packets are encrypted. Tunnel mode, in which whole IP packets (headers and payloads) are encapsulated is not available.

**11 Click [OK].**

- If you need to register an additional security policy, return to step 6.

**12 Arrange the order of policies listed under [Registered IPSec Policies].**

- Policies are applied from one at the highest position to the lowest. Click [Up] or [Down] to move a policy up or down the order.

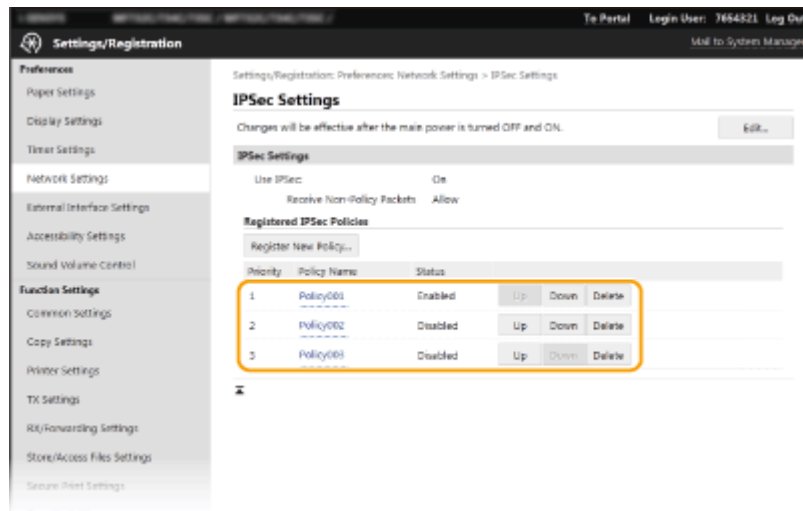

**NOTE:**

**Editing a policy**

- Click the corresponding text link under [Policy Name] for the edit screen.

**Deleting a policy**

- Click [Delete] on the right of the policy name you want to delete ► click [OK].

**13 Restart the machine.**

- Turn OFF the machine, wait for at least 10 seconds, and turn it back ON.

**NOTE**





### Using the operation panel

- You can also enable or disable IPSec communication from <Menu> in the Home screen.  **<Use IPSec>(P. 465)**

### LINKS

---

-  **Configuring the Key and Certificate for TLS(P. 376)**
-  **IPSec Policy List(P. 584)**

## Configuring IEEE 802.1X Authentication Settings

261J-07E

The machine can connect to an 802.1X network as a client device. A typical 802.1X network consists of a RADIUS server (authentication server), LAN switch (authenticator), and client devices with authentication software (supplicants). If a device tries to connect to the 802.1X network, the device must go through user authentication in order to prove that the connection is made by an authorized user. Authentication information is sent to and checked by a RADIUS server, which permits or rejects communication to the network depending on the authentication result. If authentication fails, a LAN switch (or an access point) blocks access from the outside of the network.

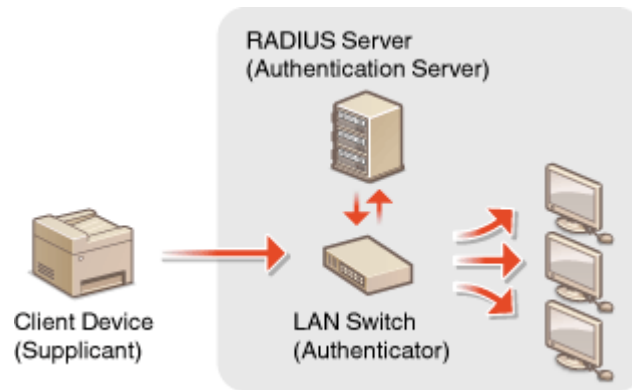

### IEEE 802.1X Authentication Method

Select the authentication method from the options below. If necessary, install or register a key and certificate or a CA certificate before configuring IEEE 802.1X authentication ( [▶Registering the Key and Certificate for Network Communication\(P. 385\)](#) ).

#### ■ TLS

The machine and the authentication server authenticate each other by mutually verifying their certificates. A key and certificate issued by a certification authority (CA) is required for the client authentication (when authenticating the machine). For the server authentication, a CA certificate installed via the Remote UI can be used in addition to a CA certificate preinstalled in the machine.

#### ■ TTLS

This authentication method uses a user name and password for the client authentication and a CA certificate for the server authentication. MSCHAPv2 or PAP can be selected as the internal protocol. TTLS can be used with PEAP at the same time. Enable TLS for the Remote UI before configuring this authentication method ( [▶Configuring the Key and Certificate for TLS\(P. 376\)](#) ).

#### ■ PEAP

The required settings are almost the same as those of TTLS. MSCHAPv2 is used as the internal protocol. Enable TLS for the Remote UI before configuring this authentication method ( [▶Configuring the Key and Certificate for TLS\(P. 376\)](#) ).

## NOTE

- For more information about the basic operations to be performed when setting the machine from the Remote UI, see [▶Setting Up Menu Options from Remote UI\(P. 424\)](#) .

- 1 Start the Remote UI and log in to System Manager Mode. [▶Starting Remote UI\(P. 415\)](#)

**2** Click [Settings/Registration] on the Portal page. ▶ Remote UI Screen(P. 416)

**3** Select [Network Settings] ▶ [IEEE 802.1X Settings].

**4** Click [Edit].

**5** Select the [Use IEEE 802.1X] check box, and enter the login name in the [Login Name] text box.

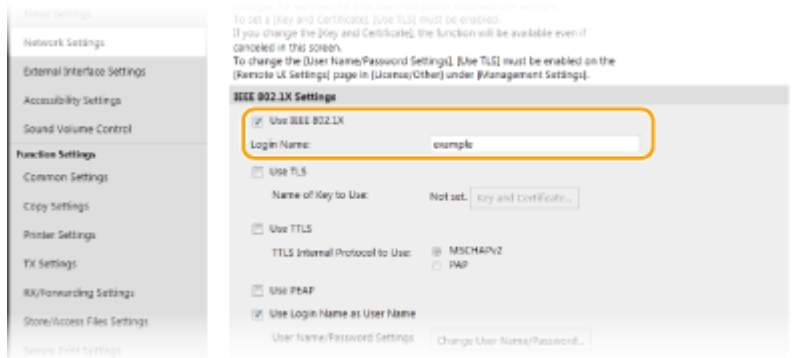

**[Use IEEE 802.1X]**

Select the check box to enable IEEE 802.1X authentication.

**[Login Name]**

Enter alphanumeric characters for a name (EAP identity) that is used for identifying the user.

**6** Configure the required settings according to the specified authentication method.



**■ Setting TLS**

**1** Select the [Use TLS] check box and click [Key and Certificate].

- You cannot use TLS with TTLS or PEAP.

**2** Click [Register Default Key] on the right of the key and certificate you want to use for the client authentication.

**NOTE:**

**Viewing details of a certificate**

- You can check the details of the certificate or verify the certificate by clicking the corresponding text link under [Key Name], or the certificate icon.

## ■ Setting TTLS/PEAP

- 1 Select the [Use TTLS] or [Use PEAP] check box.

### NOTE:

#### Internal protocol for TTLS

- You can select MSCHAPv2 or PAP.

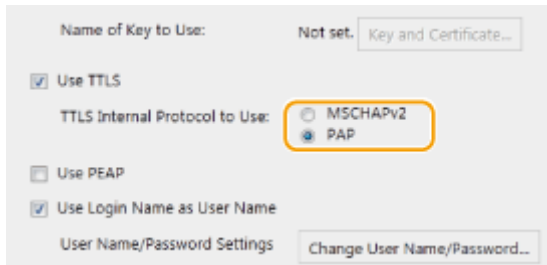

- 2 Click [Change User Name/Password].

- To specify a user name other than the login name, clear the [Use Login Name as User Name] check box. Select the check box if you want to use the login name as the user name.

- 3 Set the user name/password.

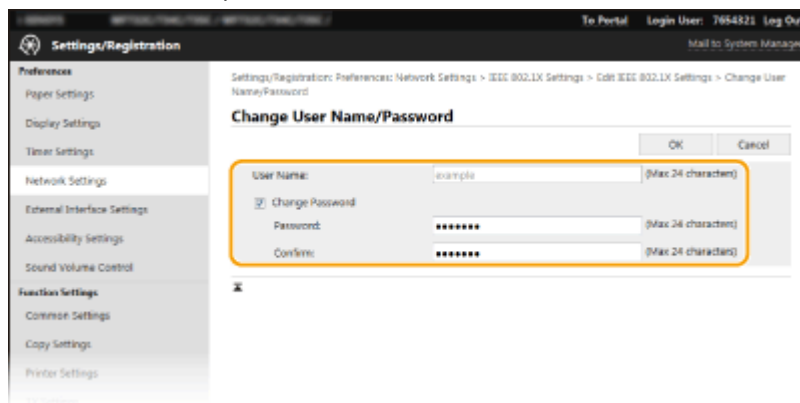

#### [User Name]

Enter alphanumeric characters for the user name.

#### [Change Password]

To set or change the password, select the check box and enter alphanumeric characters for the new password both in the [Password] and [Confirm] text boxes.

- 4 Click [OK].

- 7 Click [OK].

- 8 Restart the machine.

- Turn OFF the machine, wait for at least 10 seconds, and turn it back ON.

## NOTE

### Using the operation panel

- You can also enable or disable IEEE 802.1X authentication from <Menu> in the Home screen.  **<Use IEEE 802.1X>(P. 468)**

### LINKS

---

-  **Configuring the Key and Certificate for TLS(P. 376)**

## Restricting the Machine's Functions

261J-07F

Some of the functions of the machine may rarely be used or provide opportunities for misuse. For security purposes, the machine can be set to limit its capabilities by partially or completely disabling these functions.

### Restricting Access to Address Book and Sending Functions

You can specify the PIN in the Address Book to disable a general user from modifying data or limit destinations that can be specified for fax sending. You can also disable a user from collectively sending a fax to multiple destinations (Sequential Broadcast). **Restricting Access to Address Book and Sending Functions(P. 400)**



### Restricting Printing from a Computer

You can limit "printing from computer" only to secure documents so that no print jobs can be executed unless the PIN is entered on the machine side. **Restricting Printing from a Computer(P. 407)**



### Restricting USB Functions

The USB connection allows an easy connection with peripheral devices, but it may cause a security risk such as an information leakage. You can restrict a USB connection with a computer or saving to a USB memory device.

**Restricting USB Functions(P. 408)**

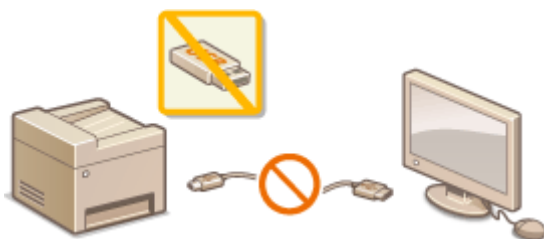

### Disabling HTTP Communication

When not performing operations via the network, for example, when using the machine via USB connection, you can disable HTTP communication to prevent a hacking via the HTTP port. **Disabling HTTP Communication(P. 410)**



## Disabling Remote Management

---

When not using Remote UI, you can disable functions to prevent an unauthorized remote operation via Remote UI. ▶ **Disabling Remote UI(P. 411)**



# Restricting Access to Address Book and Sending Functions

261J-07H

Some cases of information leakage can be prevented by limiting the available fax and e-mail destinations to those registered in the Address Book or LDAP servers, or by setting a PIN for the Address Book so that unauthorized users cannot add or edit Address Book entries. You can also avoid sending documents to unintended recipients if the machine is set to ask you to enter the fax number twice for confirmation.



- ▶ **Restricting Use of the Address Book(P. 401)**
- ▶ **Limiting Available Destinations(P. 403)**
- ▶ **Restricting the Fax Sending Functions(P. 405)**



# Restricting Use of the Address Book

261J-07J



The Address Book can be set to require users to enter a PIN in order to add new entries to the Address Book or edit existing entries. Setting a PIN to the Address Book can reduce the risk of documents being sent to unintended recipients because changes to the Address Book can only be made by users who know the PIN.

**1** Select <Menu> in the Home screen. [▶Home Screen\(P. 121\)](#)

**2** Select <Set Destination>.

- If the login screen appears, enter the correct ID and PIN. [▶Logging in to the Machine\(P. 132\)](#)

**3** Select <Address Book PIN>.

**4** Specify the PIN.

- Enter the number, and select <Apply>.
- The Confirm screen is displayed. Enter the PIN once again to confirm.



## NOTE:

- You cannot set a PIN that consists only of zeros, such as "00" or "0000000".
- To cancel the PIN setting, clear the information you entered in **C** and select <Apply> with the field blank.

## NOTE

In addition to setting the Address Book PIN, you can further enhance security by performing the following operations:

- Restricting the addition of new destinations, see [▶Restricting New Destinations that Can Be Specified\(P. 403\)](#) .
- Disabling the PC fax function, see [▶Restricting Fax Sending from a Computer\(P. 405\)](#) .

## LINKS

- [▶Registering Destinations\(P. 176\)](#)
- [▶Registering Destinations from Remote UI\(P. 427\)](#)

- ▶ **Configuring Basic E-Mail Settings(P. 87)**
- ▶ **Setting a Shared Folder as a Save Location(P. 95)**

## Limiting Available Destinations

261J-07K



By limiting destinations that can be specified to those registered in the Address Book or LDAP servers, you can reduce the possibility of specifying unintended destinations and prevent users from leaking information. You can configure the setting to display the confirmation screen to prevent the user from misdialing when specifying a coded dial number in the Address Book.

- ▶ **Restricting New Destinations that Can Be Specified(P. 403)**
- ▶ **Disabling Use of Previously Used Destinations(P. 403)**
- ▶ **Displaying Destinations in Address Book(P. 403)**
- ▶ **Checking Destinations when Sending Data(P. 404)**

### Restricting New Destinations that Can Be Specified

Restrict destinations that can be specified when sending faxes or scanned documents to "those already registered in the Address Book," "those previously used," or "those searchable from the LDAP servers." When this function is enabled, the machine prohibits users from entering destinations using the numeric keys, adding new entries to the Address Book, and editing the existing Address Book entries.



<Menu> ▶ <Function Settings> ▶ <Send> ▶ <Common Settings> ▶ <Restrict New Destinations> ▶ <On> ▶

### IMPORTANT

- This function does not limit the available destinations for PC faxing. ▶ **Restricting Fax Sending from a Computer(P. 405)**

### Disabling Use of Previously Used Destinations

Prohibits the specification of destinations from the transmission records. Using this restriction prevents destinations being selected from the transmission records for "Send Fax," "Scan and Send as E-mail" and "Scan and Save to Shared Folder or FTP Server."





<Menu> ▶ <Function Settings> ▶ <Send> ▶ <Common Settings> ▶ <Restrict Resending from Log> ▶ <On> ▶

### Displaying Destinations in Address Book

When using coded dial numbers to specify destinations, you need to precisely remember whose destination (or what group) is registered in what coded dial number. If you do not remember all these numbers accurately, you may send your documents to unintended destinations. You can avoid sending data to unintended recipients by configuring the

machine to display the details of the coded dial number you selected/entered as a sending destination on the screen before you send documents to that destination.



<Menu> ▶ <Function Settings> ▶ <Send> ▶ <Common Settings> ▶ <Confirm When Coded Dial TX> ▶ <On> ▶ 

## Checking Destinations when Sending Data

You can configure a setting so that the destination confirmation screen is displayed when fax, e-mail, or I-Fax sending starts. If <Only for Sequential Broadcast> is selected, the confirmation screen is displayed only when multiple destinations are specified.



<Menu> ▶ <Function Settings> ▶ <Send> ▶ <Common Settings> ▶ <Confirm Dest. Before Sending> ▶ Select <On> or <Only for Sequential Broadcast> ▶ 

### LINKS

---

- ▶ **Sending I-Faxes(P. 244)**
- ▶ **Sending Data by E-Mail/Saving Data to a Shared Folder or FTP Server(P. 286)**
- ▶ **Recalling Previously Used Settings for Sending/Saving (Recall Settings)(P. 308)**
- ▶ **Restricting Use of the Address Book(P. 401)**
- ▶ **Restricting the Fax Sending Functions(P. 405)**

## Restricting the Fax Sending Functions

261J-07L

You can set various restrictions for sending faxes, which can prevent information leakage to third parties or sending documents to unintended destinations.



- ▶ **Confirming the Entered Fax Number(P. 405)**
- ▶ **Restricting Fax Sending from a Computer(P. 405)**
- ▶ **Restricting Sequential Broadcasts(P. 405)**

### Confirming the Entered Fax Number

You can configure the setting to display the confirmation screen to prevent the user from misdialing when entering a destination fax number using the numeric keys.



### Restricting Fax Sending from a Computer

You can prohibit users from PC faxing (faxing from a computer).



### Restricting Sequential Broadcasts

You can prohibit a function that collectively sends a fax to multiple destinations (Sequential Broadcast).



#### LINKS

- ▶ **Basic Operations for Sending Faxes(P. 214)**
- ▶ **Recalling Previously Used Settings for Sending (Recall Settings)(P. 227)**

- ▶ **Sending Faxes from Your Computer (PC Fax)(P. 240)**
- ▶ **Enabling the Department ID Management for Jobs from a Computer(P. 354)**
- ▶ **Restricting Use of the Address Book(P. 401)**
- ▶ **Limiting Available Destinations(P. 403)**

## Restricting Printing from a Computer

261J-07R

You can drastically reduce information leakage risks by limiting the documents printable from a computer to the Secure Print documents ( ▶ **Printing a Document Secured by a PIN (Secure Print)(P. 261)** ).



<Menu> ▶ <Function Settings> ▶ <Secure Print> ▶ <Restrict Printer Jobs> ▶ <On> ▶  
<Apply> ▶ <OK> ▶ Restart the machine

## Restricting USB Functions

261J-07S

USB is a convenient way of connecting peripheral devices and storing or relocating data, but USB can also be a source of information leakage if it is not properly managed. Be especially careful when handling USB memory devices. This section describes how to restrict connection via the USB port of the machine and how to prohibit use of USB memory devices.

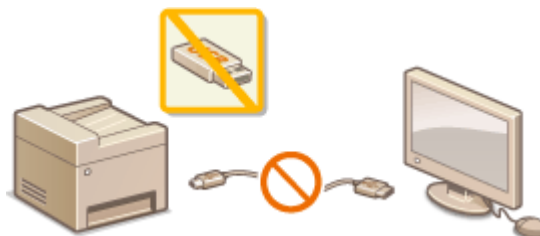

- ▶ **Restricting the USB Connection with a Computer(P. 408)**
- ▶ **Restricting the Scan to USB Function(P. 408)**
- ▶ **Restricting the USB Print Function(P. 408)**

### Restricting the USB Connection with a Computer

You can disable the computer connection USB port located on the back side of the machine. If this port is disabled, the machine cannot communicate with a computer via USB. This setting does not affect the front USB port, which is for attaching USB memory devices.



<Menu> ▶ <Preferences> ▶ <External Interface> ▶ <USB Settings> ▶ Select <Off> in <Use as USB Device> ▶ <Apply> ▶ <OK> ▶ Restart the machine

### Restricting the Scan to USB Function

You can disable storing scanned original data into a USB memory device.



<Menu> ▶ <Function Settings> ▶ <Store/Access Files> ▶ <Memory Media Settings> ▶ Select <Off> in <Use Scan Function> ▶ <Apply> ▶ <OK> ▶ Restart the machine

### Restricting the USB Print Function

You can disable printing data from a USB memory device. The data in the USB memory device cannot be printed.



<Menu> ▶ <Function Settings> ▶ <Store/Access Files> ▶ <Memory Media Settings> ▶ Select <Off> in <Use Print Function> ▶ <Apply> ▶ <OK> ▶ Restart the machine



- ▶ **Basic Operations for Scanning Originals(P. 279)**
- ▶ **Printing from a USB Memory Device (Memory Media Print)(P. 265)**

## Disabling HTTP Communication

261J-07U

HTTP is used for communications over the network, such as when you access the machine via the Remote UI. If you are using a USB connection or are otherwise not using HTTP, you can disable HTTP to block malicious third-party intrusions via the unused HTTP port.



### IMPORTANT

- Disabling HTTP disables some of the network capabilities, such as the Remote UI, WSD printing, and printing with Google Cloud Print.



<Menu> ▶ <Preferences> ▶ <Network> ▶ <TCP/IP Settings> ▶ <Use HTTP> ▶ <Off> ▶ <Yes> ▶ 

### LINKS

- ▶ [Managing the Machine from a Computer \(Remote UI\)\(P. 414\)](#)
- ▶ [Changing Port Numbers\(P. 372\)](#)
- ▶ [Configuring Printing Protocols and WSD Functions\(P. 41\)](#)
- ▶ [Using Google Cloud Print\(P. 341\)](#)

## Disabling Remote UI

---

261J-07W

The Remote UI is useful because the machine settings can be specified by using a Web browser on a computer. To use the Remote UI, the machine must be connected to a computer over the network. If the machine is connected to a computer via USB, or if you do not need to use the Remote UI, you might want to disable the Remote UI to reduce the risk of having your machine controlled remotely over the network by malicious third parties.



<Menu> ▶ <Management Settings> ▶ <License/Other> ▶ <Remote UI Settings> ▶ Select <Off> in <Use Remote UI> ▶ <Apply> ▶ <OK> ▶ Restart the machine

### LINKS

---

- ▶ [Managing the Machine from a Computer \(Remote UI\)\(P. 414\)](#)
- ▶ [Disabling HTTP Communication\(P. 410\)](#)

# Increasing the Security of Documents

---

261J-07X

The machine is equipped with security functions designed to prevent documents from being leaked or tampered with.

## Device Signature

---

The digital signature is added to scanned documents using a key and certificate mechanism in order to prove to the recipient that the document has been created on the machine. The recipient can verify "the device that created the document" and "whether the document has been tampered with." Before adding a device signature, you need to generate a key and certificate (device certificate) that is used for the device signature using the machine. ➤ **Generating a Device Signature Key(P. 413)**

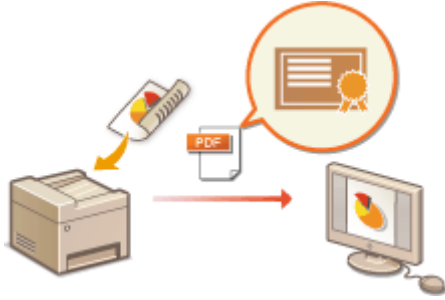

# Generating a Device Signature Key

261J-07Y

You can generate a key and certificate for the device signature that show a document was scanned on the machine. The certificate is appended when an document is scanned and converted into a PDF file.

## IMPORTANT

- Only one key and certificate for the device signature can be generated. It cannot be deleted.
- An optional Send PDF Security Feature Set is required. [▶System Options\(P. 690\)](#)

## NOTE

- Key and certificate for the device signature are valid for five years. Renew them when required.
- For more information about the basic operations to be performed when setting the machine from the Remote UI, see [▶Setting Up Menu Options from Remote UI\(P. 424\)](#) .

- 1 Start the Remote UI and log in to System Manager Mode.** [▶Starting Remote UI\(P. 415\)](#)
- 2 Click [Settings/Registration] on the Portal page.** [▶Remote UI Screen\(P. 416\)](#)
- 3 Select [Device Management] ▶ [Key and Certificate Settings].**
- 4 Click [Generate Key].**
- 5 Select the [Device Signature] check box, and click [OK].**

⇒ A key and certificate for the device signature is generated.

### ■Renewing the Device Signature Key and the Key and Certificate

- 1** Click [Update] at the right of the key and certificate for the device signature.
- 2** Click [OK].

## Managing the Machine from a Computer (Remote UI)

---

261J-080

Using a Web browser to operate the machine remotely, you can check the documents waiting to be printed or the status of the machine. You can also make various settings. You can do this without leaving your desk, making system management easier. For more information about the system requirements for the Remote UI, see **System Environment(P. 684)** .



### Functions of the Remote UI

- ▶ **Checking the Status and Logs(P. 418)**
- ▶ **Setting Up Menu Options from Remote UI(P. 424)**
- ▶ **Registering Destinations from Remote UI(P. 427)**
- ▶ **Security Policy(P. 431)**
- ▶ **Importing/Exporting the Setting Data(P. 437)**

### Basics of the Remote UI

- ▶ **Starting Remote UI(P. 415)**

# Starting Remote UI

261J-081

To operate remotely, you need to input the IP address of the machine into a Web browser and start the Remote UI. Check the IP address set to the machine in advance ( ▶ **Viewing Network Settings(P. 38)** ). If you have any questions, ask your Network Administrator.

## 1 Start the Web browser.

## 2 Enter "http://<the IP address of the machine>/" in the address field, and press the [ENTER] key.

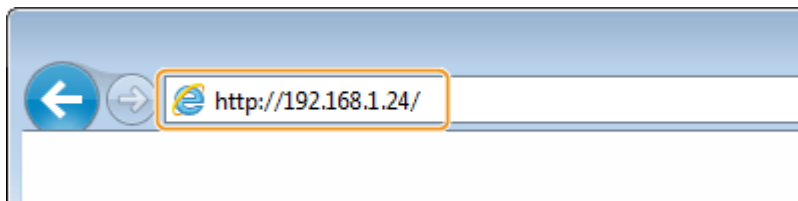

- If you want to use an IPv6 address, enclose the IPv6 address with brackets (example: http://[fe80::2e9e:fcff:fe4e:dbce]/).

### NOTE:

#### If a security alert is displayed

- A security alert may be displayed when the Remote UI communication is encrypted ( ▶ **Configuring the Key and Certificate for TLS(P. 376)** ). When certificate settings or TLS settings have no errors, continue browsing the Web site.

## 3 Log in to the Remote UI.

### ■ When the Department ID Management is disabled

Select [System Manager Mode] or [General User Mode], and enter a value in [Remote UI Access PIN] as necessary.

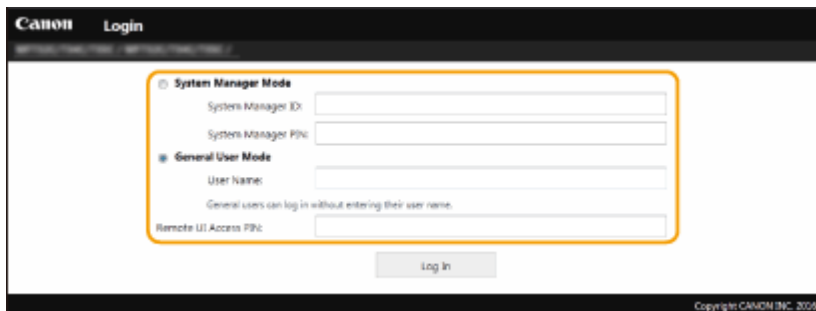

#### [System Manager Mode]

You can perform all the Remote UI operations and settings. Enter the appropriate ID in [System Manager ID] and PIN in [System Manager PIN]. ▶ **Setting the System Manager ID and PIN(P. 349)**

#### [General User Mode]

You can check the status of documents or the machine, and you can also change some of the settings. When you want to check if a specific document of yours is in the print queue or cancel the printing of a document of yours in the print queue, enter the user name of the document in [User Name]. The user name is automatically set to print documents based on information such as your computer name or computer login name.

#### [Remote UI Access PIN]

If [Remote UI Access PIN] is set, enter the PIN. **▶Setting a Remote UI PIN(P. 357)**

**■When the Department ID Management is enabled**

Enter the appropriate ID in [Department ID] and PIN in [PIN]. **▶Setting the Department ID Management(P. 351)**

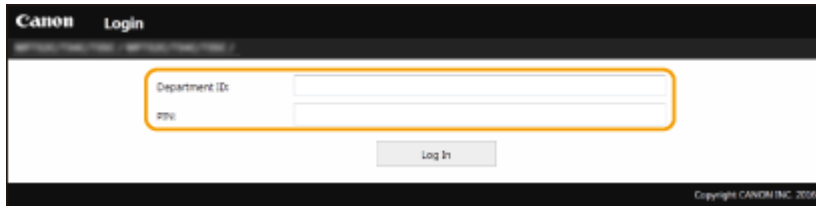

**4 Click [Log In].**

▶▶ The Portal page (main page) will be displayed. **▶Remote UI Screen(P. 416)**

**Remote UI Screen**

When you log in to the Remote UI, the following Portal page appears. This section describes the items displayed on the Portal page and the basic operations.

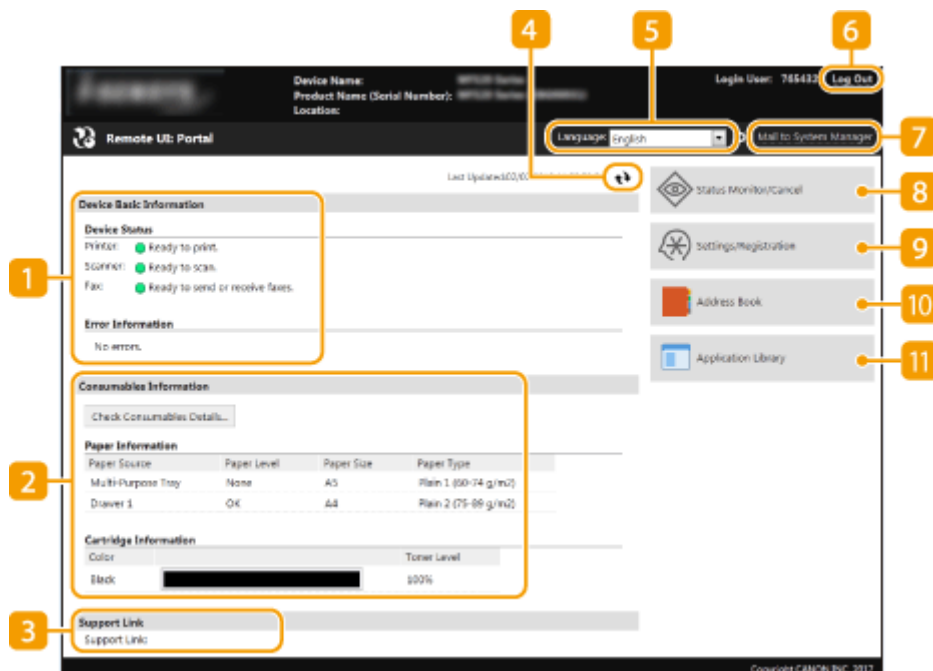

**1 [Device Basic Information]**

Displays the current status of the machine and error information. If an error has occurred, the link to the Error Information page will be displayed.

**2 [Consumables Information]**

Displays paper information and the amount remaining in the toner cartridges.

**3 [Support Link]**

Displays the support link specified in [Support Link] under [License/Other].



#### **4 Refresh Icon**

Refreshes the currently displayed page.

#### **5 [Language]**

Selects the display language used for the Remote UI screens.

#### **6 [Log Out]**

Logs off from the Remote UI. The Login page will be displayed.

#### **7 [Mail to System Manager]**

Displays a window for creating an e-mail to the system manager specified in [System Manager Information] under [User Management].

#### **8 [Status Monitor/Cancel]**

Displays the [Status Monitor/Cancel] page. For any of the waiting documents, you can check the status/history or cancel the processing.

#### **9 [Settings/Registration]**

Displays [Settings/Registration] page. When you have logged in to System Manager Mode, you can change the settings items and save/load the registered data. **▶Setting Up Menu Options from Remote UI(P. 424)**

#### **10 [Address Book]**

Displays the coded dial numbers and the Favorites list registered in the Address Book. You can also register or edit the Address Book when you have logged in to System Manager Mode. **▶Registering Destinations from Remote UI(P. 427)**

#### **11 [Application Library]**

Displays the Application Library setting page.

## Checking the Status and Logs

261J-082

- ▶ Checking Current Status of Print Documents(P. 418)
- ▶ Checking Current Status of Received Documents(P. 419)
- ▶ Checking History of Documents(P. 419)
- ▶ Checking Information of Documents That Failed To Be Forwarded(P. 419)
- ▶ Checking Error Information(P. 420)
- ▶ Checking Consumables(P. 420)
- ▶ Checking Device Specifications(P. 421)
- ▶ Checking System Manager Information(P. 421)
- ▶ Checking Print Total Counter(P. 422)
- ▶ Checking History of Toner Cartridges(P. 422)
- ▶ Checking Usage Status of the Machine(P. 423)

### NOTE

- A file name of a document may not be displayed in full. The printed application name may be added to the file name.

## Checking Current Status of Print Documents

The list of the documents currently printing or waiting to be printed is displayed.



Log in to the Remote UI ( ▶ **Starting Remote UI(P. 415)** ) ▶ [Status Monitor/Cancel] ▶ [[Job Status] in [Print]

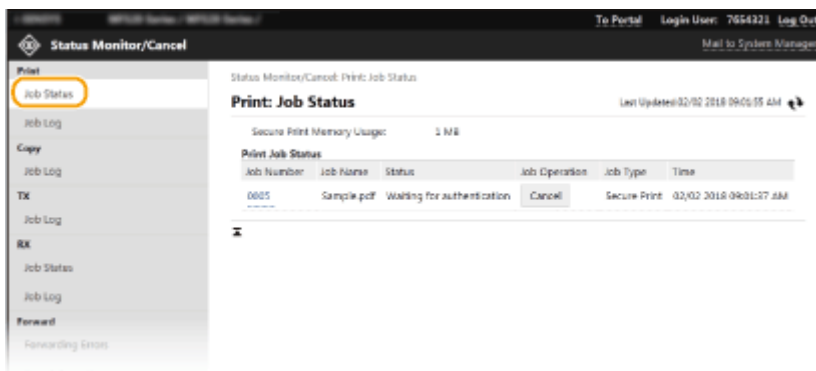

- You can delete a document job by clicking [Cancel].

### NOTE

- Regardless of the Department ID Management setting, all the print documents currently printing and waiting to be printed will be listed.
- If you entered your user name when you logged on in General User Mode, your user name will only be displayed on the documents that you printed.

- Click [Job Number] on the paused documents and secure documents to display detailed information. You can check the user name and the page count of the printed document.

## Checking Current Status of Received Documents

You can check the logs of received fax and I-Fax documents. You can also click [Delete] for a received fax document to delete it.



Log in to the Remote UI ( ▶ **Starting Remote UI(P. 415)** ) ▶ [Status Monitor/Cancel] ▶ [Job Status] in [RX]

### NOTE

- To perform the following operations for a received fax document, you need to log on in System Manager Mode and set <Use Fax Preview> to <On>.
  - Click [Print All] to print all received documents.
  - Click [Print] to print a document waiting to be printed.
  - Click [Job Number] to display detailed information and preview of a document waiting to be printed.

## Checking History of Documents

The job logs of print, copy, sending (TX), and receiving (RX) are displayed.



Log in to the Remote UI ( ▶ **Starting Remote UI(P. 415)** ) ▶ [Status Monitor/Cancel] ▶ [Job Log]

Job Number	Result	Start Time	End Time	Job Type	File Name	User Name	Original Pages	Output
0001	error	05/02 2018 12:23:44 AM	02/02 2018 09:01:05 AM	Printer	sample.pdf	User	3	0
0004	OK	05/02 2018 12:23:37 AM	05/02 2018 12:52:25 AM	Printer	sample_01.pdf	User	3	3
0003	OK	05/02 2018 12:25:25 AM	05/02 2018 12:26:53 AM	Printer	Full page photo	User	1	1

## Checking Information of Documents That Failed To Be Forwarded

Information of documents that failed to be forwarded is displayed.



Log in to the Remote UI ( ▶ **Starting Remote UI(P. 415)** ) ▶ [Status Monitor/Cancel] ▶ [Forwarding Errors]

## NOTE

- When you have logged on in System Manager Mode, you can click [Delete] to delete documents that failed to be forwarded.
- When you have logged on in System Manager Mode, you can click [Job Number] to display detailed information or preview of the document that failed to be forwarded.

## Checking Error Information

When an error occurs, this page will be displayed by clicking the message displayed under [Error Information] on the Portal page (main page). **Remote UI Screen(P. 416)**



Log in to the Remote UI ( **Starting Remote UI(P. 415)** ) ▶ [Status Monitor/Cancel] ▶ [Error Information]

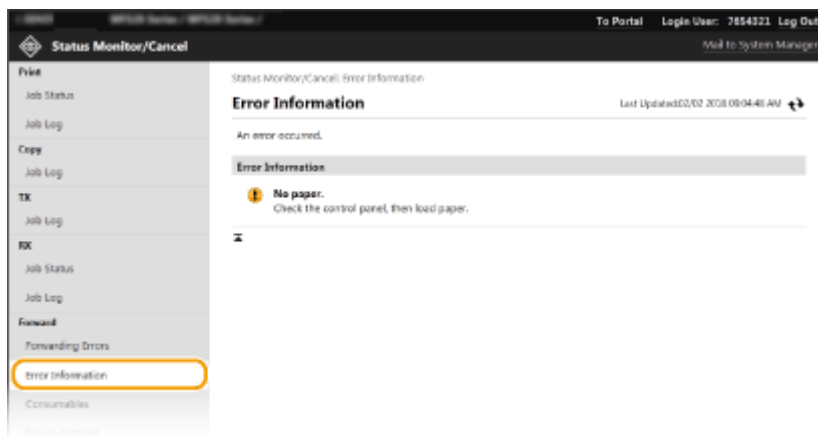

## Checking Consumables

Paper size and paper type for the paper source, toner cartridge model number, etc. are displayed. You can also click [Check Consumables Details] in the Portal page (main page) to display this page ( **Remote UI Screen(P. 416)** ).



Log in to the Remote UI ( **Starting Remote UI(P. 415)** ) ▶ [Status Monitor/Cancel] ▶ [Consumables]

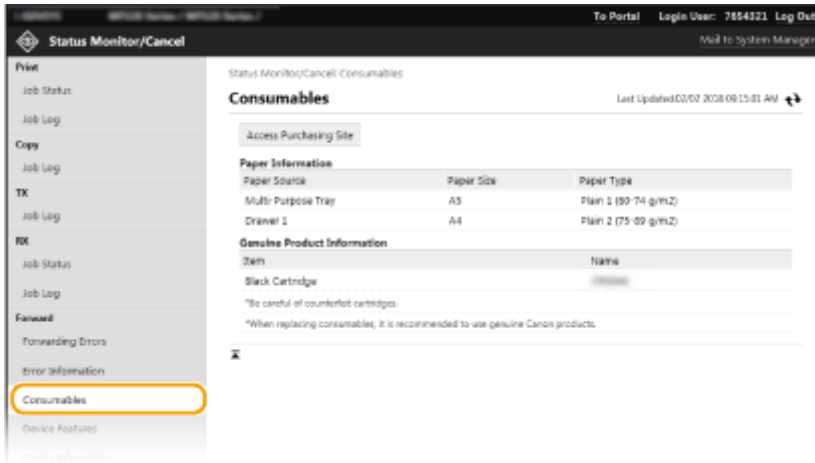

## Checking Device Specifications

The maximum print speed and machine features are displayed.



Log in to the Remote UI ( [▶ Starting Remote UI\(P. 415\)](#) ) ▶ [Status Monitor/Cancel] ▶ [Device Features]

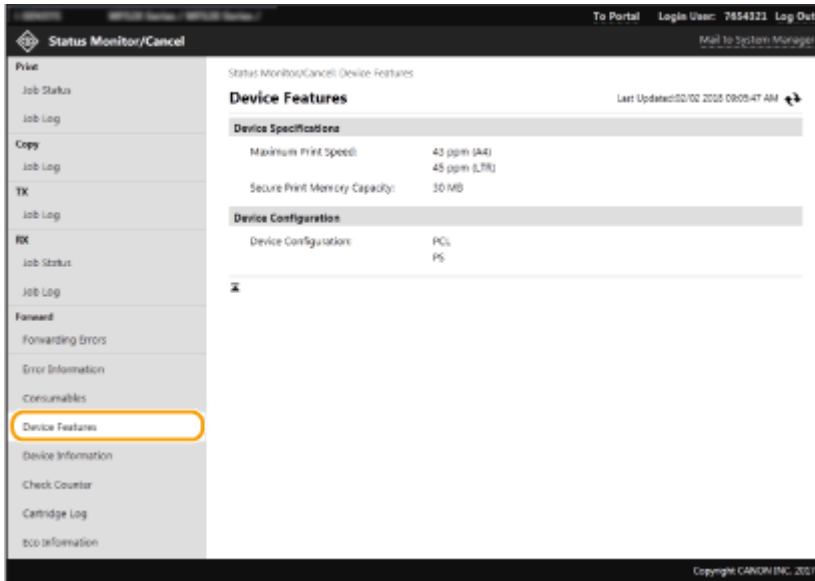

## Checking System Manager Information

Information about the machine and the system manager is displayed. The device name and other system manager information displayed here correspond to the settings in [System Manager Information] on the [User Management] page or in [Device Information Settings] on the [Device Management] page.



Log in to the Remote UI ( [▶ Starting Remote UI\(P. 415\)](#) ) ▶ [Status Monitor/Cancel] ▶ [Device Information]

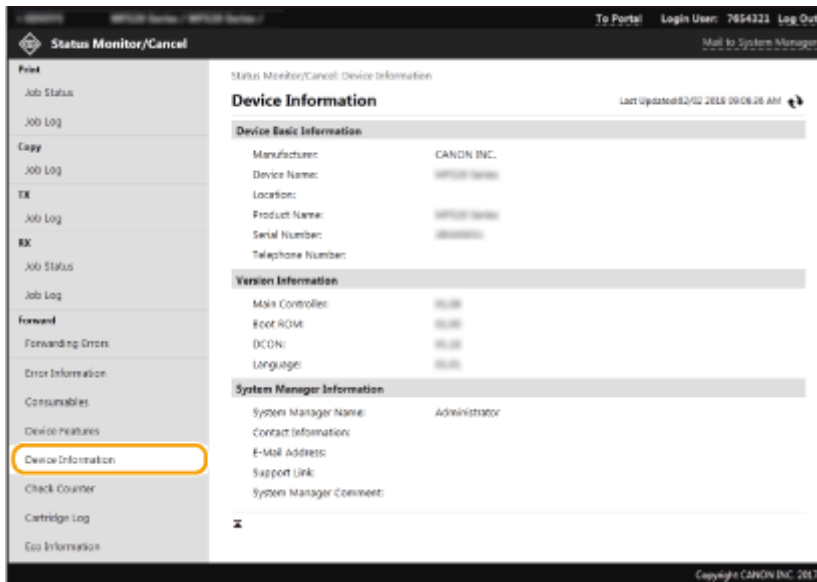

## Checking Print Total Counter

The total number of pages that have been printed by the copy, print, and fax functions is displayed.



Log in to the Remote UI ( ▶ **Starting Remote UI(P. 415)** ) ▶ [Status Monitor/Cancel] ▶ [Check Counter]

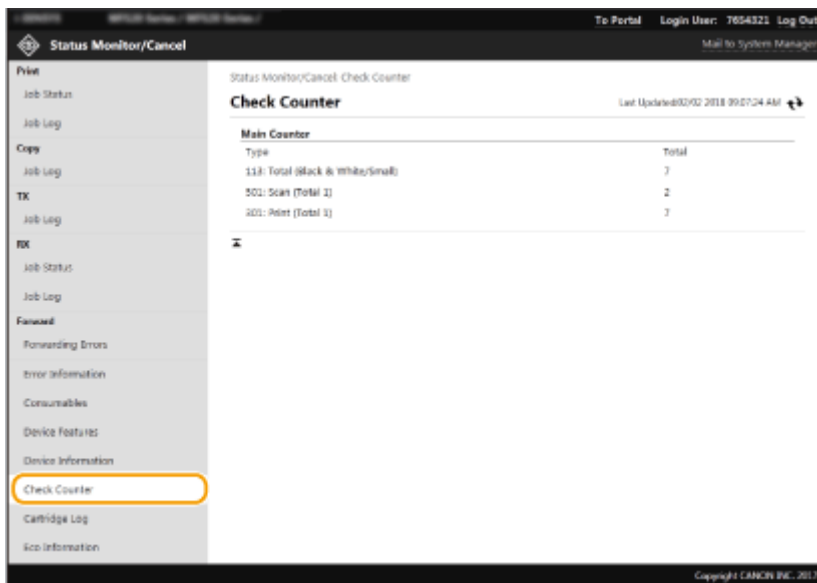

## Checking History of Toner Cartridges

You can check the usage logs of toner cartridges and other logs.



Log in to the Remote UI ( ▶ **Starting Remote UI(P. 415)** ) ▶ [Status Monitor/Cancel] ▶ [Cartridge Log]

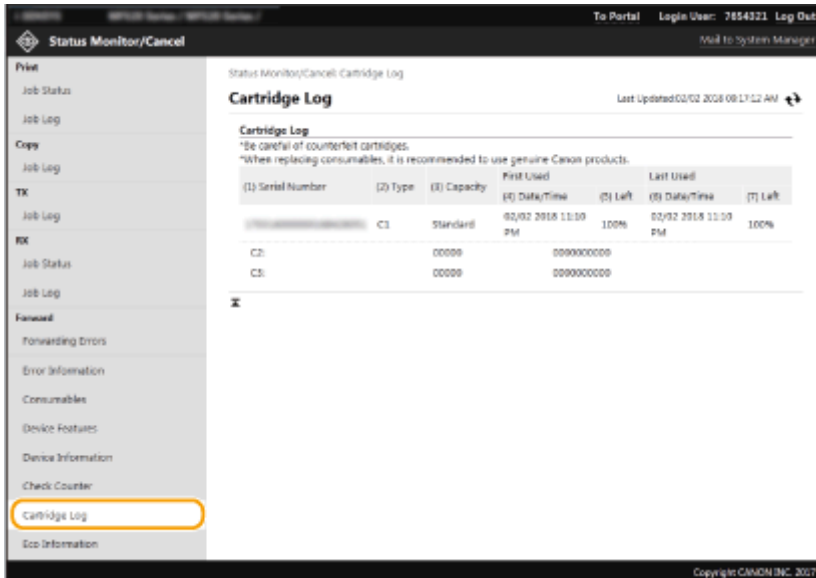

## Checking Usage Status of the Machine

The monthly total volume of printouts and monthly total power consumption are displayed. You can display the Eco Information screen and change the settings to save paper and power consumption.



Log in to the Remote UI ( ▶ **Starting Remote UI(P. 415)** ) ▶ [Status Monitor/Cancel] ▶ [Eco Information]

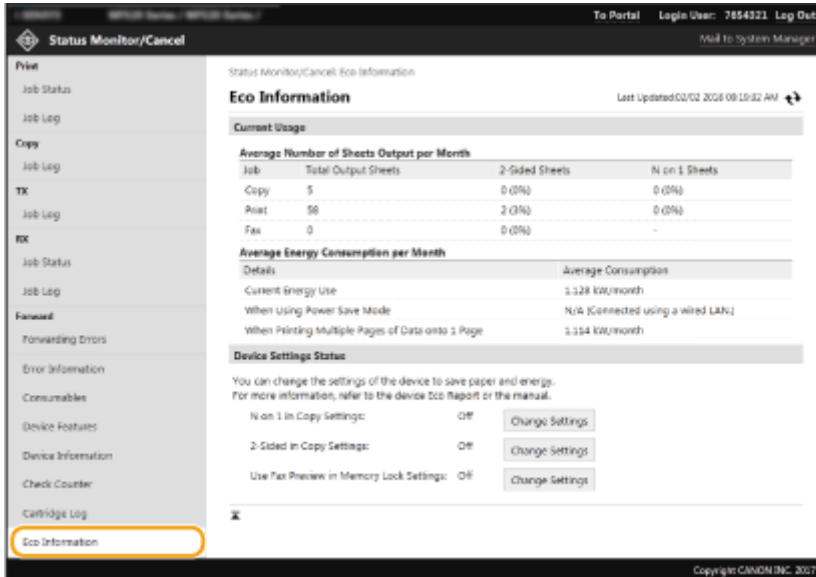

**LINKS**

▶ **Remote UI Screen(P. 416)**

# Setting Up Menu Options from Remote UI

261J-083

You can change the various machine settings by using the Remote UI. Most of the settings can be set also on the machine, but some settings can only be set using the Remote UI. This section describes the basic flow of changing the settings of the machine using the Remote UI.

## NOTE

- Some settings can only be changed when you have logged in to System Manager Mode.
- Some settings may require operations that differ from the procedure described here.

- 1 Start the Remote UI. ▶Starting Remote UI(P. 415)**
- 2 Click [Settings/Registration] on the Portal page. ▶Remote UI Screen(P. 416)**
- 3 Click the setting you want to configure in the menu on the left side of the screen.**

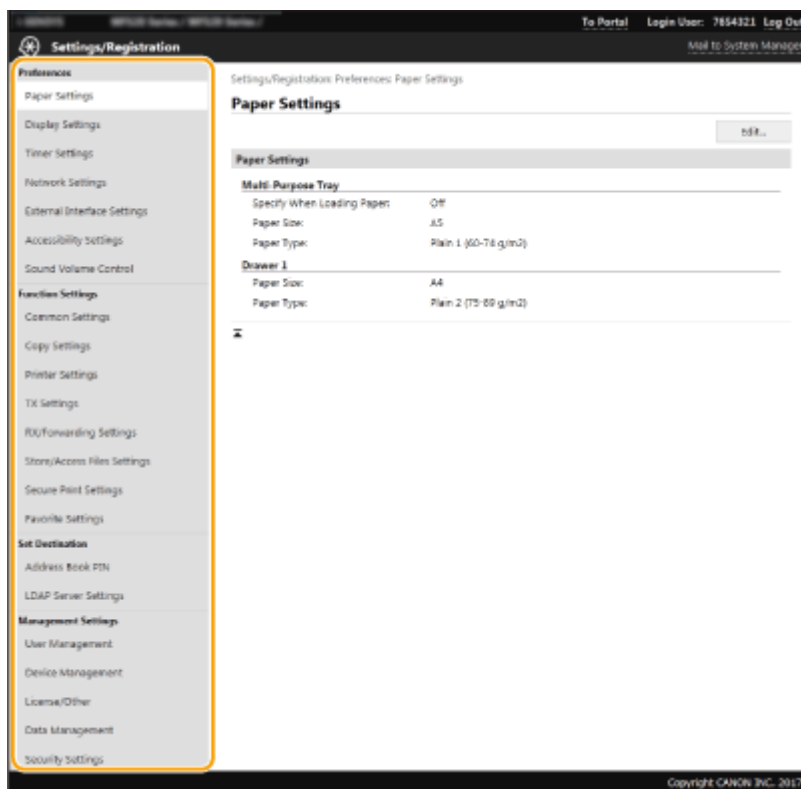

- 4 Click the link to display the desired page as necessary.**



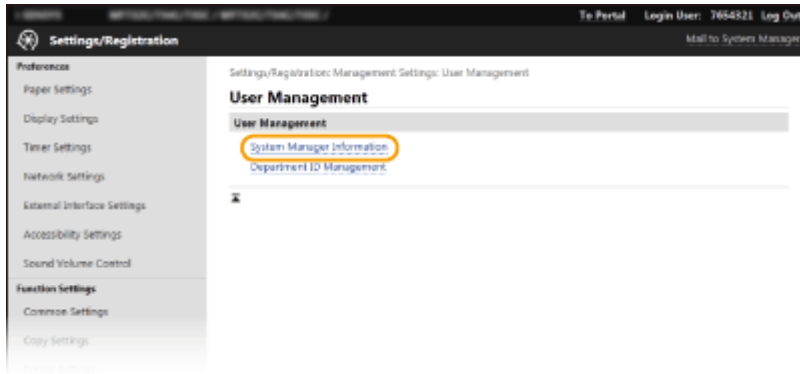

**5** Click [Edit].

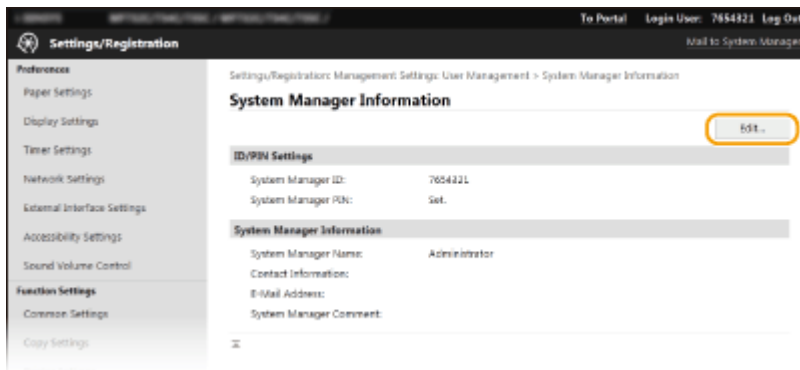

**6** Specify the required settings.

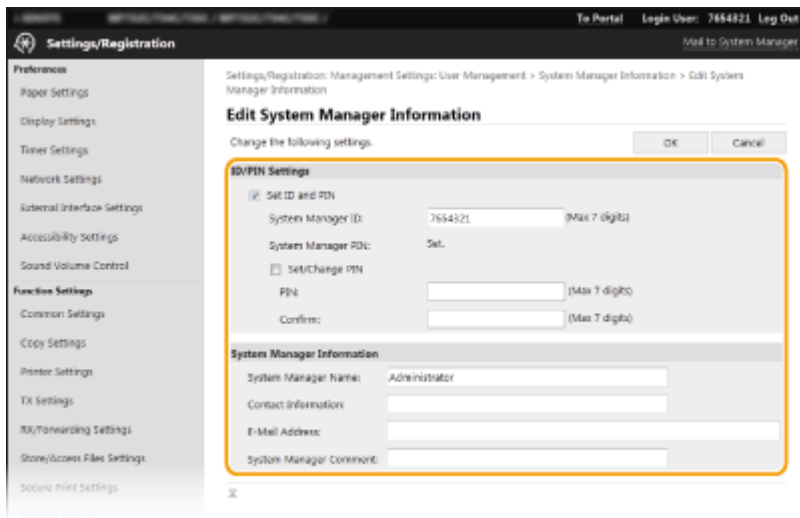

**7** Click [OK].

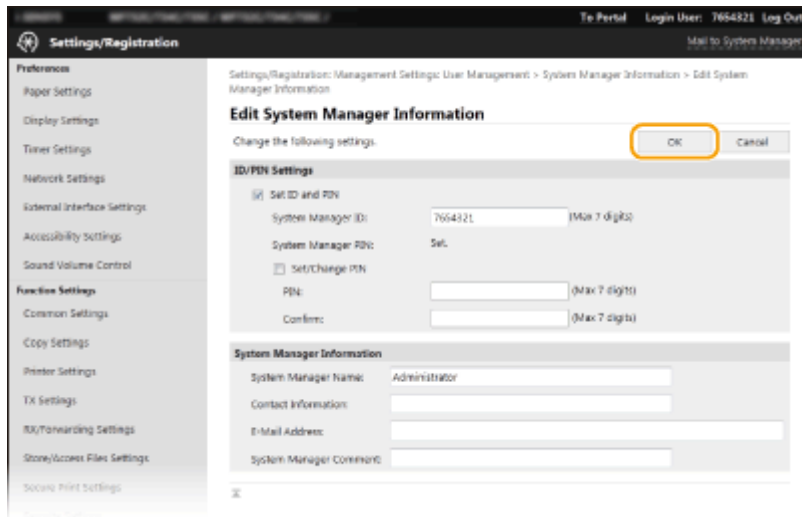

## 8 Restart the machine as necessary.

- Turn OFF the machine, wait for at least 10 seconds, and turn it back ON.

### NOTE:

- For information about whether you need to restart the machine, view the message on the edit screen.

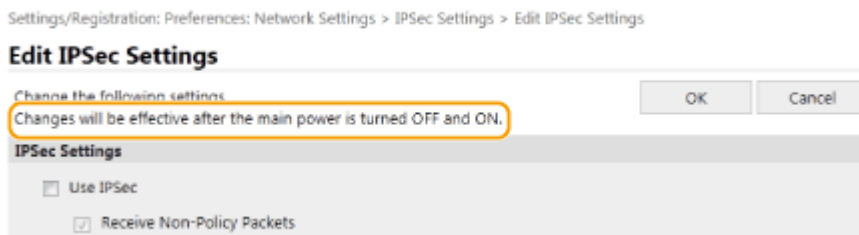

# Registering Destinations from Remote UI

261J-084

You can use the computer to register destinations in the Address Book of the machine and edit information of registered destinations. Specify the shared folder or FTP server destination here.

## NOTE

- You can change the settings only when you have logged in to System Manager Mode.

### 1 Start the Remote UI. ▶Starting Remote UI(P. 415)

### 2 Click [Address Book] on the Portal page. ▶Remote UI Screen(P. 416)

#### NOTE:

If the enter PIN page is displayed

- The Address Book is protected by a PIN. Enter the [PIN] and click [OK].

### 3 Click [Coded Dial].

- You can also register destinations in Favorites. In this case, click [Favorites] instead of [Coded Dial]. ▶Favorites(P. 176)

### 4 Click the text link under [Number], [Type], or [Name] for an item named "Not Registered."

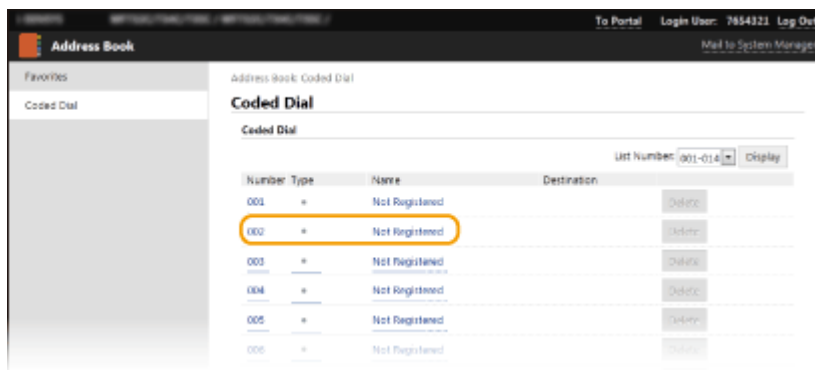

#### NOTE:

- You can edit a registered item by clicking the corresponding text link under [Number], [Type] or [Name].
- You can delete a registered destination by clicking the corresponding [Delete] button.
- If you delete a destination from the Address Book, it is also deleted from the favorite settings. ▶Registering Frequently Used Settings(P. 168)

### 5 Select the type of the destination to register, and click [OK].

- To register the shared folder or FTP server destination, select [File].

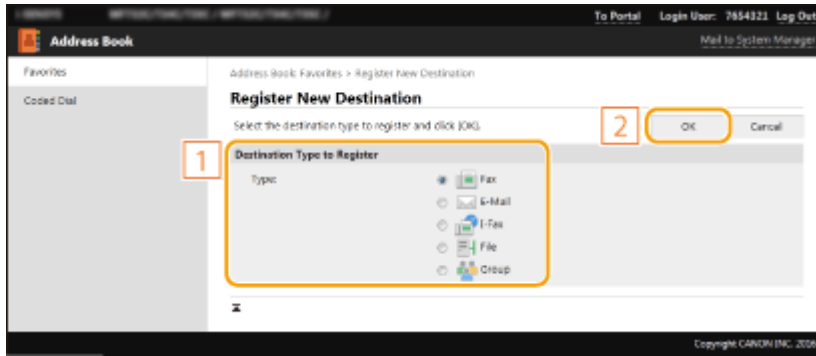

## 6 Specify the destination.

### ■ To register the fax destination

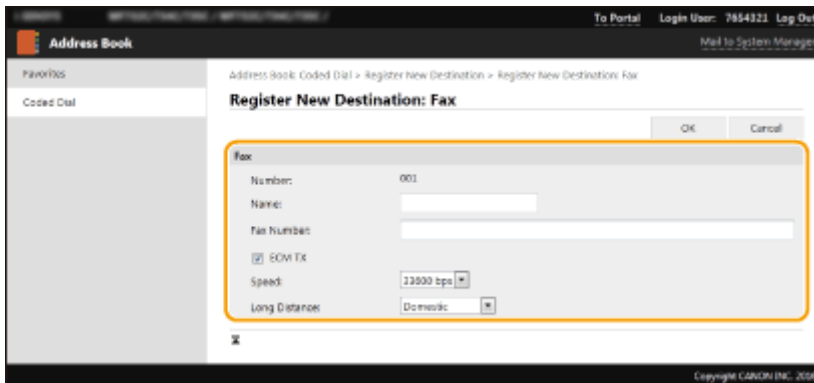

#### [Name]

Enter the name of the destination.

#### [Fax Number]

Enter the fax number of the destination.

#### [ECM TX]

Select the check box to make the following possible: if an error occurs in an image that is being sent, the error is checked and corrected to prevent an improper image from being sent.

#### [Speed]

If it takes time for transmissions to start, such as when there is a poor telephone connection, you can adjust the transmission start speed downward.

#### [Long Distance]

Specify [International (1)] to [International (3)] according to the transmission conditions when registering overseas fax numbers.

### NOTE:

- You can also specify [ECM TX] and [Speed] from <Fax Settings> (  <Send>(P. 517) ) on the operation panel. However, settings made from <Address Book> are enabled for the detailed settings of destinations registered in the Address Book.

**■ To register the e-mail or I-Fax destination**

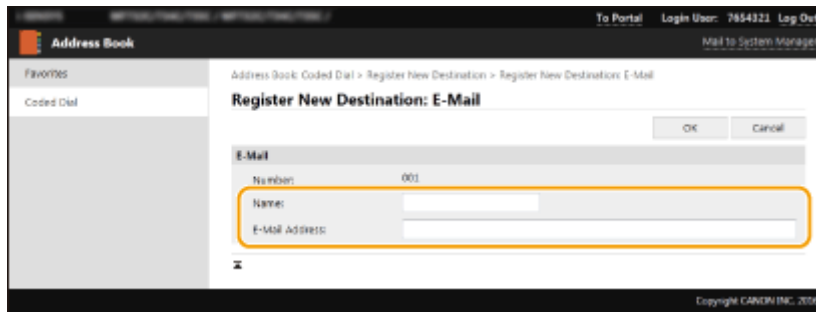

**[Name]**

Enter the name of the destination.

**[E-Mail Address]/[I-Fax Address]**

Enter the e-mail address of the destination.

**■ To register the shared folder or FTP server destination**

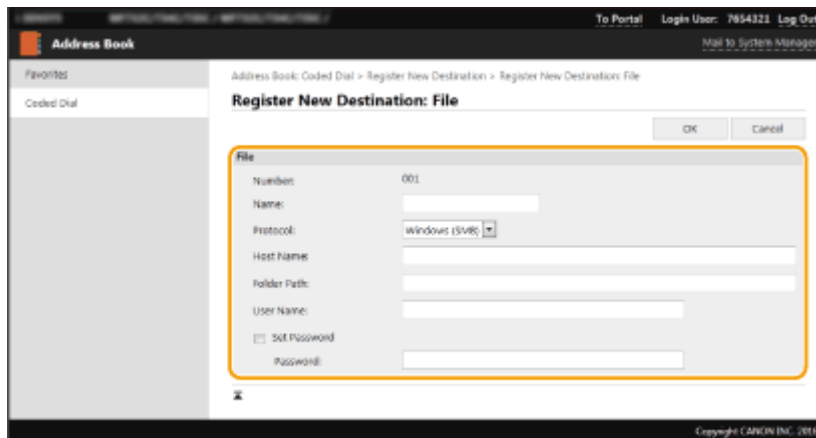

**[Name]**

Enter the name for the destination.

**[Protocol]**

Select the protocol for the destination.

[Windows (SMB)]	Select this when registering a shared folder as a destination.
[FTP]	Select this when registering an FTP server as a destination.

**[Host Name]**

- **For a shared folder**

Enter the computer name or IP address. You can include a path to the shared folder with the computer name or IP address (e.g. "\\swan\share" or "\\192.168.2.100\share").

- **For an FTP server**

Enter the IP address of the FTP server (e.g. "192.168.2.100").

**NOTE:**

**Using a DNS server**

- You can also enter the host name (or FQDN) instead of the computer name or IP address (e.g. for a shared folder: "\\swan.organization.company.com\share").

**[Folder Path]**

Enter the location of the folder to which the data will be sent.

- **For a shared folder**  
Use "\" as a separator. Specify the level that follows the path specified in [Host Name].
- **For an FTP server**  
Use "/" as a separator. The path is an absolute path when a "/" is placed at its top, otherwise a relative path with respect to the current directory of the user who has logged in.

**[User Name]**

Enter the user name set for the shared folder or FTP server.

**[Set Password]**

To set a password for the shared folder or FTP server, select the check box and enter a [Password].

## IMPORTANT

**Ensure that the same display language is selected on both the computer and the Remote UI.**

- [Host Name] and [Folder Path] may not be displayed correctly or may not be referenceable.

## 7 Click [OK].

### LINKS

---

- ▶ **Remote UI Screen(P. 416)**
- ▶ **Importing/Exporting the Setting Data(P. 437)**
- ▶ **Address Book List(P. 583)**

# Security Policy

261J-0E1

It is a common practice for organizations to adopt a security policy that defines basic information security objectives and standards, which requires information devices such as computers and multifunctional printers to be operated accordingly. If you have a security policy to be applied in your organization, apply it to this machine as well.



- ▶ **Viewing the Security Policy(P. 431)**
- ▶ **Security Policy Items(P. 431)**
- ▶ **To Apply the Security Policy to the Machine(P. 435)**

## Viewing the Security Policy

You can view the security policy set in the machine using the Remote UI.

- 1 Start the Remote UI. ▶Starting Remote UI(P. 415)**
- 2 Click [Settings/Registration] on the Portal page. ▶Remote UI Screen(P. 416)**
- 3 Click [Security Settings] ▶ [Confirm Security Policy].**

## Security Policy Items

The following items are displayed by the Remote UI. The items for functions unavailable on this machine are also displayed, but do not affect the machine operation.

### ■ [Interface]

#### [Wireless Connection Policy]

Prevent unauthorized access by prohibiting wireless connections.

[Prohibit Use of Direct Connection]	<Use Direct Connection> is set to <Off>. It is not possible to access the machine from mobile devices.	▶<Direct Connection Settings>(P. 458)
[Prohibit Use of Wireless LAN]	<Select Wired/Wireless LAN> is set to <Wired LAN>. It is not possible to establish a wireless connection with the machine via a wireless LAN router or access point.	▶<Select Wired/Wireless LAN>(P. 457)

#### [USB Policy]

Prevent unauthorized access and data breaches by prohibiting USB connection.

[Prohibit Use as USB Device]	<Use as USB Device> is set to <Off>. It is not possible to connect to a computer via USB.	▶<Use as USB Device>(P. 471)
[Prohibit Use as USB Storage Device]	<Use USB Storage Device> is set to <Off>. It is not possible to use USB memory devices.	▶<Use USB Storage Device>(P. 471)

## ■ [Network]

### [Communication Operational Policy]

Increase the security of communications by requiring the verification of signatures and certificates.

[Always Verify Signatures for SMS/ WebDAV Server Functions]	This function is not available on this machine, giving no change to the security level.	—
[Always Verify Server Certificate When Using TLS]	<p>The following settings in [Use TLS for SMTP] and [Use TLS for POP] are set to [On].</p> <ul style="list-style-type: none"> <li>• [Verify Certificate]</li> <li>• [Add CN to Verification Items]</li> </ul> <p>The following settings in [Use Google Cloud Print] are set to [On].</p> <ul style="list-style-type: none"> <li>• [Verify Server Certificate]</li> <li>• [Add CN to Verification Items]</li> </ul> <p>The following settings in [Confirm TLS Certificate for LDAP Server Access] of [LDAP Server (For Search)] and [LDAP Server (For Authentication)] are set to [On].</p> <ul style="list-style-type: none"> <li>• [Confirm TLS Certificate for LDAP Server Access]</li> <li>• [Add CN to Verification Items]</li> </ul>	<p>▶&lt;Configuring E-Mail/I-Fax Communication Settings&gt;(P. 90)</p> <p>▶&lt;Registering the Machine with Google Cloud Print&gt;(P. 341)</p> <p>▶&lt;Registering LDAP Servers&gt;(P. 64)</p>
[Prohibit Cleartext Authentication for Server Functions]	<Dedicated Port Auth. Method> is set to <Mode 2>. When using the machine as a server, plain text authentication and functions that use plain text authentication are not available.	▶<Dedicated Port Auth. Method>(P. 467)
[Prohibit Use of SNMPv1]	In <SNMP Settings>, <SNMPv1 Settings> is set to <Off>. It is not possible to use SNMPv1 when obtaining device information from the computer.	▶<SNMP Settings>(P. 466)

## NOTE

- This setting does not apply to communication with IEEE 802.1X networks, even if [Always Verify Server Certificate When Using TLS] is set to [On].
- If [Prohibit Cleartext Authentication for Server Functions] is set to [On] and your device management software or driver version is old, it may not be possible to connect to the machine. Ensure that you are using the latest versions.

### [Port Usage Policy]

Prevent external breaches by closing unused ports.

[Restrict LPD Port (Port Number: 515)]	In <LPD Settings>, <Use LPD Printing> is set to <Off>. It is not possible to perform LPD printing.	▶<LPD Settings>(P. 463)
[Restrict RAW Port (Port Number: 9100)]	In <RAW Settings>, <Use RAW Printing> is set to <Off>. It is not possible to perform RAW printing.	▶<RAW Settings>(P. 464)



## Managing the Machine

[Restrict FTP Port (Port Number: 21)]	This function is not available on this machine, giving no change to the security level.	—
[Restrict WSD Port (Port Number: 3702, 60000)]	The following settings in <WSD Settings> are set to <Off>. It is not possible to use WSD functions. <ul style="list-style-type: none"> <li>• &lt;Use WSD Printing&gt;</li> <li>• &lt;Use WSD Browsing&gt;</li> <li>• &lt;Use WSD Scanning&gt;</li> <li>• &lt;Use Computer Scanning&gt;</li> <li>• &lt;Use Multicast Discovery&gt;</li> </ul>	🔴<WSD Settings>(P. 464)
[Restrict BMLinkS Port (Port Number: 1900)]	This function is not available on this machine, giving no change to the security level.	—
[Restrict IPP Port (Port Number: 631)]	Part of the settings to enable printing from mobile devices using applications will be turned <Off>, disabling part of printing from mobile devices using applications.	🔴Linking with Mobile Devices(P. 319)
[Restrict SMB Port (Port Number: 137, 138, 139, 445)]	This function is not available on this machine, giving no change to the security level.	—
[Restrict SMTP Port (Port Number: 25)]	This function is not available on this machine, giving no change to the security level.	—
[Restrict Dedicated Port (Port Number: 9002, 9006, 9007, 9011-9015, 9017-9019, 9022, 9023, 9025, 20317, 47545-47547)]	<Use Dedicated Port> is set to <Off>. It is not possible to use dedicated ports.	🔴<Use Dedicated Port>(P. 467)
[Restrict Remote Operator's Software Port (Port Number: 5900)]	This function is not available on this machine, giving no change to the security level.	—
[Restrict SIP (IP Fax) Port (Port Number: 5004, 5005, 5060, 5061, 49152)]	This function is not available on this machine, giving no change to the security level.	—
[Restrict mDNS Port (Port Number: 5353)]	The following settings will be turned <Off>, and part of the settings to enable printing from mobile devices using applications will also be turned <Off>. It will be disabled to search the network or perform automatic settings using mDNS. In addition, part of printing from mobile devices using applications will be disabled as well. <ul style="list-style-type: none"> <li>• &lt;mDNS Settings&gt; ▶ &lt;IPv4&gt; ▶ &lt;Use mDNS&gt;</li> <li>• &lt;mDNS Settings&gt; ▶ &lt;IPv6&gt; ▶ &lt;Use mDNS&gt;</li> <li>• [Use Google Cloud Print] ▶ [Local Print]</li> </ul>	🔴<mDNS Settings>(P. 463) 🔴Registering the Machine with Google Cloud Print(P. 341) 🔴Linking with Mobile Devices(P. 319)
[Restrict SLP Port (Port Number: 427)]	In [Multicast Discovery Settings], [Discovery Response] is set to [Off]. It is not possible to search the network or perform automatic settings using SLP.	🔴Configuring SLP Communication with Device Management Software(P. 75)
[Restrict SNMP Port (Port Number: 161)]	In <SNMP Settings>, the <SNMPv1 Settings> and <SNMPv3 Settings> are set to <Off>, and <Scan w/ Canon PRINT Business> is set to <Off>. It is not possible to obtain device information from the computer or configure settings using SNMP.	🔴<SNMP Settings>(P. 466) 🔴<Scan w/ Canon PRINT Business>(P. 548)

■ [Authentication]

[Authentication Operational Policy]

[Prohibit Guest Users to Use Device]	This function is not available on this machine, giving no change to the security level.	—
[Force Setting of Auto Logout]	This function is not available on this machine, giving no change to the security level.	—

[Password Operational Policy]

[Prohibit Caching of Password for External Servers]	This function is not available on this machine, giving no change to the security level.	—
[Display Warning When Default Password Is in Use]	This function is not available on this machine, giving no change to the security level.	—
[Prohibit Use of Default Password for Remote Access]	This function is not available on this machine, giving no change to the security level.	—

[Password Settings Policy]

[Minimum Number of Characters for Password]	This function is not available on this machine, giving no change to the security level.	—
[Password Validity Period]	This function is not available on this machine, giving no change to the security level.	—
[Prohibit Use of 3 or More Identical Consecutive Characters]	This function is not available on this machine, giving no change to the security level.	—
[Force Use of at Least 1 Uppercase Character]	This function is not available on this machine, giving no change to the security level.	—
[Force Use of at Least 1 Lowercase Character]	This function is not available on this machine, giving no change to the security level.	—
[Force Use of at Least 1 Digit]	This function is not available on this machine, giving no change to the security level.	—
[Force Use of at Least 1 Symbol]	This function is not available on this machine, giving no change to the security level.	—

[Lockout Policy]

Block users from logging in for a specified period of time after a certain number of consecutive invalid login attempts.

[Enable Lockout]	In <Lockout>, <Enable Lockout> is set to <On>. Specify the values for <Lockout Threshold> and <Lockout Period>.	▶<Lockout>(P. 554)
------------------	---	--------------------

■ [Key/Certificate]

Protect important data by preventing the use of weak encryption, or by saving encrypted user passwords and keys in a designated hardware component.

[Prohibit Use of Weak Encryption]	<Prohibit Use of Weak Encrypt.> is set to <On>. It is not possible to use weak encryption.	▶<Encryption Settings>(P. 554)
-----------------------------------	--	--------------------------------

## Managing the Machine

[Prohibit Use of Key/Certificate with Weak Encryption]	In <Prohibit Use of Weak Encrypt.>, <Prohibit Weak Encryp. Key/Cert.> is set to <On>. It is not possible to use a key or certificate with weak encryption.	🔴<Encryption Settings>(P. 554)
[Use TPM to Store Password and Key]	This function is not available on this machine, giving no change to the security level.	—

### ■ [Log]

[Force Recording of Audit Log]	This function is not available on this machine, giving no change to the security level.	—
[Force SNTP Settings]	This function is not available on this machine, giving no change to the security level.	—

### ■ [Job]

#### [Printing Policy]

[Prohibit Immediate Printing of Received Jobs]	This function is not available on this machine, giving no change to the security level.	—
--	---	---

#### [Sending/Receiving Policy]

Limit the sending operations for destinations, and limit how received data is processed.

[Allow Sending Only to Registered Addresses]	<Restrict New Destinations> is set to <On>. It is only possible to send to destinations that are registered in the Address Book.	🔴<Restrict New Destinations>(P. 517)
[Force Confirmation of Fax Number]	<Confirm Entered Fax Number> is set to <On>. Users are required to enter a fax number again for confirmation when sending a fax.	🔴<Confirm Entered Fax Number>(P. 526)
[Prohibit Auto Forwarding]	In <Forwarding Function>, the <Use Forwarding Function> is set to <Off>. It is not possible to automatically forward faxes.	🔴<Forwarding Settings>(P. 534)

### ■ [Storage]

[Force Complete Deletion of Data]	This function is not available on this machine, giving no change to the security level.	—
-----------------------------------	---	---

## To Apply the Security Policy to the Machine

You can import the security policy edited on the imageRUNNER ADVANCE Series or using Device Management Software to apply it to this machine. In addition, you can export the security policy as applied to this machine to apply it to other machines\*. 🔴**Importing/Exporting the Setting Data(P. 437)**

\*Only Canon devices that are compatible with security policy settings

## NOTE

- The security policy settings can only be imported if the security policy setting password on the exporting machine matches that of the importing machine, or if no password has been set for the importing machine. If no password has been set for the importing machine, the password configured for the exporting machine is set to the importing machine.
- You cannot set or change the security policy on this machine.

# Importing/Exporting the Setting Data

261J-085

Address Book and machine settings data can be saved on your computer (export). Data that is saved on your computer can also be registered in the machine (import). You can easily copy the destinations in the Address Book to multiple machines.\* To use these features, it is required that you have logged in to System Manager Mode.

\*If using the same model, you can import/export machine settings data.

▶ **Exporting the Setting Data(P. 437)**

▶ **Importing the Setting Data(P. 438)**

## IMPORTANT

### Do not turn OFF the machine until the import or export process is complete

- It may take a few minutes to complete the process. If the machine is turned OFF during the process, it may result in damage to data or the machine.

### Do not operate the machine during the import or export process

- Before importing/exporting, check that no operation such as printing documents is currently proceeding.

## NOTE

- For the settings that cannot be imported/exported, see ▶ **Setting Menu List(P. 445)** .
- You can also import/export settings data via a USB memory device by using the operation panel of the machine. ▶ **<Import/Export>(P. 552)**
- For more information about the basic operations to be performed when setting the machine from the Remote UI, see ▶ **Setting Up Menu Options from Remote UI(P. 424)** .

## Exporting the Setting Data

You can export Address Book and machine settings data, and save them on a computer. You can export Address Book data as a device configuration information file (\*.dcm) or Canon Address Book file (\*.abk). Select the device configuration information file type to save the data as a backup copy or copy the Address Book data to the same machine model. Select the Canon Address Book file type to copy the Address Book data to the fax driver or a different machine model. It is recommended that you regularly back up important settings.

- 1 Start the Remote UI and log in to System Manager Mode. ▶ Starting Remote UI(P. 415)**
- 2 Click [Settings/Registration] on the Portal page. ▶ Remote UI Screen(P. 416)**
- 3 Select [Data Management] ▶ [Export].**
- 4 Select the settings to export, and specify the encryption password.**

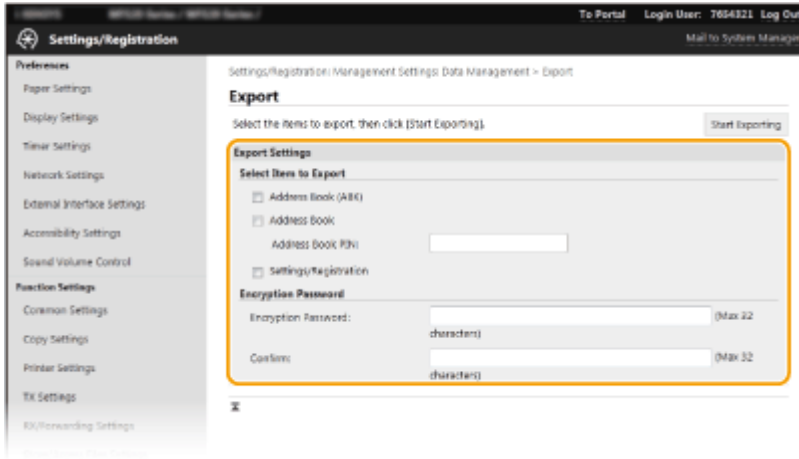

**[Address Book (ABK)]**

Select the check box to export the Address Book data as a Canon Address Book file (\*.abk).

**NOTE:**

- If the [Address Book (ABK)] check box is selected, you cannot export the settings of the machine at the same time with the Address Book data.

**[Address Book]**

Select the check box to export the Address Book data as a device configuration information file (\*.dcm).

**[Address Book PIN]**

If the Address Book is code-protected, enter the code for the Address Book. ▶ **Restricting Use of the Address Book(P. 401)**

**[Settings/Registration]**

Select the check box to export machine settings data.

**[Encryption Password]**

Enter a password to encrypt the export data using alphanumeric characters. Enter the same password in [Confirm]. If the [Address Book] or [Settings/Registration] check box is selected, the data cannot be exported without an encryption password set.

**NOTE:**

- The password is required when exported data is imported. ▶ **Importing the Setting Data(P. 438)**

**5 Click [Start Exporting].**

**6 Follow the on-screen instructions to specify the location where to save the exported data.**

⇒ The setting data will be saved.

**Importing the Setting Data**

Load (import) data that was exported from the machine. You can also import machine settings data from another machine to your machine if the models are the same.

**1 Start the Remote UI and log in to System Manager Mode. ▶ Starting Remote UI(P. 415)**

**2** Click [Settings/Registration] on the Portal page. ▶ Remote UI Screen(P. 416)

**3** Select [Data Management] ▶ [Import].

**4** Specify the file, enter the password, and select the settings to import.

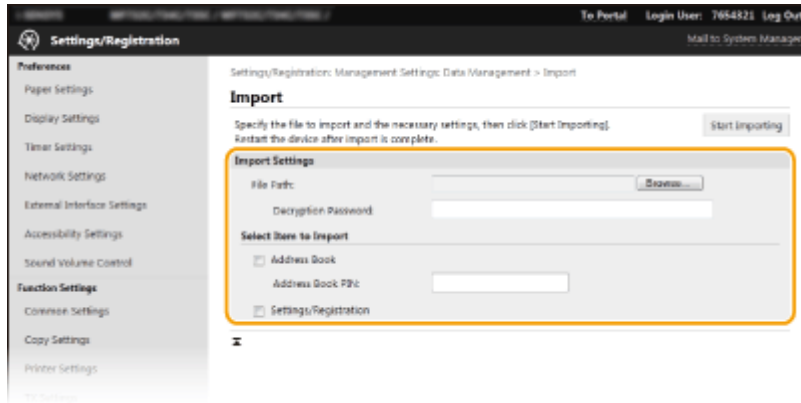

**[File Path]**

Click [Browse] and select the file. You can only import a device configuration information file (\*.dcm) and a Canon Address Book file (\*.abk). If you select the Canon Address Book file type, you do not need to set any other items.

**[Decryption Password]**

Enter the password set when the settings were exported.

**[Address Book]**

Select the check box to import Address Book data.

**IMPORTANT:**

- Importing Address Book data will overwrite the Address Book entries currently registered on the machine.

**[Address Book PIN]**

If the Address Book is code protected, enter the code for the Address Book. ▶ Restricting Use of the Address Book(P. 401)

**[Settings/Registration]**

Select the check box to import machine settings data.

**5** Click [Start Importing].

**6** Click [OK].

⇒ The selected settings data is loaded into the machine.

**7** Click [OK].

⇒ If the [Settings/Registration] check box is selected in step 4, the machine automatically restarts.

# Updating the Firmware

261J-086

For the firmware, select the method of update depending on the installation condition of the machine. There are two methods of update: the one is to access the latest firmware version on the Internet from the machine and perform the update if the version currently installed in the machine is not the latest, and the other is to access the latest firmware version on the Internet from a computer and perform the update from the computer if the version currently installed in the machine is not the latest. In an environment where connection to the Internet cannot be established via a wireless LAN, establish connection via a wired LAN or USB and perform the update from the computer.

Installation Condition of the Machine	How to Install the Update
Wireless LAN connection	▶ <b>Updating via the Internet(P. 440)</b>
Wired LAN connection	▶ <b>Updating via the Internet(P. 440)</b> ▶ <b>Updating from a Computer(P. 441)</b>
USB connection	▶ <b>Updating from a Computer(P. 441)</b>

## IMPORTANT

- If you are in an IPv6 environment, you cannot perform firmware update. Use USB to re-establish connection, and perform the update from the computer.

## NOTE

### Checking the firmware version

- You can check the firmware version from the operation panel of the machine. After completion of the firmware update operation, make sure that the update was performed correctly. ▶ **Checking the Firmware Version(P. 441)**

## Updating via the Internet

You can access the Canon server from the machine to update the firmware to the latest version.

### 1 Select <Update Firmware> in the Home screen. ▶ **Home Screen(P. 121)**

⇒ A check for existence of the latest firmware is performed.

#### NOTE:

- If the <This is the latest firmware version.> message is displayed, there is no need to update the firmware.

### 2 When a license screen appears, select <Accept>.

### 3 Select <OK>.

⇒ When the firmware update is complete, the machine restarts automatically.



## IMPORTANT:

- Do not turn OFF the machine while the restart is in progress.

## Updating from a Computer

When you have downloaded the latest firmware version from the Canon website, use "User Support Tool" utility software to update the firmware from a computer. For how to perform firmware update from a computer, see the "User Support Tool Operation Guide" included with the firmware.

### To Put the Machine into a Firmware Update Waiting State



## Checking the Firmware Version

**1** Select <Menu> in the Home screen. Home Screen(P. 121)

**2** Select <Management Settings>.

- If the login screen appears, enter the correct ID and PIN. Logging in to the Machine(P. 132)

**3** Select <License/Other> ▶ <Update Firmware>.

**4** Select <Version Information>.

⇒ The current firmware version is displayed.

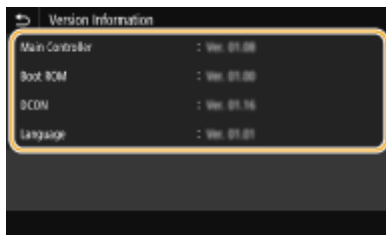

# Initializing Settings

261J-087



You can restore the following settings:

- ▶ **Initializing Menu (P. 442)**
- ▶ **Initializing Key and Certificate (P. 442)**
- ▶ **Initializing Address Book (P. 443)**
- ▶ **Initializing All Data/Settings (P. 443)**

## Initializing Menu

You can restore the settings of the machine ( ▶ **Setting Menu List (P. 445)** ). Depending on the settings selected, you may need to restart the machine after initialization.



<Menu> ▶ <Management Settings> ▶ <Data Management> ▶ <Initialize Menu> ▶ Select the item you want to initialize ▶ <Yes> ▶  (Restart the machine if necessary)

## NOTE

- You can restore the settings only for <Network> in <Preferences>.

<Menu> ▶ <Preferences> ▶ <Network> ▶ <Initialize Network Settings> ▶ <Yes> ▶ <OK> ▶ Restart the machine

## Initializing Key and Certificate

You can restore the settings of the key and certificate and the CA certificate. Note that all the keys and certificates and CA certificates that you registered in the machine (except the preinstalled keys and CA certificates) will be deleted after initializing.

## NOTE

- After initializing, functions that require a key and certificate such as TLS encrypted communication and IKE or IPsec communication are not available. To use these functions, configure the settings for the key and certificate and activate the functions again.



<Menu> ▶ <Management Settings> ▶ <Data Management> ▶ <Initialize Key and Certificate> ▶ <Yes> ▶ 

## Initializing Address Book

You can restore the settings of the Address Book. Note that all the information registered in the Address Book will be deleted after initializing.



<Menu> ▶ <Management Settings> ▶ <Data Management> ▶ <Initialize Address Book> ▶ <Yes> ▶ 

## Initializing All Data/Settings

This enables restoration of all data and machine settings, including logs, to the factory default values. This prevents sensitive data from being leaked when replacing or disposing of the machine. When the initialization process finishes, the machine automatically restarts.

### IMPORTANT

- Before initializing, make sure that there are no documents being processed or waiting to be processed. These documents will be deleted when initialization is performed.
- To use the machine after initializing it, you need to configure all settings from the beginning.



<Menu> ▶ <Management Settings> ▶ <Initialize All Data/Settings> ▶ <Yes> ▶ <Yes>

### LINKS

---

- ▶ [Configuring the Key and Certificate for TLS\(P. 376\)](#)
- ▶ [Registering Destinations\(P. 176\)](#)
- ▶ [Registering Destinations from Remote UI\(P. 427\)](#)

# Setting Menu List

<b>Setting Menu List</b> .....	445
<b>&lt;Preferences&gt;</b> .....	446
<Display Settings> .....	447
<English Keyboard Layout> .....	451
<Timer/Energy Settings> .....	452
<Network> .....	457
<External Interface> .....	471
<Accessibility> .....	472
<b>&lt;Adjustment/Maintenance&gt;</b> .....	473
<Adjust Image Quality> .....	474
<Maintenance> .....	482
<b>&lt;Function Settings&gt;</b> .....	483
<Common> .....	484
<Copy> .....	490
<Printer> .....	492
<Send> .....	517
<Receive/Forward> .....	529
<Store/Access Files> .....	536
<Secure Print> .....	542
<b>&lt;Set Destination&gt;</b> .....	543
<b>&lt;Management Settings&gt;</b> .....	544
<User Management> .....	545
<Device Management> .....	546
<License/Other> .....	550
<Data Management> .....	552
<Security Settings> .....	554

# Setting Menu List

261J-088

You can customize the machine based on your environment and needs by configuring settings described in this chapter. To start configuration, select <Menu> on the Home screen ( [▶Home Screen\(P. 121\)](#) ). This section describes what each item in the setting menu can configure.

<a href="#">▶&lt;Preferences&gt;(P. 446)</a>	This section describes the display and network settings.
<a href="#">▶&lt;Adjustment/Maintenance&gt;(P. 473)</a>	This section describes how to adjust print image quality and the cleaning functions of the machine.
<a href="#">▶&lt;Function Settings&gt;(P. 483)</a>	This section describes the settings for the individual functions.
<a href="#">▶&lt;Set Destination&gt;(P. 543)</a>	This section describes the Address Book settings.
<a href="#">▶&lt;Management Settings&gt;(P. 544)</a>	This section describes the user and hardware information management, security settings, etc.

## TIPS

- You can print the setting menu in list form to check the current settings: [▶Printing Lists of Settings\(P. 583\)](#)

## <Preferences>

---

261J-089

Item	Description
▶<Display Settings>(P. 447)	This section describes the settings related to viewing of the display.
▶<English Keyboard Layout>(P. 451)	This section describes the USB keyboard settings.
▶<Timer/Energy Settings>(P. 452)	This section describes the timer settings and energy settings.
▶<Network>(P. 457)	This section describes the network settings.
▶<External Interface>(P. 471)	This section describes the USB settings and other relevant settings.
▶<Accessibility>(P. 472)	This section describes settings for improving accessibility, such as inverting the screen colors and setting the message display time.

## <Display Settings>

All the settings related to viewing of the display are listed with descriptions. Default settings are marked with a dagger (+).

- ▶<Default Screen After Startup/Restoration>(P. 447)
- ▶<Home Screen Button Display Settings>(P. 447)
- ▶<Language>(P. 448)
- ▶<Remote UI Language>(P. 448)
- ▶<Notify to Clean Orig. Scan Area>(P. 449)
- ▶<Millimeter/Inch Entry Switch>(P. 449)
- ▶<Display Timing for Cart. Prep.>(P. 450)
- ▶<Display Notif. to Clean Fixing Assembly>(P. 450)

### NOTE

#### Asterisks (\*)

- Settings marked with "\*1" may not be displayed depending on the model you are using, options, or other setting items.
- Settings marked with "\*2" cannot be imported or exported.
- Settings marked with "\*3" may be unavailable or vary or have different defaults depending on your country or region.

### <Default Screen After Startup/Restoration>

By default, the Home screen is displayed immediately after the machine is turned ON or when the Auto Reset function is performed. Specify the setting to change the default screen and display the main screen of a different function.

```
<Home> †
<Copy>
<Fax>*1
<Scan>
<Secure Print>
<Status Monitor>
```



<Menu> ▶ <Preferences> ▶ <Display Settings> ▶ <Default Screen After Startup/Restoration> ▶ Select a function to display the desired screen ▶

### <Home Screen Button Display Settings> \*2

Configure the settings for the buttons displayed in the Home screen. You can select the settings that will be displayed as shortcut buttons, rearrange the order in which the buttons appear, and insert or remove spaces. ▶<Customizing the Home Screen>(P. 165)

```
<Select Button to Display>
```

<Favorite Copy Settings>  
 <Favorite Fax Settings>\*1  
 <Favorite Scan Settings>

<Set Display Order>

## <Language> \*3

Select the display language used for the display, reports, and lists.

<Català>  
 <Čeština>  
 <Dansk>  
 <Deutsch>  
 <Eesti>  
 <English> †  
 <Español>  
 <Euskara>  
 <Français>  
 <Hrvatski>  
 <Italiano>  
 <Latviešu>  
 <Lietuvių>  
 <Magyar>  
 <Nederlands>  
 <Norsk>  
 <Polski>  
 <Português>  
 <Română>  
 <Slovenčina>  
 <Slovenščina>  
 <Suomi>  
 <Svenska>  
 <Türkçe>  
 <Ελληνικά>  
 <Български>  
 <Русский>  
 <العربية>  
 <日本語>  
 <中文(繁體)>  
 <中文(简体)>  
 <한국어>



<Menu> ▶ <Preferences> ▶ <Display Settings> ▶ <Language> ▶ Select a language ▶ <Yes> ▶

## <Remote UI Language> \*3

Select the display language used for the Remote UI screens.



- <English> +
- <Japanese>
- <French>
- <Spanish>
- <German>
- <Italian>
- <Dutch>
- <Finnish>
- <Portuguese>
- <Norwegian>
- <Swedish>
- <Danish>
- <Czech>
- <Hungarian>
- <Russian>
- <Turkish>
- <Polish>
- <Chinese (Simplified)>
- <Chinese (Traditional)>
- <Korean>





<Menu> ▶ <Preferences> ▶ <Display Settings> ▶ <Remote UI Language> ▶ Select a language ▶ 

### <Notify to Clean Orig. Scan Area>

Specify whether to display a message when stains are detected in the document feed scanning area.

- <Off>
- <On> +



<Menu> ▶ <Preferences> ▶ <Display Settings> ▶ <Notify to Clean Orig. Scan Area> ▶ Select <Off> or <On> ▶ 

### <Millimeter/Inch Entry Switch>

Select the unit of measurement.

- <Millimeter> +
- <Inch>



<Menu> ▶ <Preferences> ▶ <Display Settings> ▶ <Millimeter/Inch Entry Switch> ▶ Select <Millimeter> or <Inch> ▶

## <Display Timing for Cart. Prep.>

Set the display timing for the message notifying you that the amount remaining in the toner cartridges is low.

<Auto>  
<Off>  
<Custom>  
<On> †



<Menu> ▶ <Preferences> ▶ <Display Settings> ▶ <Display Timing for Cart. Prep.> ▶ Select <Off> in <Auto> ▶ Enter toner level in <Custom> ▶ <Apply> ▶

## <Display Notif. to Clean Fixing Assembly>

Select whether to display a message that prompts you to clean the fixing unit. If you set to <On>, you can specify the timing to display a prompt message for cleaning the fixing unit, in terms of the number of printed pages and in units of 1,000.

<Off> †  
<On>



<Menu> ▶ <Preferences> ▶ <Display Settings> ▶ <Display Notif. to Clean Fixing Assembly> ▶ <On> ▶ Enter the number of printed pages ▶ <Apply> ▶

## <English Keyboard Layout>

---

261J-08C

Specify the layout of a USB keyboard if connected to the machine. The default setting is marked with a dagger (†).

<USA Layout>  
<UK Layout> †



<Menu> ▶ <Preferences> ▶ <English Keyboard Layout> ▶ Select <USA Layout> or <UK Layout>  
▶ 

## <Timer/Energy Settings>

All the settings related to the timer and energy are listed with descriptions. Default settings are marked with a dagger (+).

- ▶<Current Date/Time Settings>(P. 452)
- ▶<Date/Time Settings>(P. 452)
- ▶<Date Format>(P. 453)
- ▶<Time Format>(P. 453)
- ▶<Auto Reset Time>(P. 454)
- ▶<Function After Auto Reset>(P. 454)
- ▶<Auto Shutdown Time>(P. 455)
- ▶<Auto Sleep Time>(P. 455)
- ▶<Auto Sleep Daily Timer>(P. 456)
- ▶<Sleep Mode Exit Time Settings>(P. 456)

### NOTE

#### Asterisks (\*)

- Settings marked with "\*"1" cannot be imported or exported.
- Settings marked with "\*"2" may be unavailable or vary or have different defaults depending on your country or region.

### <Current Date/Time Settings> \*1

Set the current date and time. ▶<Setting the Date/Time>(P. 12)

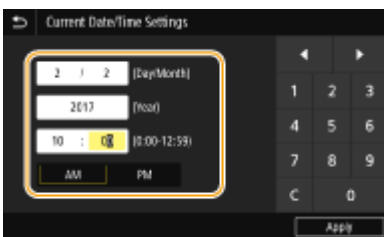

### IMPORTANT

- Set <Time Zone> before setting the current date and time. If the <Time Zone> setting is changed, the current date and time are also changed accordingly.

### NOTE

- The current date and time cannot be changed for 1 hour after daylight saving time goes into effect.

### <Date/Time Settings>

Specify the date and time standard of the region in which the machine is to be installed.

## <Time Zone>

Select the time zone. If the time zone setting is changed, the values set in <Current Date/Time Settings> are also changed accordingly.  **Setting the Date/Time(P. 12)**

<(UTC-12:00) International Date Line West> to <(UTC) Coordinated Universal Time>  to <(UTC+14:00) Kiritimati Island>

## NOTE

### UTC

- Coordinated Universal Time (UTC) is the primary time standard by which the world regulates clocks and time. The correct UTC time zone setting is required for Internet communications.

## <Daylight Saving Time Settings> \*2

Enable or disable daylight saving time. If daylight saving time is enabled, specify the dates from which and to which daylight saving time is in effect.









<Off>

<On> 

Start: Month, Week, Day

End: Month, Week, Day



<Menu>  <Preferences>  <Timer/Energy Settings>  <Date/Time Settings>  <Daylight Saving Time Settings>  Select <On>, and specify the dates  <Apply>  

## <Date Format> \*2







Select the date format (order of year, month, and day).

<YYYY MM/DD>

<MM/DD/YYYY>

<DD/MM YYYY> 



<Menu>  <Preferences>  <Timer/Energy Settings>  <Date Format>  Select the date format  

## <Time Format>

Select the 12- or 24-hour clock display setting.

<12 Hour (AM/PM)> 

&lt;24 Hour&gt;



<Menu> ▶ <Preferences> ▶ <Timer/Energy Settings> ▶ <Time Format> ▶ Select the display setting ▶

## <Auto Reset Time>

If a key is not pressed for a specified period of time, the screen and the settings are initialized to display the default screen (Auto Reset). Specify the interval at which the Auto Reset is performed. The Auto Reset is not performed in the following cases:

- The setting menu is displayed.
- The machine is processing data, such as when printing documents or sending or receiving faxes.
- An error message is displayed and the Error indicator is blinking (However, Auto Reset is performed when the error does not prevent the user from continuing to use a function.)

### <Set This Function>

&lt;Off&gt;

&lt;On&gt; †

&lt;Set Time&gt;

1 to 2 † to 9 (min.)



<Menu> ▶ <Preferences> ▶ <Timer/Energy Settings> ▶ <Auto Reset Time> ▶ Select <On> in <Set This Function> ▶ Enter the time in <Set Time> ▶ <Apply> ▶

## NOTE

- The screen displayed after the Auto Reset is performed can be selected in <Function After Auto Reset>.

## <Function After Auto Reset>

Select whether to return the display to the default screen after the Auto Reset is performed. If <Default Function> is selected, the main screen of the function selected in <Default Screen After Startup/Restoration> is displayed ( **<Default Screen After Startup/Restoration>(P. 447)** ). If <Selected Function> is selected, the display returns to the main screen of the function that was selected.

&lt;Default Function&gt; †

&lt;Selected Function&gt;



<Menu> ▶ <Preferences> ▶ <Timer/Energy Settings> ▶ <Function After Auto Reset> ▶ Select <Default Function> or <Selected Function> ▶

## <Auto Shutdown Time>

Set a timer to automatically shut down the machine after a specified period of idle time has elapsed since the machine entered the sleep mode.

### <Set This Function>

<Off>

<On> †

<Set Time>

1 to 4 † to 8 (hr.)



<Menu> ▶ <Preferences> ▶ <Timer/Energy Settings> ▶ <Auto Shutdown Time> ▶ Select <On>, and set the Auto Shutdown time ▶ <Apply> ▶

## IMPORTANT

### Before setting <Auto Shutdown Time>

- When the <Auto Shutdown Time> setting is enabled, the machine may automatically shut down even if you are operating the machine from the Remote UI or from the Send Function Setting Tool. A malfunction may occur, particularly if the machine shuts down while data is being imported. When you import data using the Remote UI or use the Send Function Setting Tool, set <Auto Shutdown Time> to <Off> in advance.

## NOTE

- If any settings of the [Timer Settings] are changed from the Remote UI while the machine is in the sleep mode, the timer for the <Auto Shutdown Time> setting is reset to the beginning. The machine automatically shuts down after a specified period of idle time has elapsed since the timer was reset.

## <Auto Sleep Time>

If the machine has not been operated or has had no data to process for a specified period of time, the machine enters sleep mode to save energy consumption (Auto Sleep). Specify the period of time after which auto sleep is performed. Auto Sleep is not performed when the setting menu is displayed. We recommend using the factory default settings to save the most power. **Entering Sleep Mode(P. 174)**

1 † to 60 (min.)

## <Auto Sleep Daily Timer>

You can specify the time when the machine is automatically set to the sleep mode. **▶Entering Sleep Mode(P. 174)**

### <Set This Function>

<Off> †

<On>

(0:00 to 12:59 AM/PM)

## <Sleep Mode Exit Time Settings>

Specify the time when the machine is recovered from the sleep mode. **▶Entering Sleep Mode(P. 174)**

### <Set This Function>

<Off> †

<On>

(0:00 to 12:59 AM/PM)



## <Network>

All the settings related to the network are listed with descriptions. Default settings are marked with a dagger (†).

- ▶<Select Wired/Wireless LAN>(P. 457)
- ▶<Wireless LAN Settings>(P. 457)
- ▶<Direct Connection Settings>(P. 458)
- ▶<Easy Connection via PC>(P. 459)
- ▶<TCP/IP Settings>(P. 460)
- ▶<SNMP Settings>(P. 466)
- ▶<Use Dedicated Port>(P. 467)
- ▶<Dedicated Port Auth. Method>(P. 467)
- ▶<Wait Time for Conn. at Startup>(P. 467)
- ▶<Ethernet Driver Settings>(P. 468)
- ▶<Use IEEE 802.1X>(P. 468)
- ▶<Firewall Settings>(P. 468)
- ▶<Google Cloud Print Settings>(P. 470)
- ▶<Device Settings Management>(P. 470)
- ▶<RMT-SW>(P. 470)
- ▶<Initialize Network Settings>(P. 470)

### NOTE

#### Asterisks (\*)

- Settings marked with "\*1" cannot be imported or exported.
- Settings marked with "\*2" may not be displayed depending on the model you are using, options, or other setting items.

### <Select Wired/Wireless LAN>

When switching the machine from Wireless LAN to Wired LAN, you need to specify the setting. Conversely, when switching the machine from Wired LAN to Wireless LAN, you do not need to specify this setting (You can switch using the following <Wireless LAN Settings>). ▶<Selecting Wired LAN or Wireless LAN(P. 16)>

<Wired LAN> † <Wireless LAN>
---------------------------------

### <Wireless LAN Settings>

Specify settings for connecting the machine to a wireless LAN. You can also view the current settings or specify the setting for saving power consumption.

#### <SSID Settings>

Select to configure a wireless connection by specifying information including an SSID or a network key by inputting manually from the operation panel.

#### <Select Access Point>

Wireless LAN routers that can access the machine are automatically located, so you can select from the list. You must manually enter a network key, such as a WEP key or a PSK. ▶<Setting Up Connection by Selecting a Wireless Router(P. 24)>

**<Enter Manually>**

Select to configure a wireless connection by manually entering an SSID. By using this method, you can specify authentication and encryption settings in detail. **▶Setting Up Connection by Specifying Detailed Settings(P. 27)**

```

<Security Settings>
  <None>
  <WEP>
    <Open System> †
      WEP Key 1 to 4
    <Shared Key>
      WEP Key 1 to 4
  <WPA/WPA2-PSK>
    <Auto> †
    <AES-CCMP>
    
```

**<WPS Push Button Mode>**

Select to automatically configure a wireless connection by using the button on a WPS wireless router. **▶Setting Up Connection Using WPS Push Button Mode(P. 20)**

**<WPS PIN Code Mode>**

Select to configure a wireless connection by entering a PIN code for a WPS wireless router. **▶Setting Up Connection Using WPS PIN Code Mode(P. 22)**

**<Power Save Mode>**

Select whether or not the machine enters Power Save Mode based on signals emitted from the wireless router.

```

<Off>
<On> †
    
```



<Menu> ▶ <Preferences> ▶ <Network> ▶ <Wireless LAN Settings> ▶ Read the displayed message ▶ <OK> ▶ <Power Save Mode> ▶ Select <Off> or <On> ▶ 

**<Connection Information> \*1**

Select to view the current wireless LAN settings. **▶Viewing Network Settings(P. 38)**

```

<MAC Address>
<Wireless LAN Status>
<Latest Error Information>
<Channel>
<SSID Settings>
<Security Settings>
<Power Save Mode>
    
```

**<Direct Connection Settings>**

Set whether to connect directly. By enabling this function, connecting directly with the machine is possible even in an environment without an access point or wireless LAN router. **▶Connecting Directly (Access Point Mode)(P. 323)**

**<Use Direct Connection>**

&lt;Off&gt; †

&lt;On&gt;

**<Direct Connection Termination>**

Specify the time to automatically disconnect after Direct Connection is established.

**<Automatically Terminate Session>**

&lt;Off&gt; †

&lt;On&gt;

&lt;Time Until Session Terminates&gt;

1 † to 60 (min.)



<Menu> ▶ <Preferences> ▶ <Network> ▶ <Direct Connection Settings> ▶ <Direct Connection Termination> ▶ Select <On> in <Automatically Terminate Session> and enter the time ▶ <Apply> ▶ <Apply> ▶

**<Access Point Mode Settings>**

Configure the SSID/network key arbitrarily. If you want to connect multiple mobile devices to the machine at the same time, you need to configure both SSID and network key arbitrarily.

**<Use Custom SSID>**

&lt;Off&gt; †

&lt;On&gt;

&lt;SSID&gt;

**<Use Custom Network Key>**

&lt;Off&gt; †

&lt;On&gt;

&lt;Network Key&gt;



<Menu> ▶ <Preferences> ▶ <Network> ▶ <Direct Connection Settings> ▶ <Access Point Mode Settings> ▶ Select <On> for each item and select <SSID>/<Network Key> ▶ Enter the SSID/network key ▶ <Apply> ▶ <Apply> ▶ <Apply> ▶

**<Easy Connection via PC>**

Start the procedure for Easy Connection via PC (cableless setup mode). You can use Canon Laser NW Device Setup Utility to configure network settings via a computer.



<Menu> ▶ <Preferences> ▶ <Network> ▶ <Easy Connection via PC> ▶ <Yes> ▶ The connection process starts

## NOTE

- Download Canon Laser NW Device Setup Utility from the Canon website (<http://www.canon.com/>).

## <TCP/IP Settings>

Specify settings for using the machine in a TCP/IP network, such as IP address settings.

### <IPv4 Settings>

Specify settings for using the machine in an IPv4 network.

### <IP Address Settings>

Configure the IP address, which is used for identifying devices, such as computers and printers, on a TCP/IP network. ▶ **Setting IPv4 Address(P. 32)**

```

<Auto Acquire>
  <Auto Acquire>
    <Off>
    <On> †
      <Select Protocol>
        <Off>
        <DHCP> †
      <Auto IP>
        <Off>
        <On> †

<Manually Acquire> *2
  <IP Address>: 0.0.0.0
  <Subnet Mask>: 0.0.0.0
  <Gateway Address>: 0.0.0.0

<Check Settings>
  
```

### <DHCP Option Settings>

If DHCP is enabled, use these settings to select whether to use the DHCP optional functions to acquire the DNS server address or the domain name. ▶ **Configuring DNS(P. 56)**

```

<Acquire Host Name>
  <Off>
  <On> †

<DNS Dynamic Update>
  <Off> †
  <On>
  
```

**<Acquire DNS Server Address>**

&lt;Off&gt;

&lt;On&gt; †

**<Acquire Domain Name>**

&lt;Off&gt;

&lt;On&gt; †

**<Acquire WINS Server Address>**

&lt;Off&gt;

&lt;On&gt; †

**<Acquire SMTP Server Address>**

&lt;Off&gt; †

&lt;On&gt;

**<Acquire POP Server Address>**

&lt;Off&gt; †

&lt;On&gt;

**<PING Command>**

Select to check that the machine is connected to a computer over a network. [▶Testing the Network Connection\(P. 33\)](#)

**<IPv6 Settings>**

Specify settings for using the machine in an IPv6 network. [▶Setting IPv6 Addresses\(P. 35\)](#)

**<Use IPv6>**

&lt;Off&gt; †

&lt;On&gt;

**<Check IPv6 Settings>**

You can check the link-local address that is automatically acquired.

**<Stateless Address Settings>**

Enable or disable stateless addresses.

**<Stateless Address Settings>**

&lt;Off&gt;

&lt;On&gt; †

**<Check Settings>**

&lt;Stateless Address&gt;

&lt;Prefix Length&gt;

**<DHCPv6 Settings>**

Enable or disable the stateful address that is acquired via DHCPv6.

**<Use DHCPv6>**

&lt;Off&gt; †

&lt;On&gt;

**<Check Settings>**

<Stateful Address>  
<Prefix Length>

### <DHCP Option Settings>

If DHCP is enabled, use these settings to select whether to use the DHCP optional functions to acquire the DNS server address or the domain name. [▶Configuring DNS\(P. 56\)](#)

<Acquire DNS Server Address>  
<Off>  
<On> †

<Acquire Domain Name>  
<Off>  
<On> †

### <DNS Settings>

Specify settings for Domain Name System (DNS), which provides a host name for IP address resolutions. [▶Configuring DNS\(P. 56\)](#)

#### <IPv4 DNS Server Address Settings>

Specify the IP address of the DNS server in the IPv4 environment.

<Primary DNS Server>: 0.0.0.0  
<Secondary DNS Server>: 0.0.0.0

#### <DNS Host Name/Domain Name Settings>

Specify the host name of the machine to be registered in the DNS server as well as the name of the domain to which the machine belongs.

<IPv4>  
<Host Name>  
<Domain Name>

<IPv6>  
<Use IPv4 Host/Domain>  
<Off>  
<Host Name>  
<Domain Name>  
<On> †

#### <DNS Dynamic Update Settings>

Select whether to dynamically update the DNS records whenever the machine's IP address is changed.

<IPv4>  
<DNS Dynamic Update>  
<Off> †  
<On>  
<DNS Dynamic Update Interval>  
0 to 24 † to 48 (hr.)

<IPv6>  
<DNS Dynamic Update>  
<Off> †

```

<On>
  <Register Manual Address>
    <Off> †
    <On>
  <Register Stateful Address>
    <Off> †
    <On>
  <Register Stateless Address>
    <Off> †
    <On>
  <DNS Dynamic Update Interval>
    0 to 24 † to 48 (hr.)

```

### <mDNS Settings>

Specify settings for using DNS functions without DNS servers.

```

<IPv4>
  <Use mDNS>
    <Off>
    <On> †
    <mDNS Name>

<IPv6>
  <Use mDNS>
    <Off>
    <On> †
    <Use Same mDNS Name as IPv4>
      <Off>
      <mDNS Name>
    <On> †

```

### <WINS Settings>

Specify settings for Windows Internet Name Service (WINS), which provides a NetBIOS name for IP address resolutions in a mixed network environment of NetBIOS and TCP/IP. [▶ Configuring WINS\(P. 62\)](#)

```

<WINS Resolution>
  <Off> †
  <On>
  <WINS Server Address>: 0.0.0.0

```

### <LPD Settings>

Enable or disable LPD, a printing protocol that can be used on any hardware platform or operating system. You can also set the reception timeout period after which printing is canceled if print data reception is interrupted.

[▶ Configuring Printing Protocols and WSD Functions\(P. 41\)](#)

```

<Use LPD Printing>
  <Off>
  <On> †

<RX Timeout>
  1 to 5 † to 60 (min.)

```

**<RAW Settings>**

Enable or disable RAW, a Windows specific printing protocol. You can also set the reception timeout period after which printing is canceled if print data reception is interrupted. **▶Configuring Printing Protocols and WSD Functions(P. 41)**

**<Use RAW Printing>**

&lt;Off&gt;

&lt;On&gt; †

**<RX Timeout>**

1 to 5 † to 60 (min.)

**<WSD Settings>**

Enable or disable automatic browsing and acquiring information for the printer or scanner by using the WSD protocol. **▶Configuring Printing Protocols and WSD Functions(P. 41)**

**<Use WSD Printing>**

&lt;Off&gt;

&lt;On&gt; †

**<Use WSD Browsing>**

&lt;Off&gt;

&lt;On&gt; †

**<Use WSD Scanning>**

&lt;Off&gt; †

&lt;On&gt;

**<Use Computer Scanning>**

&lt;Off&gt; †

&lt;On&gt;

**<Use Multicast Discovery>**

&lt;Off&gt;

&lt;On&gt; †

**<Use FTP PASV Mode>**

Specify whether to use PASV mode for FTP. If you are connecting to an FTP server through a firewall, you must select PASV mode. **▶Configuring FTP PASV Mode(P. 73)**

&lt;Off&gt; †

&lt;On&gt;

**<Use HTTP>**

Enable or disable HTTP, which is required for communications with a computer, such as when using the Remote UI, WSD printing, or printing with Google Cloud Print. **▶Disabling HTTP Communication(P. 410)**

&lt;Off&gt;

&lt;On&gt; †



**<Use IPSec> \*1**

Select whether to perform encrypted communication by establishing a virtual private network (VPN) via IPSec.

**▶Configuring IPSec Settings(P. 387)**

<Off> †  
<On>



<Menu> ▶ <Preferences> ▶ <Network> ▶ <TCP/IP Settings> ▶ <Use IPSec> ▶ Select <Off> or <On> ▶ <OK> ▶ Restart the machine

**<Port Number Settings>**

Change port numbers for protocols according to the network environment. ▶**Changing Port Numbers(P. 372)**

**<LPD>**  
1 to 515 † to 65535

**<RAW>**  
1 to 9100 † to 65535

**<WSD Multicast Discovery>**  
1 to 3702 † to 65535

**<HTTP>**  
1 to 80 † to 65535

**<Multicast Discovery>**  
1 to 427 † to 65535

**<POP3>**  
1 to 110 † to 65535

**<SMTP>**  
1 to 25 † to 65535

**<FTP>**  
1 to 21 † to 65535

**<SNMP>**  
1 to 161 † to 65535

**<MTU Size>**

Select the maximum size of packets the machine sends or receives. ▶**Changing the Maximum Transmission Unit(P. 54)**

<1300>  
<1400>  
<1500> †

## <SNMP Settings>

Specify the settings for monitoring and controlling the machine from a computer running SNMP-compatible software.  
**Monitoring and Controlling the Machine with SNMP(P. 69)**

### <SNMPv1 Settings>

Enable or disable SNMPv1. When enabling SNMPv1, specify a community name and access privileges to Management Information Base (MIB) objects.

<Off>  
 <On> +



<Menu> ▶ <Preferences> ▶ <Network> ▶ <SNMP Settings> ▶ Select <Off> or <On> in <SNMPv1 Settings> ▶ <Apply> ▶ <OK> ▶ Restart the machine

### <SNMPv3 Settings>

Enable or disable SNMPv3. Use the Remote UI to specify detailed settings that are applied when SNMPv3 is enabled.

<Off> +  
 <On>



<Menu> ▶ <Preferences> ▶ <Network> ▶ <SNMP Settings> ▶ Select <Off> or <On> in <SNMPv3 Settings> ▶ <Apply> ▶ <OK> ▶ Restart the machine

### <Acquire Printer Mngt. Info. from Host>

Enable or disable the monitoring of printer management information from a networked computer running SNMP-compatible software.

<Off> +  
 <On>



<Menu> ▶ <Preferences> ▶ <Network> ▶ <SNMP Settings> ▶ Select <Off> or <On> in <Acquire Printer Mngt. Info. from Host> ▶ <Apply> ▶ <OK> ▶ Restart the machine

### <Format Host Rsrcs. MIB to RFC2790>

Specify whether to conform to the advanced specifications (RFC2790) of the protocol when monitoring the machine status from the SNMP-compatible software.

<Off>  
 <On> +



<Menu> ▶ <Preferences> ▶ <Network> ▶ <SNMP Settings> ▶ Select <Off> or <On> in <Format Host Rsrcs. MIB to RFC2790> ▶ <Apply> ▶ <OK> ▶ Restart the machine

## <Use Dedicated Port>

Enable or disable the dedicated port. The dedicated port is used when printing, faxing, or scanning uses MF Scan Utility and when browsing or specifying the machine settings over the network.

<Off>  
<On> +



<Menu> ▶ <Preferences> ▶ <Network> ▶ <Use Dedicated Port> ▶ Select <Off> or <On> ▶ <OK> ▶ Restart the machine

## <Dedicated Port Auth. Method>

Specify whether to limit the authentication method specifically to the secure one when using the dedicated port. If <Mode 2> is selected, the authentication method is limited specifically to the secure one.

<Mode 1> +  
<Mode 2>



<Menu> ▶ <Preferences> ▶ <Network> ▶ <Dedicated Port Auth. Method> ▶ Select <Mode 1> or <Mode 2> ▶

## IMPORTANT

- If <Mode 2> is selected, you cannot establish a connection from the device management software or driver in some cases.

## <Wait Time for Conn. at Startup>

Specify a wait time for connecting to a network. Select the setting depending on the network environment. **Setting a Wait Time for Connecting to a Network(P. 55)**

0 + to 300 (sec.)

## <Ethernet Driver Settings>

Select the Ethernet type (10BASE-T/100BASE-TX/1000BASE-T) and the communication mode of Ethernet (half-duplex/full-duplex). You can also view the MAC address for wired LAN.

### <Auto Detect>

Select whether to automatically detect or manually select the communication mode and the Ethernet type. ▶ **Configuring Ethernet Settings(P. 52)**

<Off>  
 <Communication Mode>  
 <Half Duplex> †  
 <Full Duplex>  
 <Ethernet Type>  
 <10BASE-T> †  
 <100BASE-TX>  
 <1000BASE-T>  
 <On> †

## NOTE

- When <Communication Mode> is set to <Half Duplex>, you cannot select <1000BASE-T>.

### <MAC Address>

Check the MAC address of the machine, which is a number unique to each communication device. ▶ **Viewing the MAC Address for Wired LAN(P. 38)**

## <Use IEEE 802.1X> \*1\*2

Enable or disable IEEE 802.1X authentication. ▶ **Configuring IEEE 802.1X Authentication Settings(P. 394)**

<Off> †  
 <On>



<Menu> ▶ <Preferences> ▶ <Network> ▶ <Use IEEE 802.1X> ▶ Select <Off> or <On> ▶  
 <OK> ▶ Restart the machine

## <Firewall Settings>

Without proper security, unauthorized third parties can access computers and other communication devices that are connected to a network. To prevent this unauthorized access, specify the settings for packet filter, a feature that restricts communication to devices with specified IP addresses or MAC addresses.

**<IPv4 Address Filter>**

Enable or disable settings for filtering packets sent to or received from devices with specified IPv4 addresses. ▶  
**Specifying IP Addresses for Firewall Settings(P. 366)**

**<Outbound Filter>**

&lt;Off&gt; †

&lt;On&gt;

**<Inbound Filter>**

&lt;Off&gt; †

&lt;On&gt;



<Menu> ▶ <Preferences> ▶ <Network> ▶ <Firewall Settings> ▶ <IPv4 Address Filter> ▶ Select  
 <Off> or <On> in <Outbound Filter> or <Inbound Filter> ▶ <Apply> ▶ <OK> ▶ Restart the machine

**<IPv6 Address Filter>**

Enable or disable settings for filtering packets sent to or received from devices with specified IPv6 addresses. ▶  
**Specifying IP Addresses for Firewall Settings(P. 366)**

**<Outbound Filter>**

&lt;Off&gt; †

&lt;On&gt;

**<Inbound Filter>**

&lt;Off&gt; †

&lt;On&gt;



<Menu> ▶ <Preferences> ▶ <Network> ▶ <Firewall Settings> ▶ <IPv6 Address Filter> ▶ Select  
 <Off> or <On> in <Outbound Filter> or <Inbound Filter> ▶ <Apply> ▶ <OK> ▶ Restart the machine

**<MAC Address Filter>**

Enable or disable settings for filtering packets sent to or received from devices with specified MAC addresses. ▶  
**Specifying MAC Addresses for Firewall Settings(P. 369)**

**<Outbound Filter>**

&lt;Off&gt; †

&lt;On&gt;

**<Inbound Filter>**

&lt;Off&gt; †

&lt;On&gt;



<Menu> ▶ <Preferences> ▶ <Network> ▶ <Firewall Settings> ▶ <MAC Address Filter> ▶ Select <Off> or <On> in <Outbound Filter> or <Inbound Filter> ▶ <Apply> ▶ <OK> ▶ Restart the machine

## <Google Cloud Print Settings>

Enable or disable Google Cloud Print. ▶ **Registering the Machine with Google Cloud Print(P. 341)**

<Use Google Cloud Print>  
 <Off>  
 <On> +

<Google Cloud Print Regist. Status> \*1

## <Device Settings Management>

Specify whether to use iW Management Console plug-ins to manage machine data such as settings and Address Book destinations. For detailed information on iW Management Console, contact your nearest Canon dealer. ▶ **Configuring Settings for Communication between the Machine and Plug-ins(P. 76)**

<Off>  
 <On> +

## <RMT-SW>

Leave this switch set to <Off>. When the service representative remotely performs device maintenance, you may be asked to set the switch to <On>.

<Off> +  
 <On>



<Menu> ▶ <Preferences> ▶ <Network> ▶ <RMT-SW> ▶ Select <Off> or <On> ▶ <OK> ▶ Restart the machine

## <Initialize Network Settings>

Select to return the Network Settings to the factory defaults. ▶ **<Initialize Menu>(P. 553)**

## <External Interface>

---

All the settings related to the USB are listed with descriptions. Default settings are marked with a dagger ( †).

### <USB Settings>

Specify whether to enable or disable use of the USB port or a USB memory device.

#### <Use as USB Device>

---

Enable or disable the USB port that is used for connecting the machine to a computer.  **Restricting the USB Connection with a Computer(P. 408)**

<Off>  
<On> †

#### <Use USB Storage Device>

---

Specify whether to use a USB memory device.

<Off>  
<On> †



<Menu> ▶ <Preferences> ▶ <External Interface> ▶ <USB Settings> ▶ Select <Off> or <On> in <Use USB Storage Device> ▶ <Apply> ▶ <OK> ▶ Restart the machine

## <Accessibility>

261J-08J

All the settings related to accessibility, such as inverting the screen colors and message display time, are listed with descriptions. Default settings are marked with a dagger ( †).

▶<Invert Screen Colors>(P. 472)

▶<Brightness>(P. 472)

▶<Message Display Time>(P. 472)

### <Invert Screen Colors>

Select <On> to invert the display colors. Select <On> if the display is hard to view even after the brightness was adjusted in <Brightness>.

<Off> †  
<On>



<Menu> ▶ <Preferences> ▶ <Accessibility> ▶ <Invert Screen Colors> ▶ Select <Off> or <On> ▶

### <Brightness>

Adjust the brightness of the display to suit the installation location of the machine.

Five Levels



<Menu> ▶ <Preferences> ▶ <Accessibility> ▶ <Brightness> ▶ Adjust the brightness ▶ <Apply> ▶

### <Message Display Time>

Specify the interval in seconds at which two different messages are alternately displayed.

1 to 2 † to 5 (sec.)



<Menu> ▶ <Preferences> ▶ <Accessibility> ▶ <Message Display Time> ▶ Enter a number for the interval ▶ <Apply> ▶



## <Adjustment/Maintenance>

---

261J-08K

Item	Description
▶<Adjust Image Quality>(P. 474)	This section describes how to adjust image quality for printing.
▶<Maintenance>(P. 482)	This section describes how to use the cleaning functions.

## <Adjust Image Quality>

261J-08L

All the settings related to image quality adjustment are listed with descriptions. Default settings are marked with a dagger (†).

- ▶<Adjust Copy Image>(P. 474)
- ▶<Printer Density>(P. 474)
- ▶<Toner Save>(P. 474)
- ▶<Black Text Processing for Color>(P. 475)
- ▶<Adjust Print Position>(P. 475)
- ▶<Special Processing>(P. 476)
- ▶<Remove Streaks from Scan Area>(P. 481)

### NOTE

#### Asterisks (\*)

- Settings marked with an asterisk (\*) may not be displayed depending on the model you are using, options, or other setting items.

### <Adjust Copy Image>

Adjust the gradation and density in copies. ▶<Adjusting the Gradation and Density for Copy Jobs>(P. 573)

### <Printer Density>

Adjust this if the printed text or thin lines are faded. ▶<Adjusting Print Density>(P. 577)

Nine Levels

### <Toner Save>

You can save toner when performing: copying, printing of received faxes, or report printing.

<Off> †  
<On>



<Menu> ▶ <Adjustment/Maintenance> ▶ <Adjust Image Quality> ▶ <Toner Save> ▶ Select <Off> or <On> ▶

## <Black Text Processing for Color>

Select whether the color of black or blackish text in color documents should be reproduced as true black or as a color more or less close to that of the original. For each option, you can adjust the degree of effect. You can set values for the feeder and the platen glass separately. **▶Adjusting Values for Text Color Reproducibility(P. 575)**

### <Feeder>

Seven Levels

### <Platen Glass>

Seven Levels

## <Adjust Print Position>

Adjust the print position for each paper source. The print position can be adjusted in the range from -5.0 mm to +5.0 mm in increments of 0.1 mm. **▶Adjusting Print Position(P. 578)**

### <Multi-Purpose Tray>

<Adjust Vertically (Front Side)>

-5.0 to 0.0 **↑** to + 5.0 (mm)

<Adjust Horizontally (Front Side)>

-5.0 to 0.0 **↑** to + 5.0 (mm)

<Adjust Vertically (Back Side)>

-5.0 to 0.0 **↑** to + 5.0 (mm)

<Adjust Horizontally (Back Side)>

-5.0 to 0.0 **↑** to + 5.0 (mm)

### <Drawer 1>

<Adjust Vertically (Front Side)>

-5.0 to 0.0 **↑** to + 5.0 (mm)

<Adjust Horizontally (Front Side)>

-5.0 to 0.0 **↑** to + 5.0 (mm)

<Adjust Vertically (Back Side)>

-5.0 to 0.0 **↑** to + 5.0 (mm)

<Adjust Horizontally (Back Side)>

-5.0 to 0.0 **↑** to + 5.0 (mm)

### <Drawer 2> \*

<Adjust Vertically (Front Side)>

-5.0 to 0.0 **↑** to + 5.0 (mm)

<Adjust Horizontally (Front Side)>

-5.0 to 0.0 **↑** to + 5.0 (mm)

<Adjust Vertically (Back Side)>

-5.0 to 0.0 **↑** to + 5.0 (mm)

<Adjust Horizontally (Back Side)>

-5.0 to 0.0 **↑** to + 5.0 (mm)

### <Drawer 3> \*

<Adjust Vertically (Front Side)>  
 -5.0 to 0.0 **↑** to + 5.0 (mm)  
 <Adjust Horizontally (Front Side)>  
 -5.0 to 0.0 **↑** to + 5.0 (mm)  
 <Adjust Vertically (Back Side)>  
 -5.0 to 0.0 **↑** to + 5.0 (mm)  
 <Adjust Horizontally (Back Side)>  
 -5.0 to 0.0 **↑** to + 5.0 (mm)

**<Drawer 4> \***

<Adjust Vertically (Front Side)>  
 -5.0 to 0.0 **↑** to + 5.0 (mm)  
 <Adjust Horizontally (Front Side)>  
 -5.0 to 0.0 **↑** to + 5.0 (mm)  
 <Adjust Vertically (Back Side)>  
 -5.0 to 0.0 **↑** to + 5.0 (mm)  
 <Adjust Horizontally (Back Side)>  
 -5.0 to 0.0 **↑** to + 5.0 (mm)

**<Special Processing>**

If the print results on special types of paper are not satisfactory, the following settings may improve the quality of the printouts.

**<Special Paper Processing>**

When printing on the back side of printed paper, rough paper, or envelopes, the print results may be improved by adjusting the following settings.

**<Manual Back Side Print (2-Sided Only)>**

If printouts on the back side of printed paper are too light, select <On>. You can specify this setting separately for each paper source.

**<Multi-Purpose Tray>**

<Off> **↑**  
 <On>

**<Drawer 1>**

<Off> **↑**  
 <On>

**<Drawer 2> \***

<Off> **↑**  
 <On>

**<Drawer 3> \***

<Off> **↑**  
 <On>

**<Drawer 4> \***

<Off> **↑**

<On>



<Menu> ▶ <Adjustment/Maintenance> ▶ <Adjust Image Quality> ▶ <Special Processing> ▶ <Special Paper Processing> ▶ <Manual Back Side Print (2-Sided Only)> ▶ Select <On> in the paper source to be set ▶ <Apply> ▶ <Yes> ▶ 

**NOTE:**

- If you set to <On>, image quality may be affected when a certain length of time elapses after printing on the front side or depending on the ambient humidity.

**<Rough Surface Envelope Mode>**

When printing on envelopes with rough surfaces, select <On>.

<Off>   
 <On>



<Menu> ▶ <Adjustment/Maintenance> ▶ <Adjust Image Quality> ▶ <Special Processing> ▶ <Special Paper Processing> ▶ <Rough Surface Envelope Mode> ▶ <On> ▶ <Yes> ▶ 

**NOTE:**

**If you set <Rough Surface Envelope Mode> to <On>**

- The <Paper Curl Correction> setting will be disabled.
- The printing speed may be slower.

**<Paper Wrinkle Correction>**

Printouts may wrinkle depending on the paper to use. In this case, setting this item to <On> may solve the problem.

<Off>   
 <On>



<Menu> ▶ <Adjustment/Maintenance> ▶ <Adjust Image Quality> ▶ <Special Processing> ▶ <Special Paper Processing> ▶ <Paper Wrinkle Correction> ▶ <On> ▶ <Yes> ▶ 

**NOTE:**



- If you set to <On>, the print may be faded or the printing speed may be slower.

**<Paper Curl Correction>**

If the printed paper curls, set this item to <On>.

<Off> 

<On>

 <Menu> ▶ <Adjustment/Maintenance> ▶ <Adjust Image Quality> ▶ <Special Processing> ▶ <Special Paper Processing> ▶ <Paper Curl Correction> ▶ <On> ▶ <Yes> ▶ 



**NOTE:**

- If you set to <On>, the printing speed may be slower.

**<Reduce Ppr. Sticking at Output>**

When performing 2-sided printing, paper may stick together at the output. Setting to <On> will slow down the printing speed to reduce sticking.



<Off>   
 <On>

 <Menu> ▶ <Adjustment/Maintenance> ▶ <Adjust Image Quality> ▶ <Special Processing> ▶ <Reduce Ppr. Sticking at Output> ▶ <On> ▶ <Yes> ▶ 

**<High Humidity Mode>**

Print density may be uneven when the machine is used in an environment with high humidity. In this case, setting this item to <On> may solve the problem.

<Off>   
 <On>

 <Menu> ▶ <Adjustment/Maintenance> ▶ <Adjust Image Quality> ▶ <Special Processing> ▶ <High Humidity Mode> ▶ <On> ▶ <Yes> ▶ 



**NOTE**

- If you set to <On>, the print density may vary depending on the ambient humidity.

**<Low Humidity Mode>**

When using the machine in an environment with low humidity, printed images and text may be blurry. In this case, set this item. The improvement effect is stronger with <Mode 2> than with <Mode 1>. First try the adjustment with <Mode 1>.

<Off>   
 <Mode 1>  
 <Mode 2>

 <Menu> ▶ <Adjustment/Maintenance> ▶ <Adjust Image Quality> ▶ <Special Processing> ▶ <Low Humidity Mode> ▶ Select the mode ▶ <Yes> ▶ 



**NOTE**

- If <Low Humidity Mode> is specified, print density may be lower or uneven when the machine is used in an environment with high humidity.

**<Reduce Ghosting 1>**

When you print on large size paper after printing on small size paper, afterimages may appear in blank areas. In this case, setting this item to <On> may solve the problem.

<Off> +  
<On>

 <Menu> ▶ <Adjustment/Maintenance> ▶ <Adjust Image Quality> ▶ <Special Processing> ▶ <Reduce Ghosting 1> ▶ <On> ▶ <Yes> ▶ 



**NOTE**

- If you set to <On>, the printing speed may be slower.

**<Rdc Condens. (Consec 2-Sd Prt)>**

If the printed images are faint due to moisture condensation when performing 2-sided printing, setting to other than <Off> may solve the problem.

<Off> +  
<On>

 <Menu> ▶ <Adjustment/Maintenance> ▶ <Adjust Image Quality> ▶ <Special Processing> ▶ <Rdc Condens. (Consec 2-Sd Prt)> ▶ <On> ▶ <Yes> ▶ 

**NOTE**

- If you set to <On>, the printing speed will be slower.

**<Rdc. Wrinkles(Humidity)/Streaks>**

If printouts have creases when damp paper is used or if streaks appear in the leading edge of paper when images with halftones such as photos are printed, setting to <On> may solve the problem.

<Off> +  
<On>



<Menu> ▶ <Adjustment/Maintenance> ▶ <Adjust Image Quality> ▶ <Special Processing> ▶ <Rdc. Wrinkles(Humidity)/Streaks> ▶ <On> ▶ <Yes> ▶

## NOTE

- If you set to <On>, the printing speed will be slower.

### <Quiet Mode>

When printing sounds bother you, set this item to <On>.

<Off> +  
<On>



<Menu> ▶ <Adjustment/Maintenance> ▶ <Adjust Image Quality> ▶ <Special Processing> ▶ <Quiet Mode> ▶ <On> ▶ <Yes> ▶

## NOTE

- If you set to <On>, the printing speed will be slower.

### <Correct Blurry Image>

Streaks may appear on printouts depending on the paper type or the environmental conditions. In this case, setting this item may solve the problem. The improvement effect is weakest with <Mode 1> and strongest with <Mode 4>.

<Off>  
<Mode 1> +  
<Mode 2>  
<Mode 3>  
<Mode 4>



<Menu> ▶ <Adjustment/Maintenance> ▶ <Adjust Image Quality> ▶ <Special Processing> ▶ <Correct Blurry Image> ▶ Select the mode ▶ <Yes> ▶

## NOTE



- Setting a stronger improvement effect may result in lighter print density or slower printing speed. It may also result in less sharp edges and rougher details.

### <Correct Blurry Image for Copy>

Smudges may appear on copies depending on the paper type or the environmental conditions. In this case, setting this item may solve the problem. The improvement effect is strongest with <Mode 3> and weakest with <Mode 1>.

<Off>  
 <Mode 1> †  
 <Mode 2>  
 <Mode 3>



<Menu> ▶ <Adjustment/Maintenance> ▶ <Adjust Image Quality> ▶ <Special Processing> ▶ <Correct Blurry Image for Copy> ▶ Select the mode ▶ <Yes> ▶

## NOTE

- Setting a stronger improvement effect may result in lighter print density.

### <Remove Streaks from Scan Area>

You can configure a setting to prevent stains from being scanned when they are detected in the document feed scanning area. Selecting <On> removes streaks generated by the edge of the original.

<Off>  
 <On> †



<Menu> ▶ <Adjustment/Maintenance> ▶ <Adjust Image Quality> ▶ <Remove Streaks from Scan Area> ▶ Select <Off> or <On> ▶

## NOTE

- When streaks are removed, areas with stains are not scanned. Clean the original scanning area so that the original is scanned satisfactorily.

## <Maintenance>

The cleaning functions are listed with descriptions. Default settings are marked with a dagger ( †).

- ▶<Clean Fixing Assembly>(P. 482)
- ▶<Clean Feeder>(P. 482)
- ▶<Control Condensation>(P. 482)

### <Clean Fixing Assembly>

Clean the fixing assembly after a toner cartridge is replaced or if black streaks appear on printouts. ▶<Cleaning the Fixing Assembly>(P. 565)

### <Clean Feeder>

Clean the feeder rollers if originals become dirty after being fed through the feeder. ▶<Cleaning the Feeder>(P. 562)

### <Control Condensation>

When the temperature changes rapidly in the environment where the machine is installed, condensation occurs, which may cause fading or bleeding in images and text. Select <On> to remove dew condensation in the machine. When selecting <On>, specify whether to restrict jobs.

<Off> †

<On>

<Use Fax Memory Lock> † / <Allow Job Printing During Process> †

<Use Fax Memory Lock + Do Not Allow Job Printing During Process> / <Do Not Allow Job Printing During Process>



<Menu> ▶ <Adjustment/Maintenance> ▶ <Maintenance> ▶ <Control Condensation> ▶ <On> ▶  
Check the message ▶ <OK> ▶ Select the item ▶ <Yes> ▶

## IMPORTANT

- While condensation removal is being performed, printing may not be performed properly and blank paper may be output.
- If you set to <On>, you need to keep the machine turned ON to maintain the effect of condensation removal.

## NOTE

- The setting for <Auto Shutdown Time> is unavailable when <Control Condensation> is set to <On>.

## <Function Settings>

---

261J-08S

Item	Description
▶<Common>(P. 484)	This section describes settings common to each function.
▶<Copy>(P. 490)	This section describes how to specify the copy settings.
▶<Printer>(P. 492)	This section describes how to specify printer settings.
▶<Send>(P. 517)	This section describes how to specify settings for sending faxes and scanned originals.
▶<Receive/Forward>(P. 529)	This section describes how to specify settings for receiving faxes and e-mails.
▶<Store/Access Files>(P. 536)	This section describes the settings for scanning originals and printing stored files.
▶<Secure Print>(P. 542)	This section describes the settings for the Secure Print.

## <Common>

All the items related to settings common to each function are listed with descriptions. Default settings are marked with a dagger ( † ).

▶<Paper Feed Settings>(P. 484)

▶<Scan Settings>(P. 487)

▶<Generate File>(P. 488)

▶<Fax Setup Guide>(P. 489)

## NOTE

### Asterisks (\*)

- Settings marked with "\*1" may not be displayed depending on the model you are using, options, or other setting items.
- Settings marked with "\*2" cannot be imported or exported.

## <Paper Feed Settings>

Configure paper feed settings.

### <Paper Source Auto Selection>

Enable or disable the automatic drawer selection feature for the paper sources. If automatic drawer selection is set to <On> when printing documents, the machine automatically selects a paper source that is loaded with the appropriate paper size. Also, when the paper runs out, this setting enables continuous printing by switching from one paper source to another that is loaded with the same paper size. ▶<Automatically Selecting an Appropriate Paper Source for Each Function>(P. 163)

```

<Copy>
  <Multi-Purpose Tray>
    <Off> †
    <On>
  <Drawer 1>
    <Off>
    <On> †
  <Drawer 2>*1
    <Off>
    <On> †
  <Drawer 3>*1
    <Off>
    <On> †
  <Drawer 4>*1
    <Off>
    <On> †

<Printer>
  <Multi-Purpose Tray>
    <Off>

```

<On> †  
 <Drawer 1>  
 <Off>  
 <On> †  
 <Drawer 2>\*1  
 <Off>  
 <On> †  
 <Drawer 3>\*1  
 <Off>  
 <On> †  
 <Drawer 4>\*1  
 <Off>  
 <On> †

**<Receive/Fax >/<Receive>**

<Multi-Purpose Tray>  
 <Off> †  
 <On>  
 <Drawer 1>  
 <Off>  
 <On> †  
 <Drawer 2>\*1  
 <Off>  
 <On> †  
 <Drawer 3>\*1  
 <Off>  
 <On> †  
 <Drawer 4>\*1  
 <Off>  
 <On> †

**<Other>**

<Multi-Purpose Tray>  
 <Off> †  
 <On>  
 <Drawer 1>  
 <Off>  
 <On> †  
 <Drawer 2>\*1  
 <Off>  
 <On> †  
 <Drawer 3>\*1  
 <Off>  
 <On> †  
 <Drawer 4>\*1  
 <Off>  
 <On> †

## <Switch Paper Feed Method>

Specify this setting when you print a document on paper with logos. In general use, to print on paper with logos, you need to change how the paper loaded in the paper source is facing depending on whether you are performing 1- or 2-sided printing. However, if you change the setting to <Print Side Priority>, you can just load the paper with the logo side facing down for 1-sided printing in the same way as for 2-sided printing. For more information, see **Loading Preprinted Paper(P. 150)** .

<p><b>&lt;Multi-Purpose Tray&gt;</b>                  &lt;Speed Priority&gt; †                  &lt;Print Side Priority&gt;</p>
<p><b>&lt;Drawer 1&gt;</b>                  &lt;Speed Priority&gt; †                  &lt;Print Side Priority&gt;</p>
<p><b>&lt;Drawer 2&gt; *1</b>                  &lt;Speed Priority&gt; †                  &lt;Print Side Priority&gt;</p>
<p><b>&lt;Drawer 3&gt; *1</b>                  &lt;Speed Priority&gt; †                  &lt;Print Side Priority&gt;</p>
<p><b>&lt;Drawer 4&gt; *1</b>                  &lt;Speed Priority&gt; †                  &lt;Print Side Priority&gt;</p>

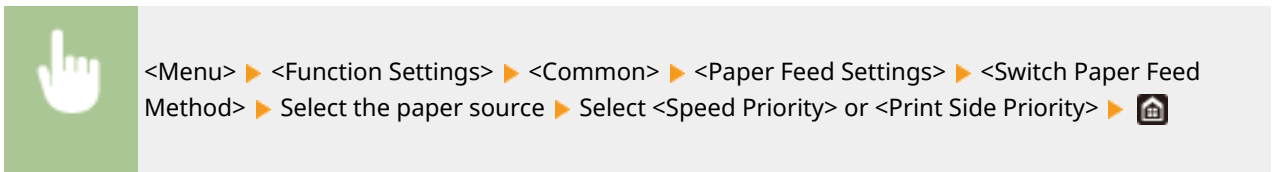

### a Paper Sources

Select the paper source that you want to change the setting for.

### b <Speed Priority>

When using paper that has been preprinted with a logo, you need to change how it is facing when you perform 1-sided and 2-sided printing.

### NOTE:

- We recommend selecting <Speed Priority> if you do not need to consider which side to print on.

### **C** <Print Side Priority>

To print on a specific side of paper, you do not need to flip over paper in the paper source whether 1- or 2-sided printing is selected.

#### **NOTE:**

- If <Print Side Priority> is set for a paper source that is loaded with paper you cannot use for 2-sided printing ( **▶Available Paper(P. 673)** ), <Speed Priority> is applied to the paper source instead. In this case, you need to load the paper in the same way as when <Speed Priority> is selected ( **▶Loading Preprinted Paper(P. 150)** ).
- 1-sided printing speed may be slower when <Print Side Priority> is selected.

## <Scan Settings>

Configure scan settings.

### <Auto Online>

When scanning from the computer, use this to specify whether to automatically go online for remote scanning (scan standby mode) without using the operation panel.

<Off> <On> †
-----------------



 <Menu> ▶ <Function Settings> ▶ <Common> ▶ <Scan Settings> ▶ <Auto Online> ▶ Select <Off> or <On> ▶ 

### <Auto Offline>

If scan is not performed within a specified period of time after the screen below is displayed (the machine is set online for scanning), the machine automatically becomes offline. Specify the time period at which the machine becomes offline.

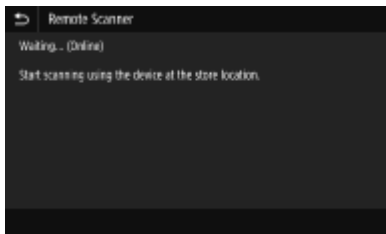

<b>&lt;Set This Function&gt;</b> <Off> <On> † <Set Time> 1 to 5 † to 60 (min.)
--



<Menu> ▶ <Function Settings> ▶ <Common> ▶ <Scan Settings> ▶ <Auto Offline> ▶ Select <On> in <Set This Function> ▶ Enter the time in <Set Time> ▶ <Apply> ▶

## <Generate File>

Configure file generation settings.

### <Output File Image Settings>

Specify settings for the gamma value for converting scanned originals into files.

#### <YCbCr TX Gamma Value>

Select the gamma value used when converting scanned color originals into the specified file format. You can specify the same gamma value as that of the monitor which is to be used for viewing the converted files. The files are displayed with brightness that is true to the original documents.

- <Gamma 1.0>
- <Gamma 1.4>
- <Gamma 1.8> †
- <Gamma 2.2>



<Menu> ▶ <Function Settings> ▶ <Common> ▶ <Generate File> ▶ <Output File Image Settings> ▶ <YCbCr TX Gamma Value> ▶ Select the gamma value ▶

### NOTE:

- For the gamma value of a monitor display, see the instruction manual included with the display.

### <OCR (Text Searchable) Settings>

To run OCR (Optical Character Recognition) on a text original to create a "searchable PDF," specify whether the machine determines the original's text direction and detects the original direction.

- <Smart Scan>
- <Off>
- <On> †



<Menu> ▶ <Function Settings> ▶ <Common> ▶ <Generate File> ▶ <OCR (Text Searchable) Settings> ▶ Select <Off> or <On> in <Smart Scan> ▶ <Apply> ▶

### <256-bit AES Set. (Encrypt. PDF)> \*1

When generating an encrypted PDF, the PDF encryption level can be set to "128-bit" or "256-bit." If "256-bit" is selected, the version compatible with Acrobat can be changed.

- <Acrobat 9.0 or Equivalent>



<Acrobat 10.0 or Equivalent> †



<Menu> ▶ <Function Settings> ▶ <Common> ▶ <Generate File> ▶ <256-bit AES Set. (Encrypt. PDF)> ▶ Select <Acrobat 9.0 or Equivalent> or <Acrobat 10.0 or Equivalent> ▶ 

## <Fax Setup Guide> \*1\*2

Select to display on-screen instructions for specifying settings, including the fax number and the RX mode.   
**Configuring Initial Settings for Fax Functions(P. 79)**

## <Copy>

261J-08W

All the settings related to the copy are listed with descriptions. Default settings are marked with a dagger (†).

### NOTE

#### Asterisks (\*)

- Settings marked with an asterisk (\*) may not be displayed depending on the model you are using, options, or other setting items.

### <Change Default Settings (Copy)>

You can change the default settings about copy. The selected settings are used as the default settings of the copy function. **Changing the Default Settings for Functions(P. 170)**

#### <Number of Copies>

1 † to 999

#### <Paper Source>

&lt;Multi-Purpose Tray&gt;

&lt;Drawer 1&gt; †

&lt;Drawer 2&gt;\*

&lt;Drawer 3&gt;\*

&lt;Drawer 4&gt;\*

#### <Density>

Nine Levels

&lt;Adjust Background Density&gt;

&lt;Auto&gt;

&lt;Adjust (Manual)&gt; †

Nine Levels

#### <Copy Ratio>

Custom Ratio

&lt;100% 1:1&gt; †

&lt;Auto&gt;

&lt;400% Max&gt;

&lt;200%&gt;

&lt;141% A5-&gt;A4&gt;

&lt;70% A4-&gt;A5&gt;

&lt;50%&gt;

&lt;25% Min&gt;

#### <2-Sided Printing>

&lt;Off&gt; †

&lt;1-Sided-&gt;2-Sided&gt;

<2-Sided->2-Sided>

<2-Sided->1-Sided>

<Orig./Fin. Type>

**<N on 1>**

<Off> †

<2 on 1>

<4 on 1>

<Layout>

**<Original Type>**

<Text>

<Text/Photo> †

<Text/Photo (High Quality)>

<Photo>

**<Collate>**

<Off>

<On> †

**<Erase Frame>**

<Off> †

<On>

**<Sharpness>**

Seven Levels

## <Printer>

All the settings related to the printer are listed with descriptions. Default settings are marked with a dagger (†).

▶<Printer Settings>(P. 492)

▶<PDL Selection (Plug and Play)>(P. 515)

### NOTE

#### Asterisks (\*)

- Settings marked with "\*1" may not be displayed depending on the model you are using, options, or other setting items.
- Settings marked with "\*2" cannot be imported or exported.

#### Priority of settings

- If a print setting is specified both from the printer driver and the operation panel of the machine, the specification from the printer driver overrides that from the operation panel. The specification from the operation panel becomes effective in some specific cases, such as when performing PS/PCL printing and printing from UNIX or other operating system that does not support printer drivers.



## <Printer Settings>

Configure settings about printing and printer operations.

### <Prioritize Driver Settings When Printing>

Select whether printing is performed in accordance with the printer driver's settings for paper size and type taking priority over the settings made for each paper source under <Paper Settings> in the Home screen. By selecting <On>, you can print from the paper source specified in the printer drive, regardless of the paper settings on the machine. An error message can be set to display if the loaded paper size is largely different from that set in the printer driver.

#### <Multi-Purpose Tray>

<Prioritize Driver Settings>

<Off> †

<On>

<Action When Size Mismatch>

<Force Output> †

<Display Error>

#### <Drawer 1>

<Prioritize Driver Settings>

<Off> †

<On>

<Action When Size Mismatch>

<p>&lt;Force Output&gt; †</p> <p>&lt;Display Error&gt;</p> <p><b>&lt;Drawer 2&gt;</b> *1</p> <p>&lt;Prioritize Driver Settings&gt;</p> <p>&lt;Off&gt; †</p> <p>&lt;On&gt;</p> <p>&lt;Action When Size Mismatch&gt;</p> <p>&lt;Force Output&gt; †</p> <p>&lt;Display Error&gt;</p> <p><b>&lt;Drawer 3&gt;</b> *1</p> <p>&lt;Prioritize Driver Settings&gt;</p> <p>&lt;Off&gt; †</p> <p>&lt;On&gt;</p> <p>&lt;Action When Size Mismatch&gt;</p> <p>&lt;Force Output&gt; †</p> <p>&lt;Display Error&gt;</p> <p><b>&lt;Drawer 4&gt;</b> *1</p> <p>&lt;Prioritize Driver Settings&gt;</p> <p>&lt;Off&gt; †</p> <p>&lt;On&gt;</p> <p>&lt;Action When Size Mismatch&gt;</p> <p>&lt;Force Output&gt; †</p> <p>&lt;Display Error&gt;</p>
---



<Menu> ▶ <Function Settings> ▶ <Printer> ▶ <Printer Settings> ▶ <Prioritize Driver Settings When Printing> ▶ Select the paper source ▶ Select <On> in <Prioritize Driver Settings> ▶ <Action When Size Mismatch> ▶ Select <Force Output> or <Display Error> ▶ <Apply> ▶ 

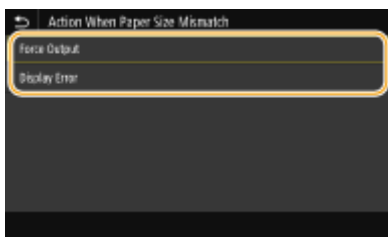

**<Force Output>**

Continue printing even when the paper size setting in the printer driver and the loaded paper are largely different.

**<Display Error>**

When the paper size setting in the printer driver and the loaded paper are largely different, an error message is displayed and printing is stopped.

**IMPORTANT**

- If the printer driver's settings do not match the size and type of loaded paper with <On> selected, a paper jam or printing error may occur.

### <Copies>

Set the number of copies to print.

1 + to 999



<Menu> ▶ <Function Settings> ▶ <Printer> ▶ <Printer Settings> ▶ <Copies> ▶ Set the number of copies to print ▶ <Apply> ▶

### <2-Sided Printing>

Select whether to make 2-sided printouts.

<Off> +  
<On>



<Menu> ▶ <Function Settings> ▶ <Printer> ▶ <Printer Settings> ▶ <2-Sided Printing> ▶ Select <Off> or <On> ▶

### <Default Paper>

Use this item to specify the paper size and type. **Available Paper(P. 673)**



<Menu> ▶ <Function Settings> ▶ <Printer> ▶ <Printer Settings> ▶ <Default Paper> ▶ Select the paper size ▶ Select the paper type ▶

### <Paper Size Override>

Select whether to switch between printing on A4 and Letter size paper if one of these paper sizes is loaded but the other is not. When you select <On>, if you specify A4 size paper to print from the computer but A4 size paper is not loaded in the machine, it will print your document on Letter size paper.

<Off> +  
<On>



<Menu> ▶ <Function Settings> ▶ <Printer> ▶ <Printer Settings> ▶ <Paper Size Override> ▶ Select <Off> or <On> ▶

## NOTE

- You can specify print settings, such as the number of copies or 1-sided/2-sided printing, from an application or the printer driver. However, the <Paper Size Override> setting can only be specified on the machine.

### <Print Quality>

You can change settings related to print quality.

#### <Density> \*1

Adjust the toner density.

##### 17 Levels

##### <Fine Adjust>

<High>/<Medium>/<Low>

17 Levels



<Menu> ▶ <Function Settings> ▶ <Printer> ▶ <Printer Settings> ▶ <Print Quality> ▶ <Density> ▶ Adjust the density ▶ <Apply> ▶

## NOTE

- You can use <Fine Adjust> to adjust the toner density to three density levels: high density, medium density, and low density.

### NOTE:

- When <Toner Save> is set to <On>, you cannot set this item.

### <Toner Save>

You can save toner consumption. Select <On> when you want to check the layout or other appearance characteristics before proceeding to final printing of a large job.

<Off> †

<On>





<Menu> ▶ <Function Settings> ▶ <Printer> ▶ <Printer Settings> ▶ <Print Quality> ▶ <Toner Save> ▶ Select <Off> or <On> ▶

### <Image Refinement>

Enable or disable the smoothing mode in which the edges of characters and graphics are smoothly printed.

<Off>



<On> †

 <Menu> ▶ <Function Settings> ▶ <Printer> ▶ <Printer Settings> ▶ <Print Quality> ▶ <Image Refinement> ▶ Select <Off> or <On> ▶ 

**<Resolution>**

Specify the resolution to be used for print data processing.

<1200 dpi>  
<600 dpi> †

 <Menu> ▶ <Function Settings> ▶ <Printer> ▶ <Printer Settings> ▶ <Print Quality> ▶ <Resolution> ▶ Select <1200 dpi> or <600 dpi> ▶ 



**<Layout>**

Specify the page layout settings such as binding position and margin values.

**<Binding Location>**

If you are binding the printouts with a binding tool such as a stapler, use this item to specify whether to bind on the long or short edge. Specify the setting of this item in combination with <Gutter>, which specifies the binding margin to apply to the binding position.

<Long Edge> †  
<Short Edge>

 <Menu> ▶ <Function Settings> ▶ <Printer> ▶ <Printer Settings> ▶ <Layout> ▶ <Binding Location> ▶ Select <Long Edge> or <Short Edge> ▶ 

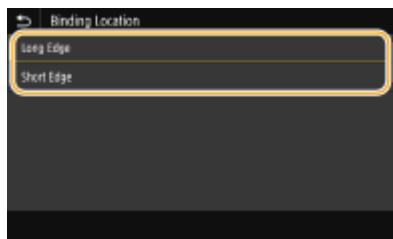

**<Long Edge>**

Specify this to bind on the long edge of paper.



**<Short Edge>**

Specify this to bind on the short edge of paper.





**<Gutter>**

Shift the print position to adjust the binding margin to apply to the binding edge specified by <Binding Location>. The value "00.0" exerts no effect on the binding margin.



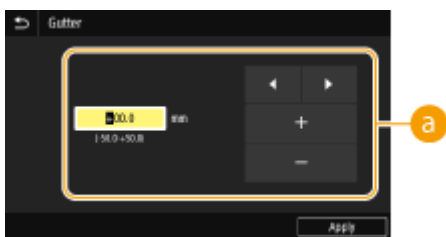

-50.0 to 00.0 <sup>†</sup> to +50.0 (mm)

<Menu> ▶ <Function Settings> ▶ <Printer> ▶ <Printer Settings> ▶ <Layout> ▶ <Gutter> ▶ Specify the binding margin ▶ <Apply> ▶

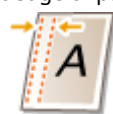

**a Entering the setting value**

Specify the print position shift direction and shift width. Whether the setting value is a "+" or "-" value determines the binding edge along which to adjust the binding margin. The margin width can be adjusted in 0.5 mm increments. ▶ **Basic Operation(P. 127)**

Setting Value	Long Edge	Short Edge
A value with a "+" sign	Left edge of paper 	Top edge of paper 
A value with a "-" sign	Right edge of paper 	Bottom edge of paper 

**<Offset Short Edge/Offset Long Edge>**

Irrespective of the paper source, you can shift the print position in units of "0.5 mm" for all print jobs.

-50.0 to 00.0 <sup>†</sup> to +50.0 (mm)

<Menu> ▶ <Function Settings> ▶ <Printer> ▶ <Printer Settings> ▶ <Layout> ▶ Select the combination of adjustment direction and printing side ▶ Specify the offset value ▶ <Apply> ▶

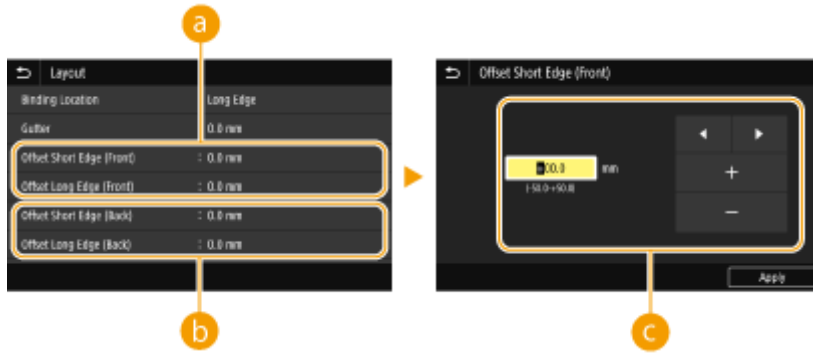

**a** <Offset Short Edge (Front)>/<Offset Long Edge (Front)>

Shifts the print position on the side of paper facing up.

**b** <Offset Short Edge (Back)>/<Offset Long Edge (Back)>

Shifts the print position on the side of paper facing down.

**c** Entering the setting value

For <Offset Short Edge (Front)>/<Offset Short Edge (Back)>, specify a value with a "+" sign to shift the print position in the left-to-right direction. For <Offset Long Edge (Front)>/<Offset Long Edge (Back)>, specify a value with a "+" sign to shift the print position in the up-to-down direction. To shift in the reverse direction, specify a value with a "-" sign. **Basic Operation(P. 127)**

<Offset Short Edge (Front)>  
<Offset Short Edge (Back)>

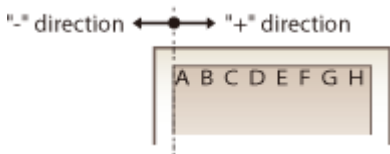

<Offset Long Edge (Front)>  
<Offset Long Edge (Back)>

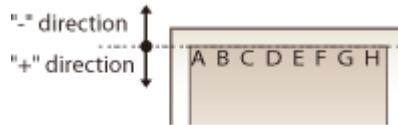

**<Auto Skip Error>**

Printing stops if a certain error occurs in the process. However, if you set this item to <On>, the certain error will be skipped and printing can continue. Normally, set this item to <Off>.

<Off> +  
<On>



<Menu> ▶ <Function Settings> ▶ <Printer> ▶ <Printer Settings> ▶ <Auto Skip Error> ▶ Select <Off> or <On> ▶

**<Timeout>**

Set the time period after which the current print job is automatically canceled in the case of a print data reception interruption.

5 to 15 + to 300 (sec.)



<Menu> ▶ <Function Settings> ▶ <Printer> ▶ <Printer Settings> ▶ <Timeout> ▶ Set the time period ▶ <Apply> ▶ 

### <Personality>

Specify the mode in which the machine should operate when the format of document data is unknown.

<Auto> †  
 <PS>  
 <PCL>  
 <PDF>  
 <XPS>  
 <Imaging>



<Menu> ▶ <Function Settings> ▶ <Printer> ▶ <Printer Settings> ▶ <Personality> ▶ Select the Personality mode ▶ 

### <Prioritize MP Tray>

Specify whether to feed paper from the multi-purpose tray when Auto Select Paper is enabled. If <On> is selected, paper is fed from the multi-purpose tray when paper of the same size and same type is loaded in both the multi-purpose tray and paper drawer.

<Off> †  
 <On>



<Menu> ▶ <Function Settings> ▶ <Printer> ▶ <Printer Settings> ▶ <Prioritize MP Tray> ▶ Select <Off> or <On> ▶ 

### <UFR II>

You can change the settings that become effective when printing from the UFR II printer driver.

#### <Halftones>

You can select the printing method used to reproduce halftones (the intermediate range between the lighter and darker areas of an image) for optimal image quality.

##### <Resolution/Gradation>

Select a method used to reproduce halftones. This option can be specified for each image type in any one document.

<Text>  
 <Resolution> †  
 <Color Tone>  
 <Gradation>  
 <High Resolution>

<p><b>&lt;Graphics&gt;</b>                  &lt;Resolution&gt;                  &lt;Color Tone&gt; †                  &lt;Gradation&gt;                  &lt;High Resolution&gt;</p> <p><b>&lt;Image&gt;</b>                  &lt;Resolution&gt;                  &lt;Color Tone&gt; †                  &lt;Gradation&gt;                  &lt;High Resolution&gt;</p>
--

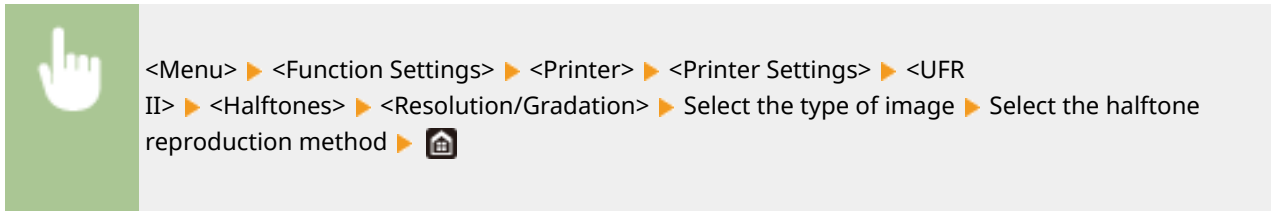

**a Type of image**

Select the object for which to change the setting. <Text> represents letters and characters, <Graphics> represents lines and figures, and <Image> represents photos and images.

**b Setting value**

**<Resolution>**

Produces a fine print with clear edges of text. It is suitable for printing characters and fine lines.

**<Color Tone>**

Produces a sharp print with strong contrast of lightness and darkness. It is suitable for printing image data such as photo image data.

**<Gradation>**

Produces a print with smooth gradation or smooth edges. It is suitable for printing figures or graphs containing gradation areas.

**<High Resolution>**

As compared to <Resolution>, this produces a finer print but quality stability is slightly lower. It is suitable to obtain a print of character data or fine line data or CAD data with sharp edges.

**<Paper Save>**

Specify whether to disable a blank page in print data from being output.

<p>&lt;Off&gt;                  &lt;On&gt; †</p>
--



<Menu> ▶ <Function Settings> ▶ <Printer> ▶ <Printer Settings> ▶ <UFR II> ▶ <Paper Save> ▶ Select <Off> or <On> ▶

## <PCL>

Specify the PCL printing settings such as page layout and print quality.

### <Paper Save>

Specify whether to disable a blank page in print data from being output.

<Off> +  
<On>



<Menu> ▶ <Function Settings> ▶ <Printer> ▶ <Printer Settings> ▶ <PCL> ▶ <Paper Save> ▶ Select <Off> or <On> ▶

### <Orientation>

Select <Portrait> (vertical orientation) or <Landscape> (horizontal orientation) for the page orientation.

<Portrait> +  
<Landscape>



<Menu> ▶ <Function Settings> ▶ <Printer> ▶ <Printer Settings> ▶ <PCL> ▶ <Orientation> ▶ Select <Portrait> or <Landscape> ▶

### <Font Number>

Specify the font to use by selecting a corresponding font ID number. You can print the PCL font list with font samples from the operation panel. **PCL Font List(P. 585)**

0 + to 104



<Menu> ▶ <Function Settings> ▶ <Printer> ▶ <Printer Settings> ▶ <PCL> ▶ <Font Number> ▶ Select the font number ▶ <Apply> ▶

### <Point Size> \*1

Set the font size in points, adjustable in 0.25 increments. You can specify this setting only when a proportionally-spaced scalable font is selected in <Font Number>.

4.00 to 12.00 + to 999.75 (point)



<Menu> ▶ <Function Settings> ▶ <Printer> ▶ <Printer Settings> ▶ <PCL> ▶ <Point Size> ▶ Specify the point size ▶ <Apply> ▶ 

**<Pitch> \*1**

Set the font pitch, or cpi (characters per inch), adjustable in 0.01 increments. You can specify this setting only when a fixed-pitch scalable font or a bitmap font is selected in <Font Number>.

0.44 to 10.00 † to 99.99 (cpi)





<Menu> ▶ <Function Settings> ▶ <Printer> ▶ <Printer Settings> ▶ <PCL> ▶ <Pitch> ▶ Specify the pitch value ▶ <Apply> ▶ 

**<Form Lines>**

Set the number of lines printed on one page from 5 to 128. This setting is automatically changed according to the settings specified in <Default Paper Size> and <Orientation>.

5 to 64 † to 128 (lines)



<Menu> ▶ <Function Settings> ▶ <Printer> ▶ <Printer Settings> ▶ <PCL> ▶ <Form Lines> ▶ Specify the number of lines ▶ <Apply> ▶ 

**<Character Code>**

Select the character code that is most suited for the computer you send print data from. The specified setting is ignored when the character code is controlled by the font specified in <Font Number>.

<ARABIC8>	<PC8> †
<DESKTOP>	<PC850>
<GREEK8>	<PC851>
<HEBREW7>	<PC852>
<HEBREW8>	<PC858>
<ISO4>	<PC862>
<ISO6>	<PC864>
<ISO11>	<PC866>
<ISO15>	<PC8DN>
<ISO17>	<PC8GRK>
<ISO21>	<PC8TK>
<ISO60>	<PC1004>
<ISO69>	<PIFONT>
<ISOCYR>	<PSMATH>
<ISOGRK>	<PSTEXT>
<ISOHEB>	<ROMAN8>
<ISOL1>	<ROMAN9>
<ISOL2>	<VNINTL>

<ISOL5>	<VNMATH>
<ISOL6>	<VNUS>
<ISOL9>	<WIN30>
<LEGAL>	<WINARB>
<MATH8>	<WINBALT>
<MCTEXT>	<WINCYR>
<MSPUBL>	<WINGRK>
<PC775>	<WINL1>
	<WINL2>
	<WINL5>



<Menu> ▶ <Function Settings> ▶ <Printer> ▶ <Printer Settings> ▶ <PCL> ▶ <Character Code> ▶ Select the character code ▶ 

### <Custom Paper>

Select whether to set a custom paper size. Select <On> to set the dimensions of the paper in <X dimension> and <Y dimension>.

<Off> †  
<On>





<Menu> ▶ <Function Settings> ▶ <Printer> ▶ <Printer Settings> ▶ <PCL> ▶ <Custom Paper> ▶ Select <Off> or <On> ▶ 

### <Unit of Measure> \*1

Select the unit of measurement to use to set a custom paper size.

<Millimeter> †  
<Inch>





<Menu> ▶ <Function Settings> ▶ <Printer> ▶ <Printer Settings> ▶ <PCL> ▶ <Unit of Measure> ▶ Select <Millimeter> or <Inch> ▶ 

### <X dimension> \*1

Specify the horizontal dimension (short edge) of the custom paper.



77 to 215 † (mm)

 <Menu> ▶ <Function Settings> ▶ <Printer> ▶ <Printer Settings> ▶ <PCL> ▶ <X dimension> ▶ Specify the dimension ▶ <Apply> ▶ 

**<Y dimension> \*1**

Specify the vertical dimension (long edge) of the custom paper.

127 to 355 † (mm)

 <Menu> ▶ <Function Settings> ▶ <Printer> ▶ <Printer Settings> ▶ <PCL> ▶ <Y dimension> ▶ Specify the dimension ▶ <Apply> ▶ 

**<Append CR to LF>**

Select whether to append a carriage return (CR) when the machine receives a line feed code (LF). If <Yes> is selected, the print position moves to the beginning of the next line when the machine receives an LF code. If <No> is selected, the print position moves to the next line, just under the received LF code.

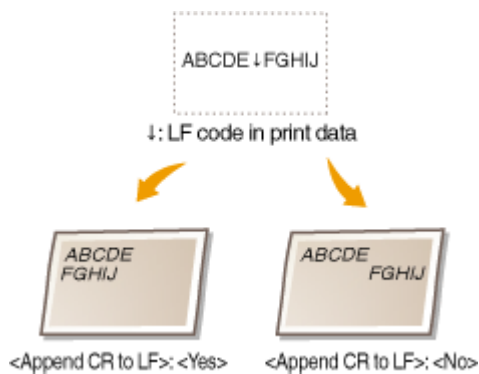

<Yes>  
<No> †

 <Menu> ▶ <Function Settings> ▶ <Printer> ▶ <Printer Settings> ▶ <PCL> ▶ <Append CR to LF> ▶ Select <Yes> or <No> ▶ 

**<Enlarge A4 Print Width>**

Select whether to expand the width of the printable area of A4 size paper in portrait orientation to that of Letter size.

<Off> †  
<On>



 <Menu> ▶ <Function Settings> ▶ <Printer> ▶ <Printer Settings> ▶ <PCL> ▶ <Enlarge A4 Print Width> ▶ Select <Off> or <On> ▶ 



<Halftones>

You can select the printing method used to reproduce halftones (the intermediate range between the lighter and darker areas of an image) for optimal image quality.

<Resolution/Gradation>

Select a method used to reproduce halftones. This option can be specified for each image type in any one document.

<b>&lt;Text&gt;</b>	
<Resolution>	†
<Color Tone>	
<Gradation>	
<High Resolution>	
<b>&lt;Graphics&gt;</b>	
<Resolution>	
<Color Tone>	†
<Gradation>	
<High Resolution>	
<b>&lt;Image&gt;</b>	
<Resolution>	
<Color Tone>	†
<Gradation>	
<High Resolution>	

 <Menu> ▶ <Function Settings> ▶ <Printer> ▶ <Printer Settings> ▶ <PCL> ▶ <Halftones> ▶ <Resolution/Gradation> ▶ Select the type of image ▶ Select the halftone reproduction method ▶ 



**a** Type of image

Select the object for which to change the setting. <Text> represents letters and characters, <Graphics> represents lines and figures, and <Image> represents photos and images.

## **b** Setting value

### **<Resolution>**

Produces a fine print with clear edges of text. It is suitable for printing characters and fine lines.

### **<Color Tone>**

Produces a sharp print with strong contrast of lightness and darkness. It is suitable for printing image data such as photo image data.

### **<Gradation>**

Produces a print with smooth gradation or smooth edges. It is suitable for printing figures or graphs containing gradation areas.

### **<High Resolution>**

As compared to <Resolution>, this produces a finer print but quality stability is slightly lower. It is suitable to obtain a print of character data or fine line data or CAD data with sharp edges.

### **<BarDIMM> \*1**

This setting enables you to print bar codes supported by the Barcode Printing Kit. If <Enable> is selected, the machine will generate bar codes when it receives bar code commands from the host computer. If <Disable> is selected, bar codes will not be generated, even if bar code commands are sent from the host computer.

<Disable> †  
<Enable>



<Menu> ▶ <Function Settings> ▶ <Printer> ▶ <Printer Settings> ▶ <PCL> ▶ <BarDIMM> ▶ Select <Disable> or <Enable> ▶ 

## **IMPORTANT:**

- To enable the BarDIMM menu, it is necessary to activate the Barcode Printing Kit. When you are not printing bar codes, make sure to disable the BarDIMM menu. Otherwise, the processing speed of regular print jobs may be reduced.

## **NOTE:**

- The default setting is <Disable>. If you activate the Barcode Printing Kit, it changes to <Enable>.

### **<FreeScape> \*1**

Specify the AEC (Alternate Escape Code) to be used for bar code commands when the host computer does not support the standard Escape Code.

<Off>  
<~> †  
<">  
<#>  
<\$>  
</>  
<\>  
<?>  
<{>  
<}>  
<|>



<Menu> ▶ <Function Settings> ▶ <Printer> ▶ <Printer Settings> ▶ <PCL> ▶ <FreeScape> ▶ Select an escape code ▶ 

**NOTE:**

- This setting is available only when <BarDIMM> is enabled.

**<PS>**

Specify the PS printing settings such as page layout and print quality.

**<Job Timeout>**

This setting enables you to specify the amount of time before a job times out. If a job has not finished within the set time limit, the job automatically cancels.

0 † to 3600 (sec.)



<Menu> ▶ <Function Settings> ▶ <Printer> ▶ <Printer Settings> ▶ <PS> ▶ <Job Timeout> ▶ Specify the seconds for job timeout ▶ <Apply> ▶ 

**<Print PS Errors>**

This setting determines whether an error page is printed when an error is encountered.

<Off> †  
<On>



<Menu> ▶ <Function Settings> ▶ <Printer> ▶ <Printer Settings> ▶ <PS> ▶ <Print PS Errors> ▶ Select <Off> or <On> ▶ 

**<Halftones>**

You can select the printing method used to reproduce halftones (the intermediate range between the lighter and darker areas of an image) for optimal image quality.



**<Resolution/Gradation>**

Select a method used to reproduce halftones. This option can be specified for each image type in any one document.

**<Text>**  
<Resolution> †  
<Gradation>  
<High Resolution>

**<Graphics>**  
<Resolution> †  
<Gradation>

<High Resolution>  
**<Image>**  
 <Resolution> †  
 <Gradation>  
 <High Resolution>

 <Menu> ▶ <Function Settings> ▶ <Printer> ▶ <Printer Settings> ▶ <PS> ▶ <Halftones> ▶ <Resolution/Gradation> ▶ Select the type of image ▶ Select the halftone reproduction method ▶ 



**a Type of image**

Select the object for which to change the setting. <Text> represents letters and characters, <Graphics> represents lines and figures, and <Image> represents photos and images.

**b Setting value**

**<Resolution>**

Produces a print with smooth gradation or smooth edges. It is suitable for printing figures or graphs containing gradation areas.

**<Gradation>**

Produces a sharp print with strong contrast of lightness and darkness. It is suitable for printing image data such as photo image data.



**<High Resolution>**

Produces a fine print with clear edges of text. It is suitable for printing characters and fine lines.

**<Grayscale Conversion>**

Specify the way of printing color data in black and white.

<sRGB>  
 <NTSC> †  
 <Uniform RGB>

 <Menu> ▶ <Function Settings> ▶ <Printer> ▶ <Printer Settings> ▶ <PS> ▶ <Grayscale Conversion> ▶ Select the type of grayscale conversion ▶ 

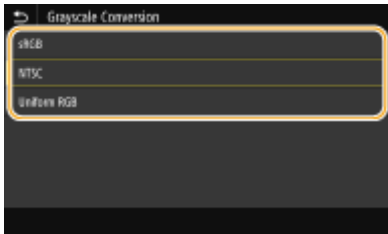

**<sRGB>**

Prints in black and white with emphasis on color differences so that a smooth gradation is achieved.

**<NTSC>**

Prints in black and white so that the resulting image looks like a black and white television picture (of the NTSC system).

**<Uniform RGB>**

Prints in black and white so that R, G, and B are uniformly converted to the same gray level by using only brightness as the reference.



**<Imaging Settings>**

You can change the print settings that will apply when printing image files (JPEG/TIFF).

**<Halftones>**

You can change the printing method used to reproduce halftones (the intermediate range between the lighter and darker areas of an image) for optimal image quality.



 <Menu> ▶ <Function Settings> ▶ <Printer> ▶ <Printer Settings> ▶ <Imaging Settings> ▶ <Halftones> ▶ Select the halftone reproduction method ▶ 

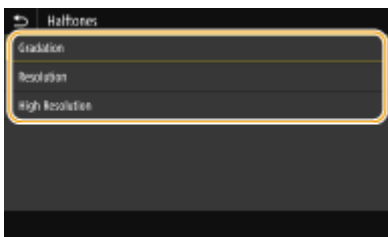

**<Gradation>**

Produces a sharp print with strong contrast of lightness and darkness. It is suitable for printing image data such as photo image data.

**<Resolution>**

Produces a print with smooth gradation or smooth edges. It is suitable for printing figures or graphs containing gradation areas.

**<High Resolution>**

Produces a fine print with clear edges of text. It is suitable for printing characters and fine lines.

**<PDF>**

You can change settings for PDF files.

### <Enlarge/Reduce to Fit Paper Size>

Specify whether to enlarge or reduce the original according to the print range of paper. Note that size enlargement/reduction will not affect the aspect ratio of the original.

<Off> †  
<On>



<Menu> ▶ <Function Settings> ▶ <Printer> ▶ <Printer Settings> ▶ <PDF> ▶ <Enlarge/Reduce to Fit Paper Size> ▶ Select <Off> or <On> ▶ 

### <Enlarge Print Area>

Specify whether to extend the print range to the paper size.

<Off> †  
<On>



<Menu> ▶ <Function Settings> ▶ <Printer> ▶ <Printer Settings> ▶ <PDF> ▶ <Enlarge Print Area> ▶ Select <Off> or <On> ▶ 

### NOTE:

- If you specify <On>, it may occur that edge-adjacent portions of page are not printed or that printouts come out partially smudged depending on the original.

### <N on 1>

Specify whether to shrink multiple pages and print them on one page in such arrangement that the first page is positioned at top left. For example, to print 4 pages onto a single sheet, select <4 on 1>.

<Off> †  
<2 on 1>  
<4 on 1>  
<6 on 1>  
<8 on 1>  
<9 on 1>  
<16 on 1>



<Menu> ▶ <Function Settings> ▶ <Printer> ▶ <Printer Settings> ▶ <PDF> ▶ <N on 1> ▶ Select the number of pages to be combined ▶ 

### <Print Comments>

Specify whether to print comments. If you specify <Auto>, comments in PDF files will be printed.

<Off>

<Auto> †

 <Menu> ▶ <Function Settings> ▶ <Printer> ▶ <Printer Settings> ▶ <PDF> ▶ <Print Comments> ▶ Select <Off> or <Auto> ▶ 

<Halftones>

You can select the printing method used to reproduce halftones (the intermediate range between the lighter and darker areas of an image) for optimal image quality.



<Resolution/Gradation>

Select a method used to reproduce halftones. This option can be specified for each image type in any one document.

**<Text>**  
 <Resolution> †  
 <Gradation>  
 <High Resolution>

**<Graphics>**  
 <Resolution> †  
 <Gradation>  
 <High Resolution>

**<Image>**  
 <Resolution> †  
 <Gradation>  
 <High Resolution>

 <Menu> ▶ <Function Settings> ▶ <Printer> ▶ <Printer Settings> ▶ <PDF> ▶ <Halftones> ▶ <Resolution/Gradation> ▶ Select the type of image ▶ Select the halftone reproduction method ▶ 



**a Type of image**

Select the object for which to change the setting. <Text> represents letters and characters, <Graphics> represents lines and figures, and <Image> represents photos and images.

## b Setting value

### <Resolution>

Produces a print with smooth gradation or smooth edges. It is suitable for printing figures or graphs containing gradation areas.

### <Gradation>

Produces a sharp print with strong contrast of lightness and darkness. It is suitable for printing image data such as photo image data.

### <High Resolution>

Produces a fine print with clear edges of text. It is suitable for printing characters and fine lines.

## <Grayscale Conversion>

Specify the way of printing color data in black and white.

<sRGB>  
<NTSC> †  
<Uniform RGB>



<Menu> ▶ <Function Settings> ▶ <Printer> ▶ <Printer Settings> ▶ <PDF> ▶ <Grayscale Conversion> ▶ Select the type of grayscale conversion ▶

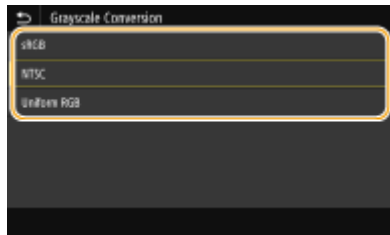

### <sRGB>

Prints in black and white with emphasis on color differences so that a smooth gradation is achieved.

### <NTSC>

Prints in black and white so that the resulting image looks like a black and white television picture (of the NTSC system).

### <Uniform RGB>

Prints in black and white so that R, G, and B are uniformly converted to the same gray level by using only brightness as the reference.

## <XPS>

You can change settings for XPS files.

## <Halftones>

You can select the printing method used to reproduce halftones (the intermediate range between the lighter and darker areas of an image) for optimal image quality.



### <Resolution/Gradation>

Select a method used to reproduce halftones. This option can be specified for each image type in any one document.

<Text>



<Resolution> †
<Gradation>
<High Resolution>
<b>&lt;Graphics&gt;</b>
<Resolution> †
<Gradation>
<High Resolution>
<b>&lt;Image&gt;</b>
<Resolution> †
<Gradation>
<High Resolution>

 <Menu> ▶ <Function Settings> ▶ <Printer> ▶ <Printer Settings> ▶ <XPS> ▶ <Halftones> ▶ <Resolution/Gradation> ▶ Select the type of image ▶ Select the halftone reproduction method ▶ 



**a Type of image**

Select the object for which to change the setting. <Text> represents letters and characters, <Graphics> represents lines and figures, and <Image> represents photos and images.

**b Setting value**

**<Resolution>**

Produces a print with smooth gradation or smooth edges. It is suitable for printing figures or graphs containing gradation areas.

**<Gradation>**

Produces a sharp print with strong contrast of lightness and darkness. It is suitable for printing image data such as photo image data.

**<High Resolution>**

Produces a fine print with clear edges of text. It is suitable for printing characters and fine lines.

**<Grayscale Conversion>**

Specify the way of printing color data in black and white.

<Text>
<sRGB>
<NTSC> †

<Uniform RGB>
<b>&lt;Graphics&gt;</b>
<sRGB>
<NTSC> †
<Uniform RGB>
<b>&lt;Image&gt;</b>
<sRGB>
<NTSC> †
<Uniform RGB>



<Menu> ▶ <Function Settings> ▶ <Printer> ▶ <Printer Settings> ▶ <XPS> ▶ <Grayscale Conversion> ▶ Select the type of image ▶ Select the type of grayscale conversion ▶



### a Type of image

Select the object for which to change the setting. <Text> represents letters and characters, <Graphics> represents lines and figures, and <Image> represents photos and images.

### b Type of grayscale conversion

#### <sRGB>

Prints in black and white with emphasis on color differences so that a smooth gradation is achieved.

#### <NTSC>

Prints in black and white so that the resulting image looks like a black and white television picture (of the NTSC system).

#### <Uniform RGB>

Prints in black and white so that R, G, and B are uniformly converted to the same gray level by using only brightness as the reference.

### <Paper Save>

Specify whether to disable a blank page in print data from being output.

<Off> †
<On>



<Menu> ▶ <Function Settings> ▶ <Printer> ▶ <Printer Settings> ▶ <XPS> ▶ <Paper Save> ▶ Select <Off> or <On> ▶ 

### <Compressed Image Output>

Specify the operation that is to be performed when the image quality has degraded due to insufficient memory during printing.

<Output> †  
<Display Error>



<Menu> ▶ <Function Settings> ▶ <Printer> ▶ <Printer Settings> ▶ <XPS> ▶ <Compressed Image Output> ▶ Select <Output> or <Display Error> ▶ 

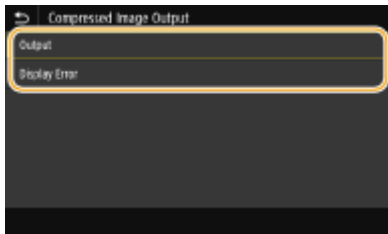

#### <Output>

Continues printing regardless of how much the image quality has degraded.

#### <Display Error>

If the image quality has degraded significantly, an error message is displayed, and printing is stopped.

## <PDL Selection (Plug and Play)>

Select a page description language so that the machine is detected as a printer that is compatible with that language when it is connected to a computer by using Plug and Play.

### <Network> \*2

Select a page description language so that the machine is detected as a printer that is compatible with that language when it is detected over the network.

<FAX>\*1  
<UFR II> †  
<UFR II (V4)>  
<PCL6>  
<PCL6 (V4)>  
<PS>

### <USB>

Select a page description language so that the machine is detected as a printer that is compatible with that language when it is connected to a computer via USB.

<UFR II> †

<UFR II (V4)>  
 <PCL6>  
 <PCL6 (V4)>  
 <PS>



<Menu> ▶ <Function Settings> ▶ <Printer> ▶ <PDL Selection (Plug and Play)> ▶ Select <Network> or <USB> ▶ Select a page description language ▶ <OK> ▶ Restart the machine

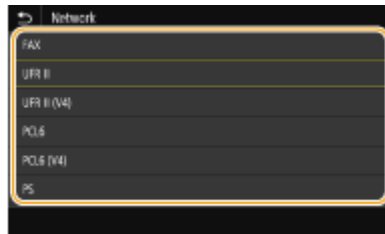
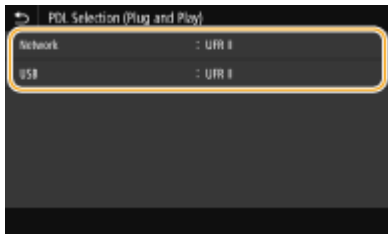

**<FAX>**

Detects and connects the machine as a fax device.

**<UFR II>**

Detects and connects the machine as a UFR II printer.

**<UFR II (V4)>**

Detects and connects the machine as a UFR II printer that is compatible with XML Paper Specification (XPS).

**<PCL6>**

Detects and connects the machine as a PCL6 printer.

**<PCL6 (V4)>**

Detects and connects the machine as a PCL6 printer.

**<PS>**

Detects and connects the machine as a PS printer.

## <Send>

261J-08Y

All the settings related to sending faxes and scanned originals are listed with descriptions. Default settings are marked with a dagger (†).

▶<Common Settings>(P. 517)

▶<Scan and Send Settings>(P. 518)

▶<Fax Settings>(P. 522)

### NOTE

#### Asterisks (\*)

- Settings marked with "\*"1" may not be displayed depending on the model you are using, options, or other setting items.
- Settings marked with "\*"2" may be unavailable or vary or have different defaults depending on your country or region.
- Settings marked with "\*"3" cannot be imported or exported.

### <Common Settings>

Configure the settings to restrict destinations at the time of sending faxes, e-mails, or I-Faxes, and specify the confirmation method to prevent transmission to wrong destinations.

#### <Restrict New Destinations>

Select whether to limit the fax numbers and e-mail/I-Fax addresses that can be specified as destinations to those already registered in the Address Book. ▶<Restricting New Destinations that Can Be Specified>(P. 403)

<Off> †  
<On>

#### <Restrict Resending from Log>

Select whether to prevent a destination from being selected from the sent job logs. ▶<Disabling Use of Previously Used Destinations>(P. 403)

<Off> †  
<On>

#### <Confirm When Coded Dial TX>

Select whether to display the details of an entered coded dial number when it is selected as a destination. ▶<Displaying Destinations in Address Book>(P. 403)

<Off> †  
<On>

#### <Confirm Dest. Before Sending>

Specify whether to display the destination confirmation screen when sending faxes, e-mails, or I-Faxes. If <Only for Sequential Broadcast> is selected, the confirmation screen is displayed only when multiple destinations are specified. ▶<Checking Destinations when Sending Data>(P. 404)

<Off> †

<On>  
<Only for Sequential Broadcast>

## <Scan and Send Settings>

You can change and register the settings for sending faxes or scanned documents.

### <Register Unit Name>

Register the sender name for e-mails and I-Faxes. The registered name is displayed in e-mails, along with the e-mail address. If the sender name is not registered, only the e-mail address is displayed.



<Menu> ▶ <Function Settings> ▶ <Send> ▶ <Scan and Send Settings> ▶ <Register Unit Name> ▶ Enter the sender name ▶ <Apply> ▶

### <E-Mail Settings>

Change the default settings used for scanning originals to send as e-mails.

### <Change Default Settings (E-Mail)>

You can change the default settings used for scanning originals to send as e-mails. The selected settings are used as the default settings when scanning originals. **Changing the Default Settings for Functions(P. 170)**

#### <Scan Size>

<A4>   
<A5R>  
<A6>  
<B5>  
<LTR>  
<LGL>  
<STMT>  
<EXEC>  
<FOOLSCAP/FOLIO>  
<OFICIO>  
<LETTER (Government)>  
<LEGAL (Government)>  
<LEGAL (India)>  
<FOOLSCAP (Australia)>  
<OFICIO (Brazil)>  
<OFICIO (Mexico)>

#### <File Format>

<PDF>   
<PDF (Compact)>  
<PDF (Compact/OCR)>  
<PDF (OCR)>  
<Set PDF Details>  
<PDF>/<PDF (Compact)>/<PDF (Compact/OCR)>/<PDF (OCR)>  
<Encryption>

- <None> †
- <Acrobat 7.0 or Later/128-bit AES>
- <Acrobat 9.0 or Equivalent/256-bit AES>\*1
- <Acrobat 10.0 or Equivalent/256-bit AES>\*1
- <Digital Signatures>
- <None> †
- <Top Left>
- <Divide into Pages>
- <Off> †
- <On>
- <JPEG>
- <TIFF>
- <Set TIFF Details>
- <Divide into Pages>
- <Off> †
- <On>
- <Density>**
- Nine Levels
- <Original Orientation>**
- <Portrait> †
- <Landscape>
- <Original Type>**
- <Text>
- <Text/Photo> †
- <Photo>
- <2-Sided Original >**
- <Off> †
- <Book Type>
- <Calendar Type>
- <Sharpness>**
- Seven Levels
- <Data Size>**
- <Small: Memory Priority>
- <Standard> †
- <Large: Image Quality Priority>
- <Subject/Message>**
- <Subject>
- <Message>
- <Reply To>**
- <None> †
- <Specify from Address Book>
- <Priority>**

<Low>  
 <Standard> †  
 <High>

## <I-Fax Settings>

Specify the basic settings for using the machine as an I-Fax device.

### <Change Default Settings (I-Fax)>

You can change the default settings used for sending I-Fax. The selected settings are used as the default settings when scanning originals.  **Changing the Default Settings for Functions(P. 170)**

#### <Scan Size>

<A4> †  
 <A5R>  
 <A6>  
 <B5>  
 <LTR>  
 <LGL>  
 <STMT>  
 <EXEC>  
 <FOOLSCAP/FOLIO>  
 <OFICIO>  
 <LETTER (Government)>  
 <LEGAL (Government)>  
 <LEGAL (India)>  
 <FOOLSCAP (Australia)>  
 <OFICIO (Brazil)>  
 <OFICIO (Mexico)>

#### <Density>

Nine Levels

#### <Original Type>

<Text> †  
 <Text/Photo>  
 <Photo>

#### <2-Sided Original >

<Off> †  
 <Book Type>  
 <Calendar Type>

#### <Sharpness>

Seven Levels

#### <Subject/Message>

<Subject>  
 <Message>

#### <Reply To>

<None> †





<Specify from Address Book>

### <TX Terminal ID>

Information such as the date and time of transmission and the e-mail address of the machine (sender information) can be added as a header in transmitted documents. This information tells the recipient when the I-Fax was sent and who sent it.

- <Add TX Terminal ID>
  - <Off>
  - <On> †
  - <Print Position>
    - <Inside Image Area>
    - <Outside Image Area> †



<Menu> ▶ <Function Settings> ▶ <Send> ▶ <Scan and Send Settings> ▶ <I-Fax Settings> ▶ <TX Terminal ID> ▶ Select <On> in <Add TX Terminal ID> ▶ <Print Position> ▶ Select <Inside Image Area> or <Outside Image Area> ▶ <Apply> ▶ 

### <File Settings>

Change the default settings used when originals are saved to a shared folder or FTP server.

#### <Change Default Settings (File)>

You can change the default settings used when originals are saved to a shared folder or FTP server. The selected settings are used as the default settings when scanning.  **Changing the Default Settings for Functions(P. 170)**

- <Scan Size>
  - <A4> †
  - <A5R>
  - <A6>
  - <B5>
  - <LTR>
  - <LGL>
  - <STMT>
  - <EXEC>
  - <FOOLSCAP/FOLIO>
  - <OFICIO>
  - <LETTER (Government)>
  - <LEGAL (Government)>
  - <LEGAL (India)>
  - <FOOLSCAP (Australia)>
  - <OFICIO (Brazil)>
  - <OFICIO (Mexico)>
- <File Format>
  - <PDF> †
  - <PDF (Compact)>
  - <PDF (Compact/OCR)>

<PDF (OCR)>  
 <Set PDF Details>  
   <PDF>/<PDF (Compact)>/<PDF (Compact/OCR)>/<PDF (OCR)>  
     <Encryption>  
       <None> †  
       <Acrobat 7.0 or Later/128-bit AES>  
       <Acrobat 9.0 or Equivalent/256-bit AES>\*1  
       <Acrobat 10.0 or Equivalent/256-bit AES>\*1  
     <Digital Signatures>  
       <None> †  
       <Top Left>  
     <Divide into Pages>  
       <Off> †  
       <On>  
 <JPEG>  
 <TIFF>  
 <Set TIFF Details>  
   <Divide into Pages>  
     <Off> †  
     <On>  
  
**<Density>**  
 Nine Levels  
  
**<Original Orientation>**  
 <Portrait> †  
 <Landscape>  
  
**<Original Type>**  
 <Text>  
 <Text/Photo> †  
 <Photo>  
  
**<2-Sided Original>**  
 <Off> †  
 <Book Type>  
 <Calendar Type>  
  
**<Sharpness>**  
 Seven Levels  
  
**<Data Size>**  
 <Small: Memory Priority>  
 <Standard> †  
 <Large: Image Quality Priority>

## <Fax Settings> \*1

Specify the basic settings for using the machine as a fax device.

## <Change Default Settings (Fax)>

You can change the default settings used for sending faxes. The selected settings are used as the default settings when scanning originals.  **Changing the Default Settings for Functions(P. 170)**

### <Resolution>

<200 x 100 dpi (Normal)>   
 <200 x 200 dpi (Fine)>  
 <200 x 200 dpi (Photo)>  
 <200 x 400 dpi (Superfine)>  
 <400 x 400 dpi (Ultrafine)>

### <Density>

Nine Levels

### <2-Sided Original >

<Off>   
 <Book Type>  
 <Calendar Type>

### <Sharpness>









Seven Levels

## <Off-Hook Alarm>

Select whether the machine makes an alert sound when the handset of a telephone or the optional handset connected to the machine is not properly set on the cradle. You can also adjust the volume of the alert sound.

0  to 3



<Menu>  <Function Settings>  <Send>  <Fax Settings>  <Off-Hook Alarm>  Select the volume of the alert sound  <Apply>  

## <ECM TX>

Enable or disable error correction mode (ECM). ECM checks for fax data errors and corrects them. To reduce errors on received faxes, see  **<ECM RX>(P. 531)** .

<Off>  
 <On> 



<Menu>  <Function Settings>  <Send>  <Fax Settings>  <ECM TX>  <On>  

## NOTE

- ECM must be enabled on both the machine and the other fax device because error checks are performed on both the sending and receiving devices.

- Even when ECM is enabled, errors may occur due to telephone line conditions.
- It may take a longer time than usual to process data when ECM is enabled because the error checks and corrections are performed while the data is transmitted.

### <Set Pause Time> \*2

For example, when you make calls by dialing "0 - (pause) - (telephone number)," 0 is dialed first and then a few seconds later, the telephone number. When sending faxes overseas, you need to specify destinations by dialing "(international access code) - (country code) - (area code) - (fax number)" but consecutive numbers that are input without pauses may not be recognized correctly. In this case, try adding a pause after the international access code or the fax number. If the code or the number is still not recognized correctly, change the duration of the pause. For instructions on how to enter a pause, see **Basic Operations for Sending Faxes(P. 214)** .

1 to 4 <sup>†</sup> to 15 (sec.)



<Menu> ▶ <Function Settings> ▶ <Send> ▶ <Fax Settings> ▶ <Set Pause Time> ▶ Specify the duration of pause ▶ <Apply> ▶

### <Auto Redial> \*2

Specify settings for Auto Redial, a function that automatically redials the fax number after several minutes if the first attempt fails because the line is busy. You can specify how many times the machine redials and the interval between redials.

#### <Use Auto Redial>

<Off>

<On> <sup>†</sup>

<Number of Times to Redial>

1 to 2 <sup>†</sup> to 10 (time(s))

<Redial Interval>

2 <sup>†</sup> to 99 (min.)

<Redial When Error Occurs>

<Off>

<On> <sup>†</sup>



<Menu> ▶ <Function Settings> ▶ <Send> ▶ <Fax Settings> ▶ <Auto Redial> ▶ Select <On> in <Use Auto Redial> ▶ Specify the settings ▶ <Apply> ▶

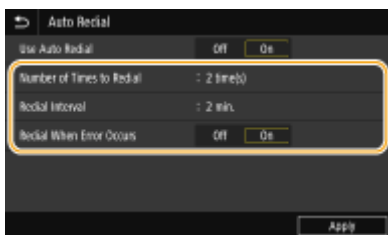

#### <Number of Times to Redial>

Specifies how many times the machine redials. Enter a number, and select <Apply>.

**<Redial Interval>**

Specifies the interval between redials. Enter a number for the interval, and select <Apply>.

**<Redial When Error Occurs>**

When set to <On>, specifies to redial when a transmission error occurs.

**<Check Dial Tone Before Send> \*2**

Select whether to check the dial tone before a fax number is dialed.

<Off> †  
<On>



<Menu> ▶ <Function Settings> ▶ <Send> ▶ <Fax Settings> ▶ <Check Dial Tone Before Send> ▶ <On> ▶ 

**<Set Line>**

Specify a fax number, unit name, and line type.

**<Register Unit Tel. Number>**

Register the fax number for the machine.  **Registering the Fax Number and Unit Name(P. 81)**

**<Register Unit Name>**

Register the name of a company or person (  **Registering the Fax Number and Unit Name(P. 81)** ). The registered name is sent as sender information to the destination (  **<TX Terminal ID>(P. 527)** ).

**<Select Line Type> \*2**

Select the telephone line type used for fax transmission.  **Connecting the Telephone Line(P. 83)**

<Pulse>  
<Tone> †

**<TX Start Speed>**

If it takes a long time to start sending a fax, such as when there is a poor connection, you can adjust the communication start speed downward incrementally.

<33600 bps> †  
<14400 bps>  
<9600 bps>  
<7200 bps>  
<4800 bps>  
<2400 bps>





<Menu> ▶ <Function Settings> ▶ <Send> ▶ <Fax Settings> ▶ <TX Start Speed> ▶ Select the communication start speed ▶ 

### <R-Key Setting>

If your machine is connected through a PBX (Private Branch Exchange), it is necessary to set the access method. If you set it to <PBX>, the <R> key will be displayed on the Fax Basic Features screen. If you assign an outside line access number to the <R> key, you can easily access the outside line.

<p>&lt;PSTN&gt; †</p> <p>&lt;PBX&gt; *2</p> <p>&lt;Prefix&gt;</p> <p>Prefix Code</p> <p>&lt;Hooking&gt; †</p>
---



<Menu> ▶ <Function Settings> ▶ <Send> ▶ <Fax Settings> ▶ <R-Key Setting> ▶ <PBX> ▶ Select <Prefix> or <Hooking> ▶ Enter an outside line access number if you select <Prefix> ▶ <Apply> ▶ 

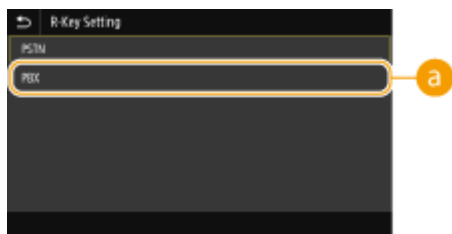

#### **a** <PBX>

Select <PBX> when you want the machine to be connected through a PBX (Private Branch Exchange). Set the function of the <R> key displayed on the Fax Basic Features screen to <Prefix> or <Hooking>. If you select <Prefix>, register the prefix code on the next screen. Enter the prefix code using the numeric keys, select <Pause>, and then select <Apply>. If you do not insert a pause, the prefix code is not registered.

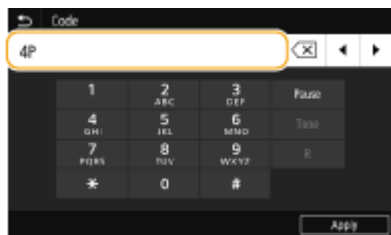

### <Archive TX Document> \*3

In addition to the destination specified when the fax is sent, you can specify whether faxed documents are also sent to a preset storage address for archiving. **▶ Saving a Copy of a Sent Original(P. 232)**

<p>&lt;Archive TX Document&gt;</p> <p>&lt;Off&gt; †</p> <p>&lt;On&gt;</p> <p>&lt;Archive Address&gt;</p>
--

### <Confirm Entered Fax Number>

Select whether to display the details of an entered coded dial number when it is selected as a destination. **▶ Confirming the Entered Fax Number(P. 405)**

<Off> †  
<On>

### <Allow Fax Driver TX>

Enable or disable PC faxing (sending faxes from a computer). ▶ **Restricting Fax Sending from a Computer(P. 405)**

<Off>  
<On> †

### <Use Addr. Book When On-Hook>

Make a setting so that you can perform fax transmission by entering a specific number before specifying a coded dial number or specifying a destination from the Address Book.

<Do Not Allow After Num. Key Use> †  
<Always Allow>



<Menu> ▶ <Function Settings> ▶ <Send> ▶ <Fax Settings> ▶ <Use Addr. Book When On-Hook> ▶ Select <Do Not Allow After Num. Key Use> or <Always Allow> ▶

## NOTE

- Transmission may be impossible if the entered number consists of too many digits.

### <Restrict Sequential Broadcast>



Select whether to prohibit sequential broadcasting, a feature that sends faxes to multiple destinations in succession. ▶ **Restricting Sequential Broadcasts(P. 405)**

<Off> †  
<On>

### <TX Terminal ID>

Specify settings for adding the sender information, including the fax number and the name of the machine, to the fax header. The recipient can check who sent the fax by looking at the added information.

**<Add TX Terminal ID>**  
<Off>  
<On> †  
  <Print Position>  
    <Inside Image Area>  
    <Outside Image Area> †  
  <Mark Number As>  
    <Fax> †  
    <Tel>

 <Menu> ▶ <Function Settings> ▶ <Send> ▶ <Fax Settings> ▶ <TX Terminal ID> ▶ Select <On> in <Add TX Terminal ID> ▶ Specify the settings ▶ <Apply> ▶ 

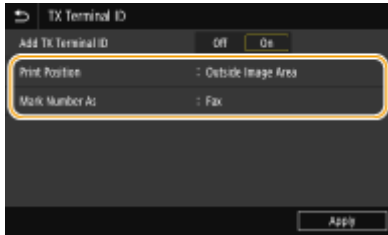

**<Print Position>**

Specifies the position to print the terminal ID information in the sent fax. Select <Inside Image Area> to print the information inside the image area, or <Outside Image Area> to print the information outside the image area.



**<Mark Number As>**

Adds the "Fax" or "Tel" mark in front of the fax number registered for the machine ( [▶ Registering the Fax Number and Unit Name\(P. 81\)](#) ). Select <Tel> to indicate that the notified number is a telephone number.

**<Auto Adjust VoIP Comm. Speed>**

When you want to perform a successful fax communication with a partner device or on a line with which errors tend to occur easily, you can use this function to reduce communication errors.

<Off>   
 <On>

 <Menu> ▶ <Function Settings> ▶ <Send> ▶ <Fax Settings> ▶ <Auto Adjust VoIP Comm. Speed> ▶ Select <Off> or <On> ▶ 

**NOTE**

- If you set the function to <On>, the communication speed may be slower.



## <Receive/Forward>

All the settings related to receiving faxes and e-mails are listed with descriptions. Default settings are marked with a dagger ( † ).

▶<Common Settings>(P. 529)

▶<I-Fax Settings>(P. 530)

▶<Fax Settings>(P. 531)

### NOTE

#### Asterisks (\*)

- Settings marked with "\*1" may not be displayed depending on the model you are using, options, or other setting items.
- Settings marked with "\*2" may be unavailable or vary or have different defaults depending on your country or region.
- Settings marked with "\*3" cannot be imported or exported.

### <Common Settings>

Specify operations that are to be performed when faxes are received in memory and when the amount remaining in the toner cartridge is low.

#### <Set Fax/I-Fax Inbox> \*1

Configure settings for receiving faxes in memory.

#### <Fax Memory Lock Settings>

Select whether to store received faxes without immediately printing them. Stored fax documents can be printed at any time by changing the setting to <Off>. ▶<Saving Received Documents into the Machine (Memory Reception)>(P. 234)

##### <Use Memory Lock>

<Off> †

<On>

##### <Use Fax Preview>

<Off> †

<On>

##### <Report Print>

<Off>

<On> †

##### <Set Memory Lock Time>

<Off> †

<On>

##### <Memory Lock Time>

<Memory Lock Start Time>

<Memory Lock End Time>

**<Continue Print. When Cart. Low>**

If receiving faxes when the amount remaining in the toner cartridges is low, the machine holds them in memory instead of printing. However, if this function is enabled, the machine continues printing. In addition to fax reception, this is true with I-Fax reception.

<Off> †  
<On>



<Menu> ▶ <Function Settings> ▶ <Receive/Forward> ▶ <Common Settings> ▶ <Continue Print. When Cart. Low> ▶ <On> ▶

**IMPORTANT**

- When this function is enabled, faxes may fade or blur. Because received documents are not stored, you need to ask the sender to resend the document.

**<I-Fax Settings>**

Configure settings to print received I-Fax documents.

**<Print on Both Sides>**

Specify settings for printing received documents on both sides of paper.

<Off> †  
<On>





<Menu> ▶ <Function Settings> ▶ <Receive/Forward> ▶ <I-Fax Settings> ▶ <Print on Both Sides> ▶ <On> ▶

**<RX Print Size>**

Specify the paper size to be used for printing.

<A4> †  
<LTR>  
<LGL>  
<FOOLSCAP/FOLIO>  
<OFICIO>  
<LETTER (Government)>  
<LEGAL (Government)>  
<LEGAL (India)>  
<FOOLSCAP (Australia)>  
<OFICIO (Brazil)>  
<OFICIO (Mexico)>



<Menu> ▶ <Function Settings> ▶ <Receive/Forward> ▶ <I-Fax Settings> ▶ <RX Print Size> ▶ Select the paper size ▶ 

## <Fax Settings> \*1

Configure settings for receiving and forwarding faxes.

### <Print on Both Sides>

Specify settings for printing received documents on both sides of paper.

<Off> +  
<On>





<Menu> ▶ <Function Settings> ▶ <Receive/Forward> ▶ <Fax Settings> ▶ <Print on Both Sides> ▶ <On> ▶ 

### <ECM RX>

Enable or disable error correction mode (ECM). ECM checks for fax data errors and corrects them. To reduce errors on sent faxes, see  <ECM TX>(P. 523) .

<Off>  
<On> +



<Menu> ▶ <Function Settings> ▶ <Receive/Forward> ▶ <Fax Settings> ▶ <ECM RX> ▶ <On> ▶ 

## NOTE

- ECM must be enabled on both the machine and the other fax device because error check is performed on both the sending and receiving devices.
- Even when ECM is enabled, errors may occur due to telephone line conditions.
- It may take a longer time than usual to process data when ECM is enabled because the error check and corrections are performed while the data is transmitted.

### <Incoming Ring> \*2

Specify settings for sounding a ring to notify you of incoming faxes. This feature is only available when <Auto> or <Fax/Tel (Auto Switch)> is selected for the receive mode. Specify how many times the incoming call rings when the machine receives a fax call. You can also disable the settings to prevent the incoming call from ringing.

<Use Incoming Ring>

<Off>  
 <On> †  
 <Number of Rings>  
 1 to 2 † to 99 (time(s))



<Menu> ▶ <Function Settings> ▶ <Receive/Forward> ▶ <Fax Settings> ▶ <Incoming Ring> ▶ Select <On> in <Use Incoming Ring> ▶ Enter the desired number in <Number of Rings> ▶ <Apply> ▶

## NOTE

- When <On> is specified, you need to connect your telephone or the optional handset to the machine beforehand.
- When <Off> is specified, the machine does not enter sleep mode.

### <Remote RX> \*2

Specify settings for receiving a fax by operating a telephone that is connected to the machine (Remote Reception). When a fax is sent to the machine, you can receive it just by picking up the handset of the telephone and entering a specific ID number by using the telephone. This feature can save you the trouble of going all the way to the machine. For instructions on how to use Remote Reception, see **Using a Telephone to Receive Faxes (Remote Reception)(P. 225)** .

<Use Remote RX>  
 <Off>  
 <On> †  
 <Remote RX ID>  
 00 to 25 † to 99



<Menu> ▶ <Function Settings> ▶ <Receive/Forward> ▶ <Fax Settings> ▶ <Remote RX> ▶ Select <On> in <Use Remote RX> ▶ Enter the ID number in <Remote RX ID> ▶ <Apply> ▶

### <Switch to Auto RX>

Specify settings for automatically receiving a fax after the machine has rung for a specified time period. This feature is only available when <Manual> is selected for the receive mode. By using this feature, faxes can be received even when no one is available to pick up the handset.

<Use Switch to Auto RX>  
 <Off> †  
 <On>  
 <Ring Time Until Auto RX>  
 1 to 15 † to 99 (sec.)



<Menu> ▶ <Function Settings> ▶ <Receive/Forward> ▶ <Fax Settings> ▶ <Switch to Auto RX> ▶ Select <On> in <Use Switch to Auto RX> ▶ Enter the desired number of seconds in <Ring Time Until Auto RX> ▶ <Apply> ▶

### <RX Start Speed>

If it takes a long time to start receiving a fax, such as when there is a poor connection, you can adjust the communication start speed downward incrementally.

- <33600 bps> †
- <14400 bps>
- <9600 bps>
- <7200 bps>
- <4800 bps>
- <2400 bps>



<Menu> ▶ <Function Settings> ▶ <Receive/Forward> ▶ <Fax Settings> ▶ <RX Start Speed> ▶ Select the communication start speed ▶

### <Use Reduce RX Size>

Specify settings for reducing the image size of a received document. You can select an automatic reduction ratio that reduces the received document to size of the loaded paper. You can also select a ratio from a list.

- <Use Reduce RX Size>**
- <Off>
- <On> †
- <Reduction Ratio>
  - <Auto> †
  - <97%>
  - <95%>
  - <90%>
  - <75%>
- <Reduction Direction>
  - <Vertical/Horizontal>
  - <Vertical Only> †



<Menu> ▶ <Function Settings> ▶ <Receive/Forward> ▶ <Fax Settings> ▶ <Use Reduce RX Size> ▶ Select <On> in <Use Reduce RX Size> ▶ Specify each setting item ▶ <Apply> ▶

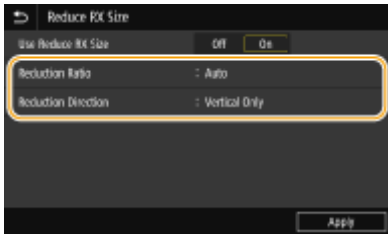

**<Reduction Ratio>**

<Auto> reduces the image by a ratio that is based on the size of the loaded paper. <97%>, <95%>, <90%>, or <75%> reduces the image by the corresponding ratio.

**<Reduction Direction>**

Select <Vertical/Horizontal> to reduce the image both vertically and horizontally. Select <Vertical Only> to reduce only vertically.

**<Print RX Page Footer>**

Select whether to print information, including date and time of reception and page numbers, on the bottom of received faxes.

<Off> +  
<On>



**<Forwarding Settings>**

Specify settings for forwarding faxes.

**<Forwarding Function> \*3**

Select whether to forward all the received fax documents to a specified destination. In addition to a fax number, you can also specify an e-mail address or a shared folder in a computer, etc. as the forwarding destination. **▶Forwarding the Received Documents Automatically(P. 236)**

**<Use Forwarding Function>**  
<Off> +  
<On>  
<Forwarding Destination>

**<Print Images>**

Select whether to print forwarded fax documents. You can set the machine to print forwarded documents only when an error occurs. **▶Printing Documents to be Forwarded(P. 236)**

<Off>  
<On> +  
<Only When Error Occurs>

**<Store Images in Memory>**

Select whether to store fax documents in memory when they are not successfully forwarded. You can resend or print the documents later as necessary. **▶Printing/Resending/Deleting Documents that Failed to be Forwarded(P. 236)**

<Off> +

<Only When Error Occurs>

## <Store/Access Files>

261J-091

All the settings related to saving the scanned document to a USB memory device or printing stored files are listed with descriptions. Default settings are marked with a dagger ( †).

▶<Common Settings>(P. 536)

▶<Memory Media Settings>(P. 541)

### NOTE

#### Asterisks (\*)

- Settings marked with an asterisk (\*) may not be displayed depending on the model you are using, options, or other setting items.

## <Common Settings>

Change the settings for file saving or memory media print.

### <Scan and Store Settings>

Configure settings for saving the scanned document to a USB memory device.

### <USB Memory Settings>

You can change the settings used when data is saved to a USB memory device.

#### <Change Default Settings (USB Memory)>

You can change the default settings used for saving scanned originals to a USB memory device. The selected settings are used as the default settings when scanning originals. ▶<Changing the Default Settings for Functions>(P. 170)

#### <Scan Size>

<A4> †

<A5R>

<A6>

<B5>

<LTR>

<LGL>

<STMT>

<EXEC>

<FOOLSCAP/FOLIO>

<OFICIO>

<LETTER (Government)>

<LEGAL (Government)>

<LEGAL (India)>

<FOOLSCAP (Australia)>

<OFICIO (Brazil)>

<OFICIO (Mexico)>

#### <File Format>

<PDF> †



<PDF (Compact)>  
 <PDF (Compact/OCR)>  
 <PDF (OCR)>  
 <Set PDF Details>  
   <PDF>/<PDF (Compact)>/<PDF (Compact/OCR)>/<PDF (OCR)>  
     <Encryption>  
       <None> †  
       <Acrobat 7.0 or Later/128-bit AES>  
       <Acrobat 9.0 or Equivalent/256-bit AES>\*  
       <Acrobat 10.0 or Equivalent/256-bit AES>\*  
     <Digital Signatures>  
       <None> †  
       <Top Left>  
     <Divide into Pages>  
       <Off> †  
       <On>  
 <JPEG>  
 <TIFF>  
 <Set TIFF Details>  
   <Divide into Pages>  
     <Off> †  
     <On>  
  
**<Density>**  
 Nine Levels  
  
**<Original Orientation>**  
 <Portrait> †  
 <Landscape>  
  
**<Original Type>**  
 <Text>  
 <Text/Photo> †  
 <Photo>  
  
**<2-Sided Original>**  
 <Off> †  
 <Book Type>  
 <Calendar Type>  
  
**<Sharpness>**  
 Seven Levels  
  
**<Data Size>**  
 <Small: Memory Priority>  
 <Standard> †  
 <Large: Image Quality Priority>

**<Access Stored Files Settings>**

You can change the settings to print files in a USB memory device and the method for displaying them.

**<Change Default Settings (Memory Media Print)>**

You can change the default settings associated with memory media print. The settings configured here are used as the default settings of the memory media print function. **▶ Changing the Default Settings for Functions(P. 170)**

**<Paper>**

<Multi-Purpose Tray>

<Drawer 1> †

<Drawer 2>\*

<Drawer 3>\*

<Drawer 4>\*

**<Number of Copies>**

1 † to 999

**<2-Sided Printing>**

<Off> †

<Book Type>

<Calendar Type>

**<Print Quality>**

<Density>\*

17 Levels

<Fine Adjust>

<High>/<Medium>/<Low>

17 levels

<Toner Save>

<Off> †

<On>

<Image Refinement>

<Off>

<On> †

<Resolution>

<1200 dpi>

<600 dpi> †

**<Set JPEG/TIFF Details>**

<Brightness>

Five Levels

<N on 1>

<Off> †

<2 on 1>

<4 on 1>

<Original Type>

<Photo Priority> †

<Text Priority>

<Halftones>

<ul style="list-style-type: none"> <li>&lt;Gradation&gt;</li> <li>&lt;Error Diffusion&gt; †</li> </ul>
<p><b>&lt; Set PDF Details&gt;</b></p> <ul style="list-style-type: none"> <li>&lt;N on 1&gt;</li> <li>&lt;Off&gt; †</li> <li>&lt;2 on 1&gt;</li> <li>&lt;4 on 1&gt;</li> <li>&lt;6 on 1&gt;</li> <li>&lt;8 on 1&gt;</li> <li>&lt;9 on 1&gt;</li> <li>&lt;16 on 1&gt;</li> <li>&lt;Print Range&gt;</li> <li>&lt;All Pages&gt; †</li> <li>&lt;Specified Pages&gt;</li> <li>&lt;Enlarge/Reduce to Fit Paper Size&gt;</li> <li>&lt;Off&gt; †</li> <li>&lt;On&gt;</li> <li>&lt;Enlarge Print Area&gt;</li> <li>&lt;Off&gt; †</li> <li>&lt;On&gt;</li> <li>&lt;Print Comments&gt;</li> <li>&lt;Off&gt;</li> <li>&lt;Auto&gt; †</li> <li>&lt;Other Settings&gt;</li> <li>&lt;Halftones&gt;</li> <li>&lt;Resolution/Gradation&gt;</li> <li>&lt;Text&gt;</li> <li>&lt;Resolution&gt; †</li> <li>&lt;Gradation&gt;</li> <li>&lt;High Resolution&gt;</li> <li>&lt;Graphics&gt;</li> <li>&lt;Resolution&gt; †</li> <li>&lt;Gradation&gt;</li> <li>&lt;High Resolution&gt;</li> <li>&lt;Image&gt;</li> <li>&lt;Resolution&gt; †</li> <li>&lt;Gradation&gt;</li> <li>&lt;High Resolution&gt;</li> <li>&lt;Grayscale Conversion&gt;</li> <li>&lt;sRGB&gt;</li> <li>&lt;NTSC&gt; †</li> <li>&lt;Uniform RGB&gt;</li> </ul>

**<Default Display Settings>**

Select Preview/Details as the method for displaying files in a USB memory device.

<ul style="list-style-type: none"> <li>&lt;Preview&gt;</li> <li>&lt;Details&gt; †</li> </ul>
--



<Menu> ▶ <Function Settings> ▶ <Store/Access Files> ▶ <Common Settings> ▶ <Access Stored Files Settings> ▶ <Default Display Settings> ▶ Select the method for displaying ▶ 

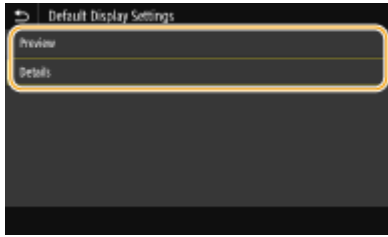

**<Preview>**

Displays a preview image.

**<Details>**

Displays file names and dates in list form.

**<File Sort Default Settings>**

Select whether to display files in a USB memory device in ascending or descending order of file name or date.

- <Name (Ascending)> †
- <Name (Descending)>
- <Date/Time (Ascending)>
- <Date/Time (Descending)>





<Menu> ▶ <Function Settings> ▶ <Store/Access Files> ▶ <Common Settings> ▶ <Access Stored Files Settings> ▶ <File Sort Default Settings> ▶ Select the order of files that are displayed ▶ 

**<File Name Display Format>**

Select whether to display short or long text for file names that are stored in a USB memory device.

- <Short File Name>
- <Long File Name> †



<Menu> ▶ <Function Settings> ▶ <Store/Access Files> ▶ <Common Settings> ▶ <Access Stored Files Settings> ▶ <File Name Display Format> ▶ Select <Short File Name> or <Long File Name> ▶ 



**<Short File Name>**

Shortens a file name to as few as eight characters. To distinguish files that have similar names, numbers such as "~1" or "~2" are added at the end of the file names.

**<Long File Name>**

Displays a file name up to 40 characters.

**NOTE:**

- The number of characters described above does not include the characters in file extensions, such as ".jpg."

## <Memory Media Settings>

Specify whether to enable or disable the functions of a USB memory device.

**<Use Scan Function>**

Select whether to permit storing scanned originals into a USB memory device. **▶ Restricting the Scan to USB Function(P. 408)**

<Off> +  
<On>

**<Use Print Function>**

Select whether to permit printing data from a USB memory device when it is attached to the machine. **▶ Restricting the USB Print Function(P. 408)**

<Off> +  
<On>

## <Secure Print>

---

261J-092

Specify whether to enable or disable Secure Print ( **▶ Printing via Secure Print(P. 262)** ). Default settings are marked with a dagger ( † ).

**<Use Secure Print>**

&lt;Off&gt;

&lt;On&gt; †

## &lt;Restrict Printer Jobs&gt;

&lt;Off&gt; †

&lt;On&gt;

## &lt;Secure Print Deletion Time&gt;

10 to 30 † to 240 (min.)

## <Set Destination>

---

261J-093

All the settings related to the address book are listed with descriptions.

### <Address Book PIN>

Specify a PIN and require entering it to add new entries to or edit existing entries in the Address Book. **▶ Restricting Use of the Address Book(P. 401)**

## <Management Settings>

---

261J-094

Item	Description
▶<User Management>(P. 545)	You can configure the settings for managing users of the machine.
▶<Device Management>(P. 546)	You can manage information about the hardware and operations, as well as various data required when using the machine functions.
▶<License/Other>(P. 550)	You can configure the settings related to the Remote UI and software available for the machine.
▶<Data Management>(P. 552)	You can configure settings to utilize data such as machine settings data or perform data initialization.
▶<Security Settings>(P. 554)	You can configure the settings related to the user authentication function, password, and encryption.
<Initialize All Data/Settings>	Restores all data including logs and setting values to their default settings. ▶ <b>Initializing All Data/Settings(P. 443)</b>



## <User Management>

261J-095

All the settings related to user management of the machine are listed with descriptions. Default settings are marked with a dagger (†).

▶<System Manager Information Settings>(P. 545)

▶<Department ID Management>(P. 545)

### <System Manager Information Settings>

Specify the ID or PIN exclusively for Administrators who have access privileges to <Network> and <Management Settings>. ID is <System Manager ID> and PIN is <System Manager PIN>. You can also register the name of an Administrator. ▶<Setting the System Manager ID and PIN>(P. 349)

#### <System Manager ID and PIN>

Enter a number for the System Manager ID and PIN.

<System Manager ID>  
<System Manager PIN>

#### <System Manager Name>

Enter alphanumeric characters for the name of an Administrator.

### <Department ID Management>

Set the Department ID Management function to control access to the machine by using multiple IDs. ▶<Setting the Department ID Management>(P. 351)

<Department ID Management>  
<Off> †  
<On>  
  <Allow Print Jobs (Unknown IDs)>  
    <Off>  
    <On> †  
  <Allow Scan Jobs (Unknown IDs)>  
    <Off>  
    <On> †

## NOTE

- You can select <Register/Edit> to register department IDs and edit the settings of the registered IDs.
- You can select <Count Mngt.> to check the total number of pages for jobs that have been executed to date on a department ID basis.

## <Device Management>

261J-096

All the settings related to management of information for the hardware and operations, as well as about management of data required when using the machine functions are listed with descriptions. Default settings are marked with a dagger ( †).

- ▶<Device Information Settings>(P. 546)
- ▶<Select Country/Region>(P. 546)
- ▶<Display Job Log>(P. 547)
- ▶<Use NFC>(P. 547)
- ▶<Display Consumables Information (RUI/Toner Status)>(P. 547)
- ▶<Scan w/ Canon PRINT Business>(P. 548)
- ▶<Notify to Check Paper Settings>(P. 548)

### NOTE

#### Asterisks (\*)

- Settings marked with "\*1" cannot be imported or exported.
- Settings marked with "\*2" may be unavailable or vary or have different defaults depending on your country or region.
- Settings marked with "\*3" may not be displayed depending on the model you are using, options, or other setting items.

## <Device Information Settings>

Enter alphanumeric characters for the name and the installation location to identify the machine.

<Device Name>  
<Location>



<Menu> ▶ <Management Settings> ▶ <Device Management> ▶ <Device Information Settings> ▶ Select <Device Name> or <Location> ▶ Enter the device name or location ( ▶ **Entering Text(P. 130)** ) ▶ <Apply> ▶

## <Select Country/Region> \*1 \*2

Specify the country or region where the machine is used. The default setting may vary depending on the setting selected at initial power-on.

<Austria (AT)>	<Netherlands (NL)>
<Belarus (BY)>	<Norway (NO)>
<Belgium (BE)>	<Poland (PL)>
<Czech Republic (CZ)>	<Portugal (PT)>
<Denmark (DK)>	<Russia (RU)>
<Egypt (EG)>	<Saudi Arabia (SA)>

<Finland (FI)>	<Slovenia (SI)>
<France (FR)>	<South Africa (ZA)>
<Germany (DE)>	<Spain (ES)>
<Greece (GR)>	<Sweden (SE)>
<Hungary (HU)>	<Switzerland (CH)>
<Ireland (IE)>	<Ukraine (UA)>
<Italy (IT)>	<Great Britain (GB)> †
<Jordan (JO)>	<Other>
<Luxembourg (LU)>	



<Menu> ▶ <Management Settings> ▶ <Device Management> ▶ <Select Country/Region> ▶ Select a country or region ▶ 

### <Display Job Log>

Select whether to display the copying, printing, faxing, and scanning logs on the display of the machine and in the Communication Management Report.

<Off>  
<On> †



<Menu> ▶ <Management Settings> ▶ <Device Management> ▶ <Display Job Log> ▶ Select <Off> or <On> ▶ <OK> ▶ Restart the machine

### <Use NFC> \*3

Select whether to allow printing by touching an NFC-capable mobile device to the NFC mark on the machine's operation panel.

<Off>  
<On> †



<Menu> ▶ <Management Settings> ▶ <Device Management> ▶ <Use NFC> ▶ Select <Off> or <On> ▶ Restart the machine

### <Display Consumables Information (RUI/Toner Status)>

Set whether to display a button in the Remote UI or Toner Status for accessing the Web site for purchasing toner cartridges. Also set whether to use Toner Status.

<Displ. Cnsmbls. Purch. Btn.(RUI)>

<Off>  
 <On> †

**<Toner Status Settings>**  
 <Off>  
 <On> †

    <Displ. Consmbls. Purchase Btn.>  
         <Off>  
         <On> †



<Menu> ▶ <Management Settings> ▶ <Device Management> ▶ <Display Consumables Information (RUI/Toner Status)> ▶ Specify the settings ▶ 

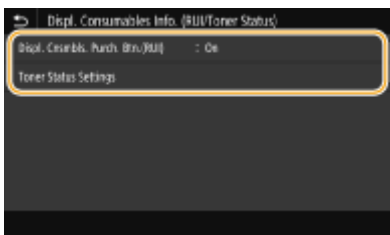

**<Displ. Cnsmbls. Purch. Btn.(RUI)>**

Select <Off> to prevent a button that accesses sites for purchasing toner cartridges from being displayed in the Remote UI.

**<Toner Status Settings>**

If you do not want to use Toner Status, select <Off>. To prevent a button that accesses sites for purchasing toner cartridges from being displayed in Toner Status, select <On> and then <Off>.

**<Scan w/ Canon PRINT Business>**

Select whether to allow scanning from a mobile device using the Canon PRINT Business application.

<Off>  
 <On> †



<Menu> ▶ <Management Settings> ▶ <Device Management> ▶ <Scan w/ Canon PRINT Business> ▶ Select <Off> or <On> ▶ <OK> ▶ Restart the machine

**<Notify to Check Paper Settings>**

Specify whether to display a message prompting you to check paper settings when loading the paper drawer into the machine.

<Off>  
 <On> †



<Menu> ▶ <Management Settings> ▶ <Device Management> ▶ <Notify to Check Paper Settings> ▶  
Select <Off> or <On> ▶ <OK> ▶ Restart the machine

## <License/Other>

All the settings related to the software and system options available for the machine as well as about Register License are listed with descriptions. Default settings are marked with a dagger ( † ).

- ▶<Register License>(P. 550)
- ▶<Remote UI Settings>(P. 550)
- ▶<Update Firmware>(P. 551)

### NOTE

#### Asterisks (\*)

- Settings marked with an asterisk (\*) cannot be imported or exported.

### <Register License> \*

Enter the license key for a system option that can be used on the machine. ▶<License Registration>(P. 690)

### <Remote UI Settings> \*

Configure settings for using the Remote UI. Using the Remote UI allows you to configure machine settings from a Web browser.

#### <Remote UI>

Select whether to use the Remote UI ( ▶<Disabling Remote UI>(P. 411) ). When using Remote UI, you can also specify whether to use the TLS encrypted communication ( ▶<Configuring the Key and Certificate for TLS>(P. 376) ).

##### <Use Remote UI>

<Off>

<On> †

<Use TLS>

<Off> †

<On>



<Menu> ▶ <Management Settings> ▶ <License/Other> ▶ <Remote UI Settings> ▶ <Remote UI>  
 ▶ Select <On> in <Use Remote UI> ▶ Select <Off> or <On> in <Use TLS> ▶  
 <Apply> ▶ <OK> ▶ Restart the machine

#### <Restrict Access>

Specify so that entry of a PIN is required for access to the Remote UI. Set a PIN of up to 7 digits. All users use a common PIN. ▶<Setting a Remote UI PIN>(P. 357)

<Off> †

<On>  
<Remote UI Access PIN>



<Menu> ▶ <Management Settings> ▶ <License/Other> ▶ <Remote UI Settings> ▶ <Restrict Access> ▶ <On> ▶ Enter the PIN ▶ <Apply> ▶ Enter the PIN (Confirm) ▶ <Apply> 

## <Update Firmware> \*

Select how to install the firmware update according to the environment of the machine.  **Updating the Firmware(P. 440)**

<Via PC>  
<Via Internet>  
<Version Information>

## <Data Management>

261J-098

The settings for utilizing the machine settings and for initializing data are listed with descriptions. Default settings are marked with a dagger (†).

- ▶<Import/Export>(P. 552)
- ▶<Enable Prod. Ext'd Survey Prog.>(P. 553)
- ▶<Initialize Key and Certificate>(P. 553)
- ▶<Initialize Address Book>(P. 553)
- ▶<Initialize Menu>(P. 553)

### NOTE

#### Asterisks (\*)

- Settings marked with an asterisk (\*) cannot be imported or exported.

### <Import/Export> \*

You can use a USB memory device to import and export data in the Address Book and various settings of the machine. For more information about the available USB memory devices and how to insert/remove the USB memory device, see

- ▶<Using a USB Memory Device>(P. 184) .

<Import>  
<Export>

#### Import



<Menu> ▶ <Management Settings> ▶ <Data Management> ▶ <Import/Export> ▶ <Import>  
▶ <Yes> ▶ Enter the password ▶ <Apply>

#### Export



<Menu> ▶ <Management Settings> ▶ <Data Management> ▶ <Import/Export> ▶ <Export>  
▶ Enter the password ▶ <Apply> ▶ Enter the password (Confirm) ▶ <Apply>

### NOTE

#### If the <Address Book PIN> screen appears

- If a PIN has been set for the Address Book, the <Address Book PIN> screen appears during importing/exporting. Enter the Address Book PIN and select <Apply>. Select <Skip> to cancel Address Book data importing/exporting.

#### When import is executed

- The machine automatically restarts after the import process has finished.



## <Enable Prod. Ext'd Survey Prog.>

Enable or disable the Product Extended Survey Program (a program for the machine usage survey).

<Off>  
<On> †



<Menu> ▶ <Management Settings> ▶ <Data Management> ▶ <Enable Prod. Ext'd Survey Prog.> ▶ Select <Off> or <On> ▶ <OK> ▶ Restart the machine

## <Initialize Key and Certificate> \*

Select to restore [Key and Certificate Settings] and [CA Certificate Settings] to the factory defaults. ▶ **Initializing Key and Certificate(P. 442)**

## <Initialize Address Book> \*

Select to restore the Address Book settings to the factory defaults. ▶ **Initializing Address Book(P. 443)**

## <Initialize Menu> \*

Select to restore the settings listed below to the factory defaults. You can restore all the settings listed below at once, or you can restore individual settings separately. ▶ **Initializing Menu(P. 442)**

<Preferences>  
<Adjustment/Maintenance>  
<Function Settings>  
<Set Destination>  
<Management Settings>  
<Initialize All>

## <Security Settings>

All the settings related to the authentication function and encryption are listed with descriptions. Default Settings are marked with a dagger (†).

▶<Authentication/Password Settings>(P. 554)

▶<Encryption Settings>(P. 554)

### <Authentication/Password Settings>

You can reinforce the security of the authentication function.

#### <Authentication Function Settings>

Configure the security functions for user authentication.

#### <Lockout>

When a user has failed user authentication, specify whether to disable the user from temporarily logging in to the machine (lockout). When <On> is selected, specify how many consecutive times failures are permitted before lockout is activated and also the time required before a user can log in again after lockout.

<Enable Lockout>  
 <Off> †  
 <On>  
 <Lockout Threshold>  
 1 † to 10 (time(s))  
 <Lockout Period>  
 1 † to 60 (min.)



<Menu> ▶ <Management Settings> ▶ <Security Settings> ▶ <Authentication/Password Settings>  
 ▶ <Authentication Function Settings> ▶ <Lockout> ▶ Select <On> in <Enable Lockout> ▶ Specify  
 each setting item ▶ <Apply> ▶ <OK> ▶ Restart the machine

### IMPORTANT:

- This option is not applied to login using the department ID.

### <Encryption Settings>

Configure a setting for disabling a weak encryption or the key and certification using a weak encryption.

<Prohibit Use of Weak Encrypt.>  
 <Off> †  
 <On>  
 <Prohibit Weak Encrypt. Key/Cert.>  
 <Off> †  
 <On>



<Menu> ▶ <Management Settings> ▶ <Security Settings> ▶ <Encryption Settings> ▶ Select <On> in <Prohibit Use of Weak Encrypt.> ▶ Select <Off> or <On> in <Prohibit Weak Encryp. Key/Cert.> ▶ <Apply> ▶ <OK> ▶ Restart the machine

# Maintenance

<b>Maintenance</b> .....	557
<b>Regular Cleaning</b> .....	559
Cleaning the Exterior .....	560
Cleaning the Platen Glass .....	561
Cleaning the Feeder .....	562
Cleaning the Fixing Assembly .....	565
<b>Replacing the Toner Cartridge</b> .....	566
<b>Checking the Remaining Amount of Consumables</b> .....	569
<b>Relocating the Machine</b> .....	570
<b>Adjusting Image Quality</b> .....	572
Adjusting the Gradation and Density for Copy Jobs .....	573
Adjusting Values for Text Color Reproducibility .....	575
Adjusting Print Density .....	577
Adjusting Print Position .....	578
<b>Viewing the Counter Value</b> .....	580
<b>Printing Reports and Lists</b> .....	581
<b>Consumables</b> .....	586

# Maintenance

261J-09A

This chapter describes upkeep of the machine, including how to clean the machine and adjustment of print quality.

## ■ Basic Cleaning



▶Regular Cleaning(P. 559)

## ■ Replacing Consumables

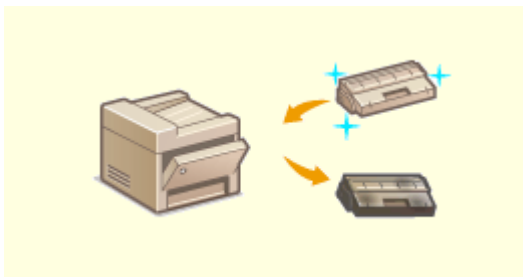

▶Replacing the Toner Cartridge(P. 566)



▶Checking the Remaining Amount of Consumables(P. 569)



▶Consumables(P. 586)

## ■ Adjusting and Managing the Machine

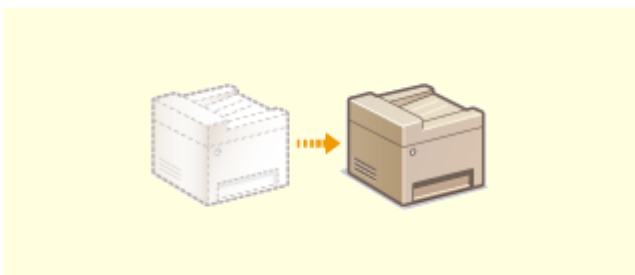

▶ **Relocating the Machine(P. 570)**

▶ **Adjusting Image Quality(P. 572)**

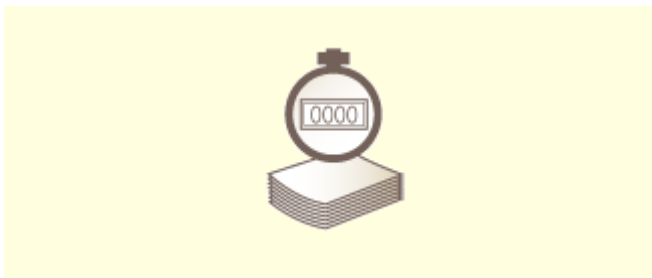

▶ **Viewing the Counter Value(P. 580)**

▶ **Printing Reports and Lists(P. 581)**

## Regular Cleaning

---

Regularly clean the machine to prevent deterioration in printing quality and to ensure that you use it safely and easily.

### Where to Clean

---

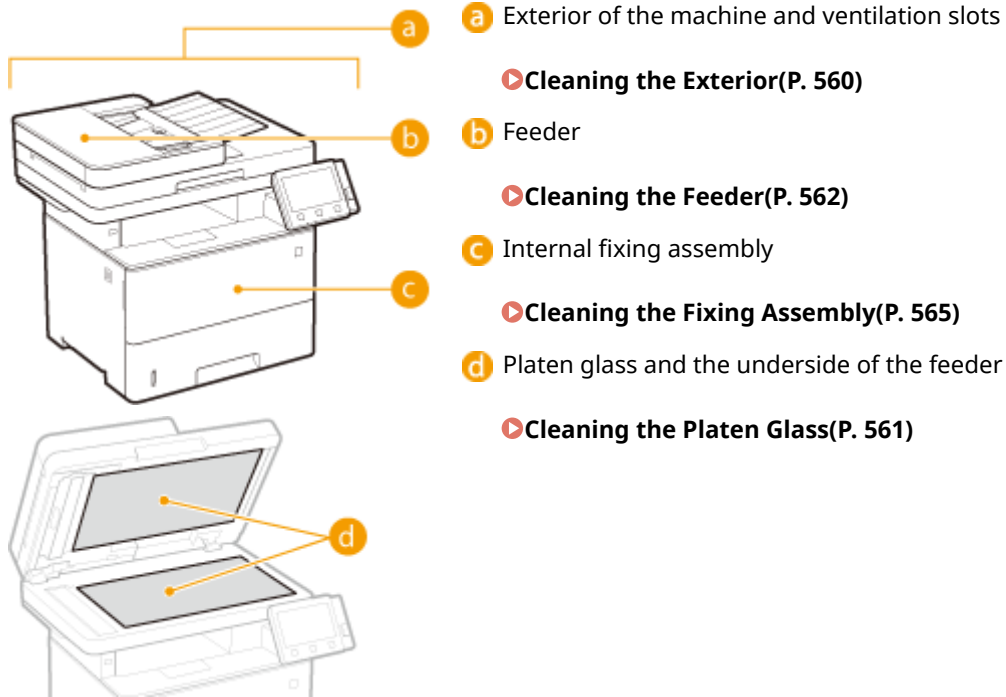

## Cleaning the Exterior

---

261J-09E

Regularly wipe the exterior of the machine, especially around the ventilation slots, to keep the machine in good condition.

### 1 Turn OFF the machine, and unplug the power cord from the AC power outlet.

- When you turn OFF the machine, data that is waiting to be printed is deleted. Fax documents that were received by using the Memory Reception function, faxes that are waiting to be sent, and reports that are automatically printed after sending and receiving faxes are not deleted.

### 2 Clean the exterior of the machine and the ventilation slots.

- Use a soft, well-wrung-out cloth dampened with water or a mild detergent diluted with water.
- To locate the ventilation slots, see [▶Front Side\(P. 106\)](#) .

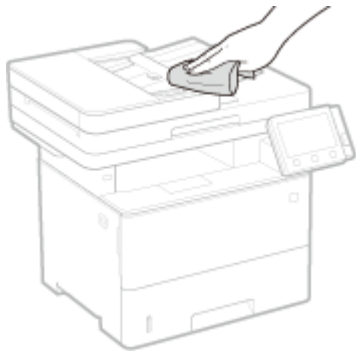

### 3 Wait for the exterior of machine to dry completely.

### 4 Reconnect the power cord and turn ON the machine.



# Cleaning the Platen Glass

---

261J-09F

Regularly wipe off the dust from the platen glass and the underside of the feeder to prevent smudges to be printed on originals or printouts.

## 1 Turn OFF the machine, and unplug the power cord from the AC power outlet.

- Turning the printer OFF erases any queued print data. Data such as documents received and held in memory, documents waiting to be sent, and reports that are automatically printed after sending or receiving faxes are not deleted.

## 2 Open the feeder.

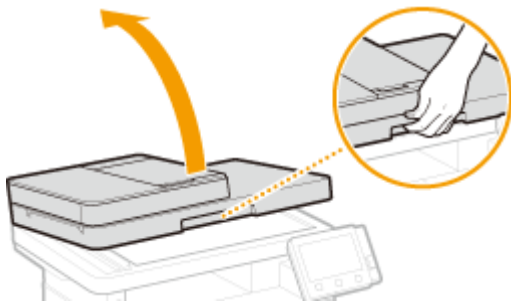

## 3 Clean the platen glass and the underside of the feeder.

- Clean the areas with a cloth dampened with water. Then, wipe the area with a soft, dry cloth.

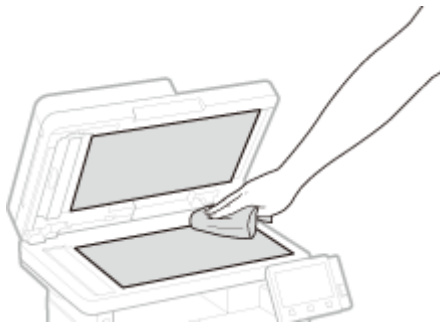

## 4 Wait for the cleaned area to dry completely.

## 5 Gently close the feeder.

## 6 Reconnect the power cord and turn ON the machine.

# Cleaning the Feeder

261J-09H

Graphite powder or dust on the rollers inside the feeder or on the document feed scanning area may cause smudges to appear on printouts. If this occurs or if a paper jam occurs frequently, clean the feeder. If the problem persists after cleaning the feeder, perform automatic feeder cleaning.

▶ **Cleaning the Feeder(P. 562)**

▶ **Automatic Feeder Cleaning(P. 564)**

## Cleaning the Feeder

### 1 Turn off the machine and unplug it from the power outlet.

- Turning the printer OFF erases any queued print data. Data such as documents received and held in memory, documents waiting to be sent, and reports that are automatically printed after sending or receiving faxes are not deleted.

### 2 Open the original supply tray.



### 3 Open the feeder cover.



### 4 Wipe the rollers in the feeder.

- Wipe the rollers with a cloth that has been moistened with water and wrung out. Then wipe with a dry cloth.

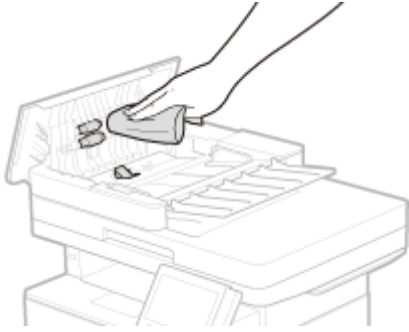

**IMPORTANT:**

- If the rollers and surrounding areas are very dirty, clean them out. To do this, wet a cloth with water and wring it out well, then wipe the dirty areas. Afterwards, wipe the areas with a soft and dry cloth.



**5** Close the feeder cover and original supply tray.

**6** Open the feeder.

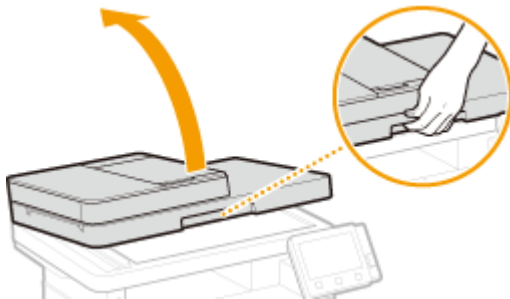

**7** Wipe the document feed scanning area.

- Wipe with a cloth that has been moistened with water and wrung out, and then wipe with a dry cloth.



**8** Wait for the cleaned area to dry completely.

**9 Gently close the feeder.**

**10 Plug the machine back into the power outlet and switch it on.**

## Automatic Feeder Cleaning

Automatic feeder cleaning uses paper loaded in the feeder. Set 10 sheets of plain A4 or US Letter size paper in the feeder before starting automatic cleaning. ▶ **Placing Originals(P. 134)**

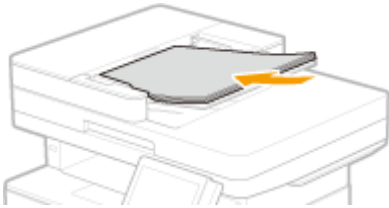

**1 Select <Menu> in the Home screen. ▶ Home Screen(P. 121)**

**2 Select <Adjustment/Maintenance> ▶ <Maintenance>.**

**3 Select <Clean Feeder>.**

**4 Select <Start>.**

▢ Cleaning starts. When a message appears notifying that cleaning is complete, press  to return to the Home screen.



# Cleaning the Fixing Assembly



261J-09J

Dirt may adhere to the fixing assembly inside the machine and cause black streaks to appear on printouts. To clean the fixing assembly, perform the following procedure. Note that you cannot clean the fixing assembly when the machine has documents waiting to be printed. To clean the fixing assembly, you need plain A4 or Letter size paper. Set the paper in the paper drawer or multi-purpose tray before performing the following procedure.  **Loading Paper(P. 138)**

## NOTE

- Cleaning consumes the toner cartridge. Make sure that there is sufficient toner cartridge remaining beforehand.  **Checking the Remaining Amount of Consumables(P. 569)**

- 1** Select <Menu> in the Home screen.  **Home Screen(P. 121)**
- 2** Select <Adjustment/Maintenance>  <Maintenance>.
- 3** Select <Clean Fixing Assembly>.
- 4** Check that the size and type of paper displayed on the screen is loaded in the machine, and select <OK>
- 5** Select <Start>.

 Cleaning starts. When a message appears notifying that cleaning is complete, press  to return to the Home screen.

# Replacing the Toner Cartridge

261J-09K

The machine displays a message when the amount remaining in the toner cartridge is low. Note that the print quality may suffer if you continue printing without resolving this issue. You can check the amount remaining in the toner cartridges on the display ( [▶Checking the Remaining Amount of Consumables\(P. 569\)](#) ).

- ▶[When a Message Appear\(P. 566\)](#)
- ▶[When Printouts are Poor in Quality\(P. 567\)](#)
- ▶[Procedure for Replacing the Toner Cartridge\(P. 567\)](#)

## When a Message Appear

The message that is displayed depends on the amount remaining in the toner cartridges. Depending on which message is displayed, prepare a new toner cartridge ( [▶Consumables\(P. 586\)](#) ) or replace the current toner cartridge with a new one ( [▶Procedure for Replacing the Toner Cartridge\(P. 567\)](#) ).

### <Prepare cartridge.>

This message notifies you that a toner cartridge needs to be replaced soon. Make sure that you have a replacement toner cartridge ready. Replace the toner cartridge if you see this message before you start to print a large job.

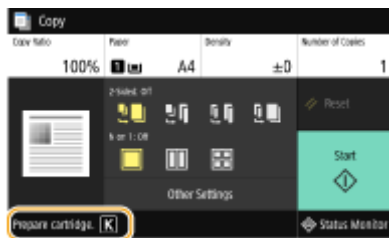

## NOTE

### When this message is displayed

- When copying or printing, you can continue printing the original.
- If a message is displayed when the machine is receiving a fax or automatic report output is set, received faxes and reports will be stored in memory so that they do not appear faded after they are printed. To continue printing even if the amount remaining in toner cartridge is running low, set <Continue Print. When Cart. Low> to <On>. [▶<Continue Print. When Cart. Low>\(P. 530\)](#)

### Specify when this message is displayed

- You can set any value as the percentage of the amount remaining in the toner cartridge that triggers this message. [▶<Display Timing for Cart. Prep.>\(P. 450\)](#)

### <End of cartridge lifetime.>

This message notifies you that a toner cartridge has reached the end of its lifetime. It is recommended that you replace the cartridge with a new one. You can continue printing, but the print quality cannot be guaranteed.

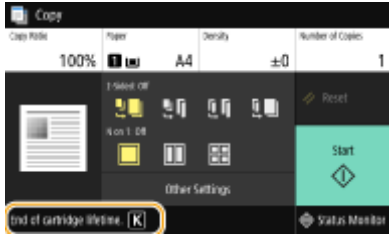

## When Printouts are Poor in Quality

If your printouts begin to show any of the following features, one of your toner cartridges is consumed. Replace the nearly empty toner cartridge even if no message is displayed. **Procedure for Replacing the Toner Cartridge (P. 567)**

Streaks Appear/Printing is Uneven



Partially faded



Uneven density



White Spots Appear



Toner smudges and splatters appear



Blank space of originals becomes grayish in printouts



## Procedure for Replacing the Toner Cartridge

Follow the procedure below to replace the toner cartridge.

**1** Open the front cover.

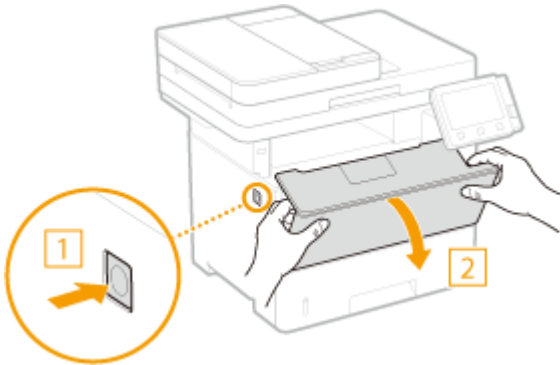

**2** Remove the toner cartridge.

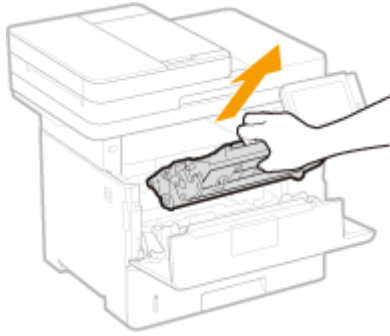

**3** Remove the replacement toner cartridge from the protective case.

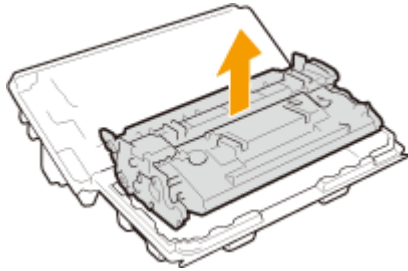

**4** Shake the toner cartridge 5 or 6 times as shown below to evenly distribute the toner inside the cartridge.

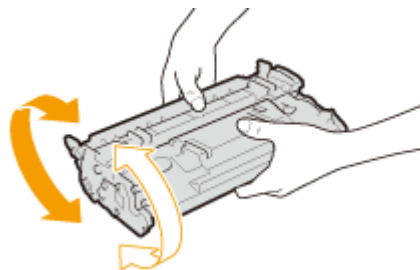

**5** Install the toner cartridge.

- Fully push it in until it cannot go any further.

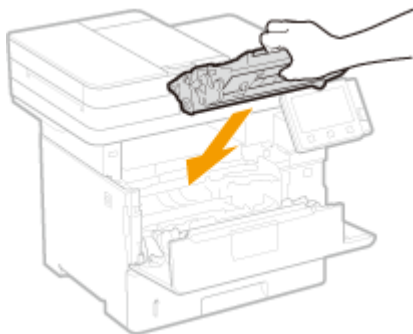

**6** Close the front cover.

## LINKS

---

• [Consumables\(P. 586\)](#)



## Checking the Remaining Amount of Consumables

---

261J-09L

Use the procedure below to check the amount remaining in the toner cartridges. It is particularly important to check whether you need to have a new toner cartridge ready before starting a large print job.



<Status Monitor> ▶ <Device Information> ▶ <Cartridge Information> ▶ Checking the amount remaining in the toner cartridges ▶ 

### NOTE

- The displayed amount remaining in a toner cartridge can be used only as a guide and may differ from the actual amount.

### LINKS

---

▶ [Replacing the Toner Cartridge\(P. 566\)](#)

▶ [Consumables\(P. 586\)](#)

# Relocating the Machine

The machine is heavy. Make sure to follow the procedure below when moving the machine to avoid injury.

## 1 Turn OFF the machine and computer.

- When you turn OFF the machine, data that is waiting to be printed is deleted. Fax documents that were received by using the Memory Reception function, faxes that are waiting to be sent, and reports that are automatically printed after sending and receiving faxes are not deleted.

## 2 Disconnect the cables and cord from the machine in numerical order as in the illustration below.

- Whether the cables with "\*" are connected depends on your environment.
- If an optional handset is mounted on the machine, remove the handset from its mounting.

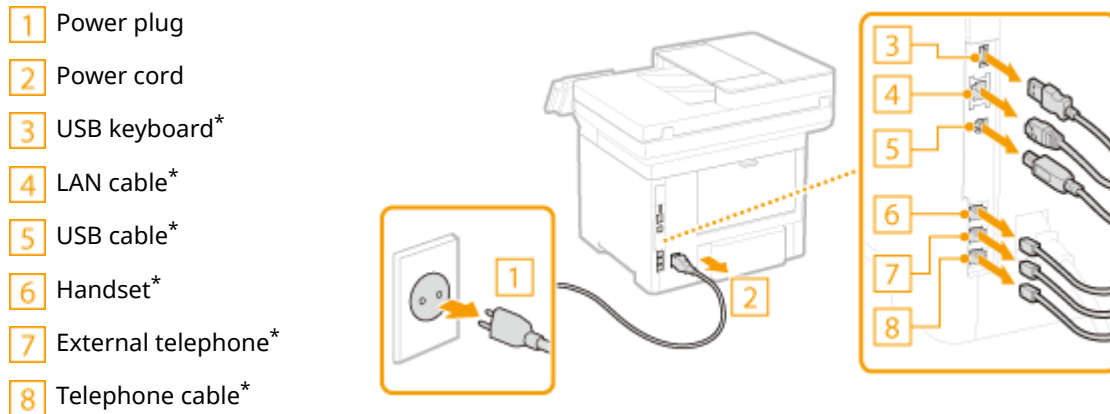

## 3 When transporting the machine across a long distance, remove the toner cartridges.

▶ Procedure for Replacing the Toner Cartridge(P. 567)

## 4 Pull out the paper drawer until it stops, and remove it while lifting the front side.

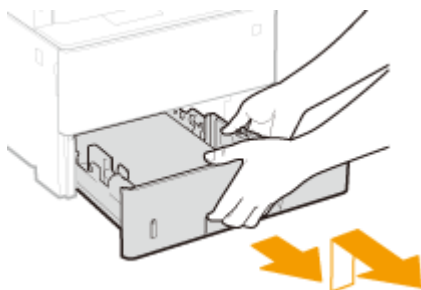

## 5 Close all the open covers and multi-purpose tray, and move the machine to a new location.

- The machine is heavy ( ▶ Main Unit(P. 669) ). Make sure to move the machine with two or more people.
- Hold the lift handles, and lift up the machine.

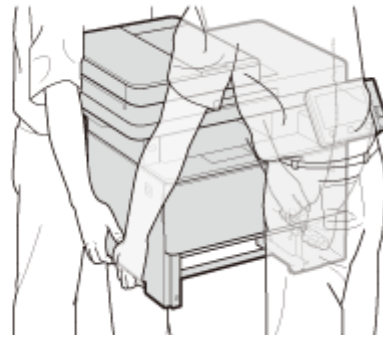
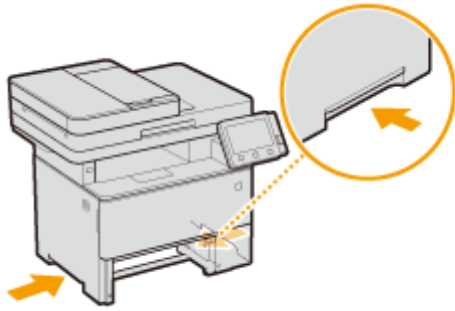

**IMPORTANT:**

If the optional paper feeder is attached to the machine

- Unlock the paper feeder before lifting the machine, and transport the paper feeder separately.

Front Side

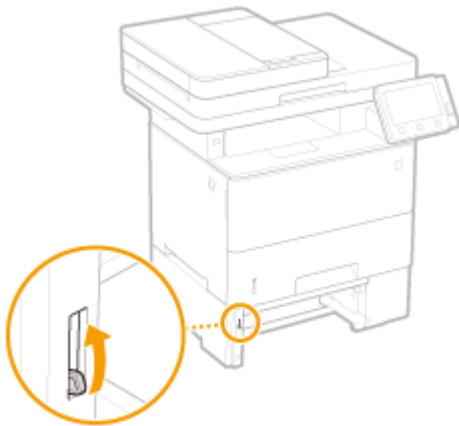

Back Side

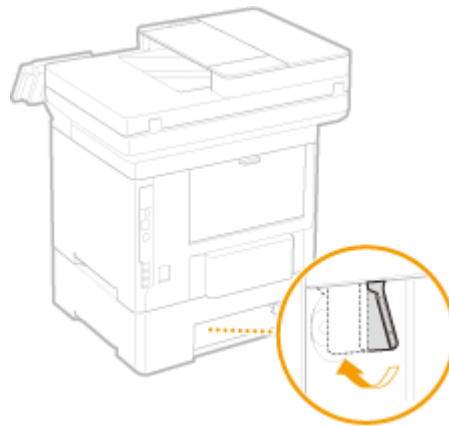

**6 Carefully place the machine at the new installation site.**

- For information about how to install the machine after relocating it, see "Getting Started." **Manuals and Their Contents(P. 692)**

# Adjusting Image Quality

---

261J-09S

If the print results or scanned images are not satisfactory such as low image quality, poor reproducibility, or skewed printouts, try the adjustments below.

## ■ Adjust Copy Image

If the density or brightness of copies and memory media print differs markedly from the originals, use this function so that the appearance of the printing results becomes closer to that of the originals. ▶ **Adjusting the Gradation and Density for Copy Jobs(P. 573)**

## ■ Black Text Processing for Color

You can make an adjustment such that black or nearly black text is reproduced in a color closely matching with the original that was scanned in color. ▶ **Adjusting Values for Text Color Reproducibility(P. 575)**

## ■ Density Adjustment

When the print results are too dark or too light, you can adjust the density. ▶ **Adjusting Print Density(P. 577)**

## ■ Adjust Print Position

You can adjust the print position when the printed image is skewed or part of the image is outside the print range. ▶ **Adjusting Print Position(P. 578)**

# Adjusting the Gradation and Density for Copy Jobs

261J-09U

Gradation refers to the dark to light continuum of shades of a color. The more shades in the gradations of colors that are printed, the more natural printouts seem. If color reproducibility becomes poor and the density and brightness of printouts differs markedly from the originals, perform the appropriate auto adjustment. This adjustment improves the results of copies and memory media print. For correcting copy images, an adjustment image will be printed and scanned. Note that you cannot perform this adjustment while performing some functions, including, scanning, and printing.

## NOTE

- Adjustments may not be performed effectively if there is not sufficient toner cartridge remaining. Check the amount remaining in the toner cartridges. If the amount remaining in the toner cartridge is low, it is recommended that you replace the toner cartridge. **▶Checking the Remaining Amount of Consumables(P. 569)**

- 1** Select **<Menu>** in the Home screen. **▶Home Screen(P. 121)**
- 2** Select **<Adjustment/Maintenance>** ▶ **<Adjust Image Quality>**.
- 3** Select **<Adjust Copy Image>**.
- 4** Check that the size and type of paper displayed on the screen is loaded in the machine, and select **<OK>**.
- 5** Confirm the procedure, and select **<Start>**.  
 ──► An adjustment image is printed.
- 6** Open the feeder after the screen displayed during printing disappears.
- 7** Place the adjustment image on the platen glass.

- Place the adjustment image printed paper with the print side facing down and with the thin black line on the left.



**8 Gently close the feeder.**

**9 Select <Start Scanning>.**

▣ The adjustment image is scanned and adjustment starts.

**10 When a message appears notifying that adjustment is complete, open the feeder, and remove the adjustment image.**

**11 Gently close the feeder.**

## NOTE

### If the <Could not perform correction.> message is displayed

- Did you load the paper displayed in step 4 into the paper source?
- Did you place the adjustment image printed paper on the platen glass with the print side facing down and with the thin black line on the left?
- Has a paper jam occurred? ▶ **Clearing Paper Jams(P. 642)**
- Is the amount remaining in toner cartridge sufficient? If the amount remaining in the toner cartridge is low, it is recommended that you replace the toner cartridge. ▶ **Checking the Remaining Amount of Consumables(P. 569)**

# Adjusting Values for Text Color Reproducibility

261J-09W

You can make an adjustment such that black or nearly black text is reproduced in a color closely matching with the original that was scanned in color.

## NOTE

- This function will apply when scan is performed with <Original Type> set to other than <Photo>.
  - ▶ **Adjusting Image Quality(P. 299)**

- 1** Select <Menu> in the Home screen. ▶ **Home Screen(P. 121)**
- 2** Select <Adjustment/Maintenance> ▶ <Adjust Image Quality>.
- 3** Select <Black Text Processing for Color>.
- 4** Adjust the value.

- This adjustment value can be set independently in the feeder and platen glass.



### <Color Text Priority>

Reproduces black or nearly black text in a color closely matching with the original.

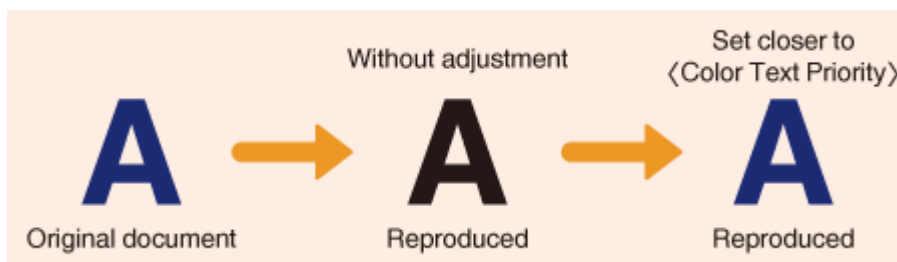

### <Black Text Priority>

Reproduces black text with enhanced clarity.

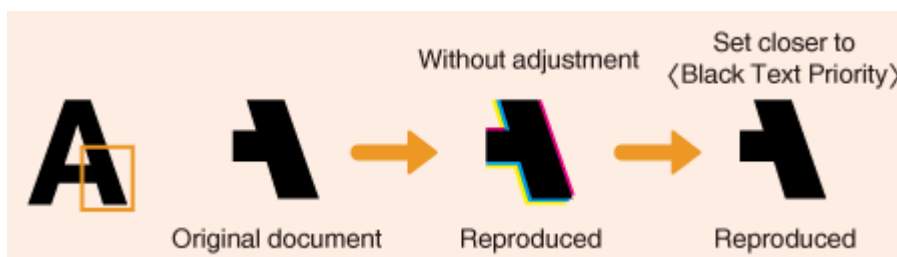

**5** Select <Apply>.



## Adjusting Print Density

---

261J-09X

When the print results are too dark or too light, you can adjust the density.

- 1** Select <Menu> in the Home screen. ▶ Home Screen(P. 121)
- 2** Select <Adjustment/Maintenance> ▶ <Adjust Image Quality>.
- 3** Select <Printer Density>.
- 4** Adjust the density.

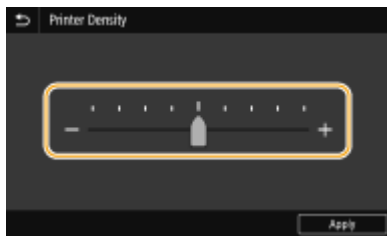

- 5** Select <Apply>.

## Adjusting Print Position

261J-09Y

If a document is printed off-center or out of the printable range, adjust the print position. You can adjust the print position for each paper source. You can adjust the print position in the range -5.0 mm to +5.0 mm in increments of 0.1 mm.

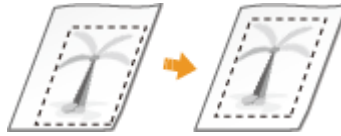

### Checking the Direction and Distance to Adjust

When you adjust the print position, specify the direction using "+" and "-" and the distance using "mm." For <Adjust Vertically (Front Side)>/<Adjust Vertically (Back Side)>, specify a value with a "+" sign to shift the print position in the up-to-down direction. For <Adjust Horizontally (Front Side)>/<Adjust Horizontally (Back Side)>, specify a value with a "+" sign to shift the print position in the left-to-right direction. To shift in the reverse direction, specify a value with a "-" sign.

<Adjust Vertically (Front Side)>/<Adjust Vertically (Back Side)>



<Adjust Horizontally (Front Side)>/<Adjust Horizontally (Back Side)>

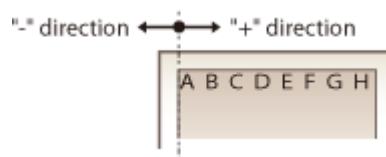

- 1 Select <Menu> in the Home screen. Home Screen(P. 121)
- 2 Select <Adjustment/Maintenance> <Adjust Image Quality>.
- 3 Select <Adjust Print Position>.
- 4 Select the paper source.
  - When the optional paper feeder is installed, its paper drawer is also displayed.

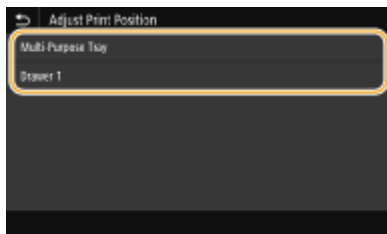

- 5 Select the combination of adjustment direction and printing side.



## 6 Set an adjustment value.



## 7 Select <Apply>.

### Adjusting the Print Position for All Print Jobs

- You can use <Function Settings> in the setting menu of the operation panel to adjust the print position for all print jobs, irrespective of the paper source. The print position can be adjusted in 0.5 mm increments between -50.0 mm and +50.0 mm. ▶<Offset Short Edge/Offset Long Edge>(P. 497)

## Viewing the Counter Value

261J-0A0

You can check the total number of pages printed by the machine. These totals include faxes, reports, and lists, in addition to copies and printouts of data from computers.

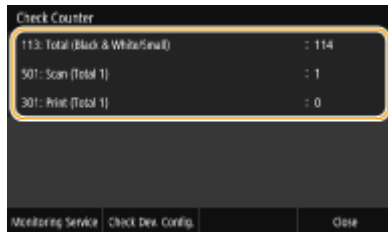
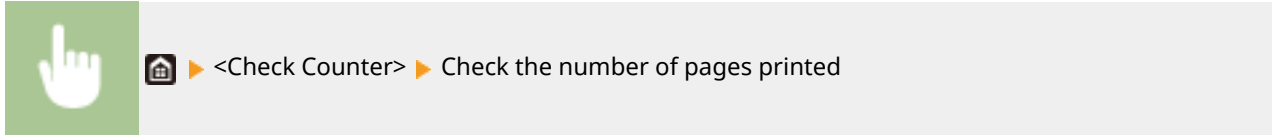

### <113: Total (Black & White/Small)>

Displays the total number of pages copied and printed in black and white.

### <501: Scan (Total 1)>

Displays the total number of pages scanned.

### <301: Print (Total 1)>

Displays the total number of pages printed.

## NOTE

- <Monitoring Service> enables communication with a remote monitoring server. Execution of this item enables information about the machine to be periodically sent to the remote monitoring server connected to the machine.
- <Check Dev. Config.> enables you to check the optional units installed on the machine.

## Printing Reports and Lists

You can print reports and lists to check information such as the total volume of printouts for each <Department ID> and machine settings.

- ▶ **Configuring the Print Settings for Reports and Lists(P. 581)**
- ▶ **Printing a Report on the Total Volume of Printouts by Department ID(P. 581)**
- ▶ **Setting Reports on the Communication Results(P. 581)**
- ▶ **Printing Lists of Settings(P. 583)**
- ▶ **Printing Reports and Lists on the Usage Status of the Machine(P. 584)**

### Configuring the Print Settings for Reports and Lists

You can perform 2-sided printing of reports and lists.



<Menu> ▶ <Output Report> ▶ <Report Settings> ▶ <Default Settings for Report Output> ▶ <On> ▶ <Apply> ▶

### Printing a Report on the Total Volume of Printouts by Department ID

#### Department ID Management Report

When Department ID Management is enabled, you can check the total volume of printouts for each <Department ID> by printing a Department ID Management Report. By checking the printout totals, you can better manage your paper and toner cartridge supplies.



<Menu> ▶ <Output Report> ▶ <Print List> ▶ <Department ID Management Report> ▶ Check that the size and type of paper displayed on the screen is loaded in the machine, and select <Start> ▶

### Setting Reports on the Communication Results

You can print reports on the results of sending/receiving by e-mail, fax, and I-Fax, as well as results of saving to a shared folder or FTP server. Some reports can be printed automatically while others are only printed when an error occurs.

## NOTE

- If "Result" in a printed list contains "NG," you can check details of the error from a three-digit number prefixed with "#" displayed in the next to the result. ▶ **Countermeasures for Each Error Code(P. 632)**
- Reports printed for e-mail/I-Fax indicate the transmission result between the machine and the mail server, not between the machine and the destination address.

## Communication Management Report

You can check the fax and e-mail logs of sent and received documents by printing a Communication Management Report. The report can be printed automatically after every 40 transmissions, or you can print it manually.



<Menu> ▶ <Output Report> ▶ <Report Settings> ▶ <Communication Management Report> ▶ Configure report settings ▶ <Apply> ▶ 

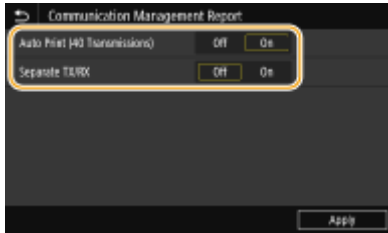

### <Auto Print (40 Transmissions)>

Select <On> to print the report automatically after every 40 transmissions, or <Off> if you do not want to print the report automatically.

### <Separate TX/RX>

Select <On> to print sent and received reports separately, or <Off> to print both reports on one sheet.

## Print the report manually



<Menu> ▶ <Output Report> ▶ <Print List> ▶ <Communication Management Report> ▶ Check that the size and type of paper displayed on the screen is loaded in the machine, and select <Start> ▶ 

## Fax TX Result Report

You can check the fax logs of sent documents by printing a Fax TX Result Report. The report can be printed either every time a transmission is completed or only when a sending error occurs.



<Menu> ▶ <Output Report> ▶ <Report Settings> ▶ <Fax TX Result Report> ▶ Select <On> or <Only When Error Occurs> ▶ Select <Off> or <On> ▶ <Apply> ▶ 

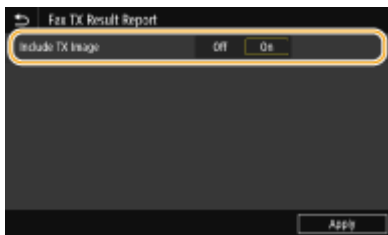

### <Include TX Image>

When you select <On>, a part of a sent document can be included in the TX Result Report.

## E-Mail/I-Fax/File TX Result Report

You can check the e-mail and I-Fax logs of sent documents as well as documents saved to a shared folder or FTP server by printing an E-Mail/I-Fax/File TX Result Report. The report can be printed either every time a transmission is completed or only when a sending error occurs.



<Menu> ▶ <Output Report> ▶ <Report Settings> ▶ <E-Mail/I-Fax/File TX Result Report> ▶ Select <On> or <Only When Error Occurs> ▶

## NOTE

### Communication result

- If an error occurs during transmission by e-mail/I-Fax or saving to a shared folder/FTP server, the report does not show the error code. To check the error code, print a Communication Management Report ( **Communication Management Report(P. 582)** ).

## RX Result Report

You can check the logs of received fax and I-Fax documents by printing an RX Result Report. The report can be printed either every time a transmission is completed or only when a receiving error occurs.



<Menu> ▶ <Output Report> ▶ <Report Settings> ▶ <RX Result Report> ▶ Select <On> or <Only When Error Occurs> ▶

## Printing Lists of Settings

You can print information and settings registered in the machine as a list.

### Address Book List

You can check the list of destinations registered in the Address Book as <Coded Dial>, <Favorites>, and <Group> by printing an Address Book List.



<Menu> ▶ <Output Report> ▶ <Print List> ▶ <Address Book List> ▶ Select the setting you want to print out ▶ Check that the size and type of paper displayed on the screen is loaded in the machine, and select <Start> ▶

### User Data List/System Manager Data List

You can check the list of the settings ( **Setting Menu List(P. 445)** ) as well as the content that has been registered in the machine by printing a User Data List or a System Manager Data List. Both lists include the firmware version, the paper size and type registered in the machine, and the print settings of Communication Management Report, TX Result Report, and RX Result Report.



<Menu> ▶ <Output Report> ▶ <Print List> ▶ Select <User Data List> or <System Manager Data List> ▶ Check that the size and type of paper displayed on the screen is loaded in the machine, and select <Start> ▶

## NOTE

- The User Data List does not include certain settings such as Network Settings and Management Settings. To check all the settings items, print the System Manager Data List.

### IPSec Policy List

You can check the list of policy names and the IPSec settings registered in the machine by printing an IPSec Policy List.



<Menu> ▶ <Output Report> ▶ <Print List> ▶ <IPSec Policy List> ▶ Check that the size and type of paper displayed on the screen is loaded in the machine, and select <Start> ▶

## Printing Reports and Lists on the Usage Status of the Machine

You can print the machine status report, the usage log of toner cartridges, and the list of fonts available in PCL or PS mode.

### Eco Report

You can check the monthly total volume of printouts and the power consumption with a report. This report includes tips that are useful for saving paper and power consumption based on the usage status.



<Menu> ▶ <Output Report> ▶ <Print List> ▶ <Eco Report> ▶ Check that the size and type of paper displayed on the screen is loaded in the machine, and select <Start> ▶

## NOTE

- The amount of power consumption may vary depending on the environment and conditions where the machine is used.

### Consumables Status Report

You can check the consumables status installed in the machine with a report.





<Menu> ▶ <Output Report> ▶ <Print List> ▶ <Consumables Status Report> ▶ Check that the size and type of paper displayed on the screen is loaded in the machine, and select <Start> ▶

### PCL Font List

You can check the list of fonts available in PCL mode with a report.



<Menu> ▶ <Output Report> ▶ <Print List> ▶ <PCL Font List> ▶ Check that the size and type of paper displayed on the screen is loaded in the machine, and select <Start> ▶

### PS Font List

You can check the list of fonts available in PS mode with a report.



<Menu> ▶ <Output Report> ▶ <Print List> ▶ <PS Font List> ▶ Check that the size and type of paper displayed on the screen is loaded in the machine, and select <Start> ▶

### Cartridge Log Report

You can check the usage logs of toner cartridges with a report.



<Menu> ▶ <Output Report> ▶ <Print List> ▶ <Cartridge Log Report> ▶ Check that the size and type of paper displayed on the screen is loaded in the machine, and select <Start> ▶

# Consumables

261J-0A2

The following is a guide to the estimated replacement time for the consumables used in this machine. Purchase consumables at your local authorized Canon dealer. Observe safety and health precautions when storing and handling consumables. For optimum print quality, using Canon genuine Toner, Cartridge and Parts is recommended.



## NOTE

- To handle and store consumables, observe precautions in "Getting Started" provided for this product.
- Depending on the installation environment, printing paper size, or original type, you may need to replace consumables before the end of the estimated lifetime.
- Specifying an auto shutdown time shorter than the default setting (4 hours) may shorten the life of the toner cartridges.

### ■ Toner Cartridges

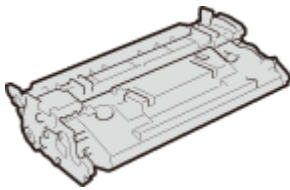

#### Supplied Toner Cartridges

The average yield and the weight of the toner cartridge that comes with the machine are shown below.

- Average yield\*  
10,000 sheets
- Weight  
Approx. 1.0 kg

#### Replacement Toner Cartridges

For optimum print quality, using Canon genuine toner cartridges is recommended.

Canon Genuine Toner Cartridge	Average yield and weight of toner cartridge
Canon Cartridge 041	<ul style="list-style-type: none"> <li>• Average yield* 10,000 sheets</li> <li>• Weight Approx. 1.0 kg</li> </ul>
Canon Cartridge 041 H	<ul style="list-style-type: none"> <li>• Average yield* 20,000 sheets</li> <li>• Weight Approx. 1.4 kg</li> </ul>

\* The average yield is based on "ISO/IEC 19752" (the global standard related to "Method for the determination of toner cartridge yield for monochromatic electrophotographic printers and multi-function devices that contain printer components" issued by ISO [International Organization for Standardization]) when printing A4 size paper with the default print density setting.

## IMPORTANT

### Be careful of counterfeit toner cartridges

- Please be aware that there are counterfeit Canon toner cartridges in the marketplace. Use of counterfeit toner cartridge may result in poor print quality or machine performance. Canon is not responsible for any malfunction, accident or damage caused by the use of counterfeit toner cartridge. For more information, see [canon.com/counterfeit](http://canon.com/counterfeit).

## NOTE

- When replacing toner cartridges, see  **Replacing the Toner Cartridge(P. 566)** .

# Troubleshooting

<b>Troubleshooting</b> .....	589
<b>Common Problems</b> .....	591
Installation/Settings Problems .....	592
Copying/Printing Problems .....	596
Faxing/Telephone Problems .....	599
<b>When You Cannot Print Properly</b> .....	601
Printing Results Are Not Satisfactory .....	603
Paper Creases or Curls .....	614
Paper Is Fed Incorrectly .....	616
<b>A Message or a Number Starting with "#" (an Error Code) Is Displayed</b> .....	617
Countermeasures for Each Message .....	618
Countermeasures for Each Error Code .....	632
<b>Clearing Paper Jams</b> .....	642
Paper Jams in the Feeder .....	644
Paper Jams in the Main Unit .....	646
Paper Jams in a Paper Source .....	652
<b>When a Problem Cannot Be Solved</b> .....	654

# Troubleshooting

---

261J-0A3

When a problem occurs, check this chapter to find out solutions before contacting Canon.

## ■ Common Problems

This section describes how to take action when you suspect that the machine is malfunctioning. ▶ **Common Problems(P. 591)**



## ■ When You Cannot Print Properly

This section describes how to take action when printing results are not satisfactory or the paper creases or curls. ▶ **When You Cannot Print Properly(P. 601)**



## ■ A Message or a Number Starting with "#" (an Error Code) is Displayed

This section describes how to take action when a message or error code (three digits) appears on the display. ▶ **A Message or a Number Starting with "#" (an Error Code) Is Displayed(P. 617)**



## ■ Clearing Paper Jams

This section describes how to take action when a paper is jammed. ▶ **Clearing Paper Jams(P. 642)**



## ■ When a Problem Cannot Be Solved

If a problem persists, see ▶ **When a Problem Cannot Be Solved(P. 654)** to find out where to contact.

## Troubleshooting



## Common Problems

---

261J-0A4

If you encounter problems when using the machine, check the items in this section before contacting us. If the problems persist, contact your local authorized Canon dealer or the Canon help line.

### Check the Following

#### → Is the machine turned ON? Is the power cord connected?

- If the machine is turned ON but does not respond, turn it OFF, check whether the power cord is connected correctly, and turn it back ON. For information on connecting the power cord, see Getting Started. ▶ **Manuals and Their Contents(P. 692)**

#### → Are the phone cord, LAN cable and USB cable connected correctly?

- Check whether these cables are connected correctly. Use care not to mistake the phone cord's port for the other cables' ports.
  - ▶ **Connecting the Telephone Line(P. 83)**
  - ▶ **Parts and Their Functions(P. 105)**

#### → Is sleep mode activated?

- If you leave the machine unattended for a specific period of time, it enters sleep mode for power conservation, not allowing you to operate it. To cancel sleep mode, press .

#### → Is any message displayed on the screen?

- If a problem occurs, a message is displayed. ▶ **Countermeasures for Each Message(P. 618)**

### If a problem persists even after checking

---

Click the link that corresponds to the problem.

- ▶ **Installation/Settings Problems(P. 592)**
- ▶ **Copying/Printing Problems(P. 596)**
- ▶ **Faxing/Telephone Problems(P. 599)**

# Installation/Settings Problems

261J-0A5

See [▶Common Problems\(P. 591\)](#) also.

- ▶[Problems with the Wireless/Wired LAN Connection\(P. 592\)](#)
- ▶[Problem with the USB Connection\(P. 595\)](#)
- ▶[Problem with the Print Server\(P. 595\)](#)

## Problems with the Wireless/Wired LAN Connection

### The wireless LAN and wired LAN cannot be connected at the same time.

- The wireless LAN and wired LAN cannot be connected at the same time. The following can be used at the same time: a USB cable and a wireless LAN, or a USB cable and a wired LAN.

### Remote UI is not displayed.

- Are <Use HTTP> and <Use Remote UI> set to <On>?
  - ▶[Disabling HTTP Communication\(P. 410\)](#)
  - ▶[Disabling Remote UI\(P. 411\)](#)
- If the machine is connected to a wireless LAN, check that the Wi-Fi icon is displayed in the Home screen and that the IP address is set correctly, and then start the Remote UI again.
  - ▶[Home Screen\(P. 121\)](#)
  - ▶[Viewing Network Settings\(P. 38\)](#)
- If the machine is connected to a wired LAN, check that the cable is connected firmly and the IP address is set correctly, and then start the Remote UI again.
  - ▶[Connecting to a Wired LAN\(P. 17\)](#)
  - ▶[Viewing Network Settings\(P. 38\)](#)
- Are you using a proxy server? If so, add the machine's IP address to the [Exceptions] list (addresses that do not use the proxy server) in the Web browser's proxy settings dialog.
- Is communication not limited by the firewall on your computer? If IP addresses are or an MAC address is incorrectly entered, the Remote UI cannot be displayed. In that case, you need to use the operation panel to set <IPv4 Address Filter>, <IPv6 Address Filter>, or <MAC Address Filter> to <Off>.
  - ▶[Restricting Communication by Using Firewalls\(P. 365\)](#)
  - ▶[<IPv4 Address Filter> \(P. 469\)](#)
  - ▶[<IPv6 Address Filter> \(P. 469\)](#)
  - ▶[<MAC Address Filter> \(P. 469\)](#)

### A connection to a network cannot be established.

- The IP address may not be set correctly. Set the IP address again.
  - ▶[Setting IP Addresses\(P. 31\)](#)
- When you connect the machine to a computer via wireless LAN, check whether the machine is properly installed and ready to connect to the network.
  - ▶[When the Machine Cannot Connect to the Wireless LAN\(P. 593\)](#)



**You are unsure of the set IP address. ▶ Viewing Network Settings(P. 38)**

**The connection method cannot be switched between a wired LAN and a wireless LAN.**

- Did you select a wired LAN or a wireless LAN on the operation panel on the machine as well? This selection is required to have the machine switch to your selection.  
▶ **Selecting Wired LAN or Wireless LAN(P. 16)**

**You are unsure of the SSID or the network key of the wireless router to be connected. The SSID is not displayed on the screen.**

- Check whether the SSID can be found on the wireless router or package box.
- Check the SSID or the network key of the wireless router by using Canon MF/LBP Wireless Setup Assistant.  
▶ **Checking the SSID and Network Key(P. 30)**

**The SSID of the wireless router to be connected is not displayed in the access point list.**

- Check whether the SSID is correct.  
▶ **Checking the SSID and Network Key(P. 30)**
- If the SSID of the wireless router is hidden (using a stealth mode\*), set the SSID to be visible on the wireless router.

\* A mode that disables the SSID auto-detection of other devices.

- Check whether the machine is properly installed and ready to connect to the network.  
▶ **When the Machine Cannot Connect to the Wireless LAN(P. 593)**

**The machine dials up to an unintended connection destination (if a dialup router is connected to a network).**

- If a dialup router does not need to pass broadcast packets, set the dialup router so that the broadcast packets will not pass. If the dialup router needs to pass broadcast packets, check whether the settings are correct.
- If a DNS server is located in an external network, set the IP address to be connected, not the host name, even if connecting to the devices that are on the network that is connected to the machine.
- If a DNS server is located on a network that is connected to the machine and the information about the devices that are connected to an external network is registered to the DNS server, check whether the settings are correct.

**When the Machine Cannot Connect to the Wireless LAN**

---



**1 Check the status of your computer.**

- Have the settings of the computer and the wireless router been completed?
- Are the cables of the wireless router (including the power cord and LAN cable) correctly plugged in?
- Is the wireless router turned on?

**If the problem persists even after checking the above:**

- Turn off the devices, and then turn them on again.
- Wait for a while, and try again to connect to the network.



**Check whether the machine is turned ON.**

- If the machine is turned ON, turn it OFF, and then turn it back ON.



**Check the installation site of the machine and the wireless router.**

- Is the machine too far from the wireless router?
- Are there any obstacles such as walls between the machine and the wireless router?
- Are there any appliances such as microwave ovens or digital cordless phones that emit radio waves near the machine?

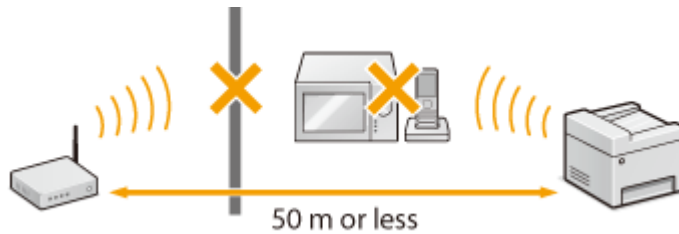

**Perform one of the following settings again.**

- ▶ **Setting Up Connection Using WPS Push Button Mode(P. 20)**
- ▶ **Setting Up Connection Using WPS PIN Code Mode(P. 22)**
- ▶ **Setting Up Connection by Selecting a Wireless Router(P. 24)**
- ▶ **Setting Up Connection by Specifying Detailed Settings(P. 27)**

## NOTE

### When you need to manually set up the connection

If the wireless router is set as described below, manually enter all the required information for the wireless LAN connection ( ▶ **Setting Up Connection by Specifying Detailed Settings(P. 27)** ).

- ANY connection refusal\* is activated.
- The WEP key that was automatically generated (hexadecimal) is selected.
- The stealth mode is activated.

\* A function in which the wireless router refuses the connection if the SSID on the device to be connected is set to "ANY" or is blank.

### When you need to change the settings of the wireless router

If the wireless router is set as described below, change the settings of the router.

- The MAC address packet filtering is set.

- When only IEEE 802.11n is used for the wireless communication, WEP is selected or the WPA/WPA2 encryption method is set to TKIP.

## Problem with the USB Connection

### Cannot communicate.

- Change the USB cable. If you are using a long USB cable, replace it with a short one.
- If you are using a USB hub, connect the machine directly to your computer using a USB cable.

## Problem with the Print Server

### You cannot find the print server to connect to.

- Are the print server and computer connected correctly?
- Is the print server running?
- Do you have user rights to connect to the print server? If you are not sure, contact the server administrator.
- Is [Network discovery] enabled?
  - ▶ **Enabling [Network discovery](P. 698)**

### You cannot connect to a shared printer.

- On the network, does the machine appear among the printers of the print server? If it is not displayed, contact the network or server administrator.
  - ▶ **Displaying Shared Printers in the Print Server(P. 699)**

# Copying/Printing Problems

261J-0A6

See [▶Common Problems\(P. 591\)](#) also.

## Printing/copy results are not satisfactory. Paper creases or curls. ▶When You Cannot Print Properly(P. 601)

### You cannot print.

- Can you print a Windows test page? If you can print a Windows test page, there is no problem with the machine or the printer driver. Check the print settings of your application.

#### ▶Printing a Test Page in Windows(P. 700)

If the problems persist, check the items that suit your operational environment.

#### ■ Wireless LAN connection

- Check the connection status (signal strength) of the wireless LAN.

#### ▶Viewing Network Settings(P. 38)

### NOTE:

- If the connection is poor, try the following.
  - Change the channel of your wireless LAN router. If you have more than one router, set the channels to be at least five channels apart.
  - If you can change the radio output power of your wireless LAN router, raise the output power.
- If your computer is connected to a wireless LAN, are the computer and this machine using the same wireless LAN router SSID? If they are different, reset the wireless LAN connection settings of this machine.
  - ▶Viewing Network Settings(P. 38)
  - ▶Checking the SSID to Which Your Computer is Connected(P. 705)
  - ▶Connecting to a Wireless LAN(P. 18)

### NOTE:

#### When you reset wireless LAN connection settings

- As the wireless LAN router, select the one with the SSID to which the computer is connected.
  - Have you selected the correct port? If there is no port to use, create a port.
    - ▶Checking the Printer Port(P. 703)
    - ▶Configuring Printer Ports(P. 44)
  - Is communication not limited by the firewall on your computer? If IP addresses are incorrectly entered, you will be not able to access the machine. In that case, you need to use the operation panel to set <IPv4 Address Filter> or <IPv6 Address Filter> to <Off>.
    - ▶Restricting Communication by Using Firewalls(P. 365)
    - ▶<IPv4 Address Filter> (P. 469)
    - ▶<IPv6 Address Filter> (P. 469)
  - Disable security software and other resident software.
  - Reinstall the printer driver.
    - ▶Installing Drivers(P. 78)

- Can you print from other computers on the network? If you also cannot print from other computers, contact your local authorized Canon dealer or the Canon help line.

■ **Wired LAN connection**

- Have you selected the correct port? If there is no port to use, create a port.
  - ▶ **Checking the Printer Port(P. 703)**
  - ▶ **Configuring Printer Ports(P. 44)**
- Is communication not limited by the firewall on your computer? If IP addresses are or an MAC address is incorrectly entered, you will be not able to access the machine. In that case, you need to use the operation panel to set <IPv4 Address Filter>, <IPv6 Address Filter>, or <MAC Address Filter> to <Off>.
  - ▶ **Restricting Communication by Using Firewalls(P. 365)**
  - ▶ **<IPv4 Address Filter> (P. 469)**
  - ▶ **<IPv6 Address Filter> (P. 469)**
  - ▶ **<MAC Address Filter> (P. 469)**
- Disable security software and other resident software.
- Reinstall the printer driver.
  - ▶ **Installing Drivers(P. 78)**
- Can you print from other computers on the network? If you also cannot print from other computers, contact your local authorized Canon dealer or the Canon help line.

■ **USB connection**

- Have you selected the correct port? If there is no port to use or you are not sure, reinstall the printer driver. When you reinstall the printer driver, the correct port is created automatically.
  - ▶ **Checking the Printer Port(P. 703)**
  - ▶ **Installing Drivers(P. 78)**
- Is bidirectional communication enabled? Enable bidirectional communication, and restart the computer.
  - ▶ **Checking Bidirectional Communication(P. 704)**
- Disable security software and other resident software.
- Connect to another USB port on the computer.
- Can you print from a USB connection to another computer? If you also cannot print from other computers, contact your local authorized Canon dealer or the Canon help line.

■ **Via print server**

- Can you print from the print server? If you can print from the print server, check the connection between the print server and your computer.
  - ▶ **Problem with the Print Server(P. 595)**
- Disable security software and other resident software.
- Reinstall the printer driver.
  - ▶ **Installing Drivers(P. 78)**
- Can you print from other computers via the print server? If you also cannot print from other computers, contact your local authorized Canon dealer or the Canon help line.
- Are you printing with the lpr command? To continuously print PDF data using the lpr command, print jobs one by one at intervals according to the <Timeout> setting.
  - ▶ **<Timeout>(P. 498)**
- Has an error occurred? Check the job log.
  - ▶ **Checking the Copying Status and Log(P. 197)**
  - ▶ **Checking the Printing Status and Log(P. 258)**

### **Printing seems to be slow. \***

- Disabling Secure Print is recommended if you are not using it.  
▶ **Changing the Valid Time Period for Secured Documents(P. 264)**

\* When the free space in memory is running low, the processing speed of the machine becomes slow, just as a computer does. There is nothing abnormal.

### **You cannot print with Google Cloud Print. ▶ Using Google Cloud Print(P. 341)**

### **It takes a long time before printing starts.**

- Did you print to narrow width paper? After you print to narrow width paper, the machine may cool itself to maintain the print quality. As a result, it may take some time before the next job is printed. Wait until the machine is ready to print. Printing will resume when the temperature inside the machine has fallen.

# Faxing/Telephone Problems

261J-0A7

See **Common Problems(P. 591)** also.

**Sending Problems(P. 599)**

**Receiving Problems(P. 600)**

## Sending Problems

### A fax cannot be sent.

- Is an external phone line busy? Wait until the line becomes free.
- Has an error occurred? Print and check a Communication Management Report.
  - ▶ **Communication Management Report(P. 582)**
- Is a telephone line set correctly?
  - ▶ **Connecting the Telephone Line(P. 83)**
- When sending the fax overseas, insert pauses in the fax number.
  - ▶ **Basic Operations for Sending Faxes(P. 214)**

### A fax cannot be sent with a destination in the history specified.

- Did you turn OFF the machine? If so, the stored history was deleted.
- Did you set <Restrict New Destinations> to <On>? If so, the history before you set was deleted.
- Did you set <Restrict Resending from Log> to <On>? If so, the destinations in the history cannot be specified.

### A fax cannot be sent on an optical fiber line.

- The machine is compliant with use on analog lines. When using an optical fiber line or IP phone line, the machine may not work correctly depending on the connection environment or connected devices. In such a case, contact the provider of the optical fiber line or IP phone.

### The results of a sent fax are not satisfactory.

- Clean the platen glass or feeder. If cleaning does not improve the results, the recipient's fax machine may be a cause.
  - ▶ **Cleaning the Platen Glass(P. 561)**
  - ▶ **Cleaning the Feeder(P. 562)**

## Receiving Problems

### The results of received fax are not satisfactory. Paper creases or curls. ▶ When You Cannot Print Properly(P. 601)

#### Telephone and fax cannot be switched automatically.

- Check that the receive mode is set to <Fax/Tel (Auto Switch)>, <Answering Machine>, or <Net Switch>.
  - ▶ **Receiving Faxes(P. 223)**
- Free space in memory may be running low. Print or delete data in memory.
  - ▶ **Checking/Forwarding/Deleting Documents in Memory(P. 235)**
  - ▶ **Printing Documents in Memory(P. 235)**

#### A fax cannot be received automatically.

- Check that the receive mode is set to <Fax/Tel (Auto Switch)>, <Auto>, <Answering Machine>, or <Net Switch>.
  - ▶ **Receiving Faxes(P. 223)**
- Free space in memory may be running low. Print or delete data in memory.
  - ▶ **Checking/Forwarding/Deleting Documents in Memory(P. 235)**
  - ▶ **Printing Documents in Memory(P. 235)**

#### A fax cannot be received on an optical fiber line.

- The machine is compliant with use on analog lines. When using an optical fiber line or IP phone line, the machine may not work correctly depending on the connection environment or connected devices. In such a case, contact the provider of the optical fiber line or IP phone.



## When You Cannot Print Properly

261J-0A8

If printing results are not satisfactory, or paper creases or curls, try the following solutions. If the problems persist, contact your local authorized Canon dealer or the Canon help line.

### ■ Problems with Image Quality ▶ Printing Results Are Not Satisfactory(P. 603)

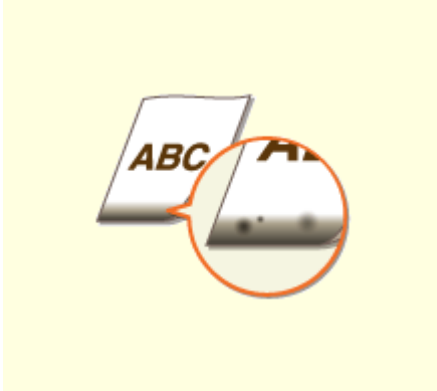

▶ Smudge Marks Appear on the Bottom Edge of Printouts(P. 603)



▶ Smudges Appear on Printouts(P. 603)



▶ Afterimages Appear in Blank Areas(P. 605)



▶ Toner Smudges and Splatters Appear(P. 606)



▶ Printouts Are Faded(P. 606)

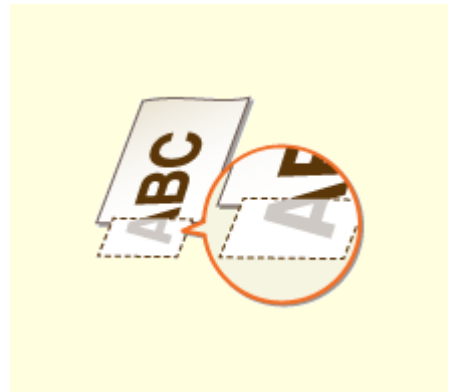

▶ A Portion of the Page Is Not Printed(P. 608)



▶ Streaks Appear/Printing is Uneven(P. 609)

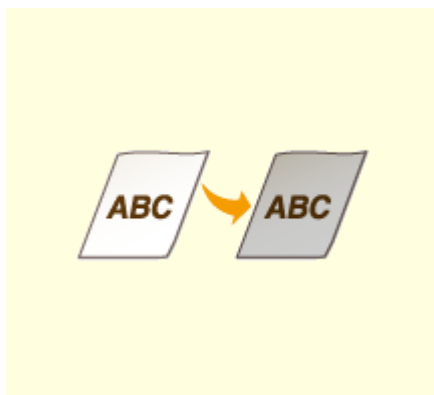

▶ Printouts Are Grayish(P. 610)



▶ White Spots Appear(P. 611)



▶ Black Spots Appear(P. 612)



▶ Reverse Side of Paper is Smudged(P. 612)



▶ Printed Barcode Cannot Be Read(P. 613)

■ Problems with Printout Paper ▶ Paper Creases or Curls(P. 614)



▶ Paper Creases(P. 614)



▶ Paper Curls(P. 614)

■ Problems with Paper Feed ▶ Paper Is Fed Incorrectly(P. 616)



▶ Printouts Are Skewed(P. 616)



▶ Paper Is Not Fed/Two or More Sheets Are Fed Together(P. 616)

## Printing Results Are Not Satisfactory

261J-0A9

Dirt inside the machine may affect printing results. Perform care and cleaning to the machine first. **▶Regular Cleaning(P. 559)**

### Smudge Marks Appear on the Bottom Edge of Printouts

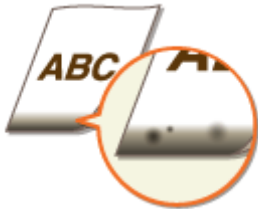

#### → Are you using appropriate paper?

- Check the supported paper types and replace with an appropriate type. Also, set the paper size and type correctly.
  - ▶ **Available Paper(P. 673)**
  - ▶ **Loading Paper(P. 138)**
  - ▶ **Specifying Paper Size and Type(P. 154)**

#### → Do you print data without margins?

- This symptom occurs if a margin is set to none in the printer driver. A margin of 5 mm or less around the edge of paper or 10 mm or less around the edge of envelopes is not printable with the machine. Make sure to have margins around the document to print.

[Finishing] tab ▶ [Advanced Settings] ▶ [Expand Print Region and Print] ▶ [Off]

### Smudges Appear on Printouts



#### → Are you using appropriate paper?

- Check usable paper, and replace with appropriate paper.
  - ▶ **Available Paper(P. 673)**
  - ▶ **Loading Paper(P. 138)**

### → Do smudges appear when using the machine in an environment with low humidity?

- Change the setting for <Low Humidity Mode>. The improvement effect is stronger with <Mode 2> than <Mode 1>. First try with <Mode 1>.  
 ▶<Low Humidity Mode>(P. 478)

#### NOTE:

- If <Low Humidity Mode> is specified, print density may be lower or uneven when the machine is used in an environment with high humidity.

### → Do smudges appear on printouts depending on the paper type or the operating environment?

- Change the setting of <Correct Blurry Image>. The improvement effect is weakest with <Mode 1> and strongest with <Mode 4>. Try the adjustment starting with <Mode 1>.  
 ▶<Correct Blurry Image>(P. 480)

#### NOTE:

- Setting a stronger improvement effect may result in lighter print density or slower printing speed. It may also result in less sharp edges and rougher details.
- If [Barcode Adjustment Mode] in the printer driver is specified, the <Correct Blurry Image> setting is disabled.

### → Is the machine installed in an environment where the temperature changes rapidly and drastically?

- When the temperature changes rapidly in the environment where the machine is installed, condensation occurs, which may cause fading or bleeding in images and text. If <Control Condensation> is set to <On>, condensation inside the machine will be removed. Condensation removal may be performed automatically due to temperature change.  
 ▶<Control Condensation>(P. 482)

#### IMPORTANT:

- While condensation removal is being performed, printing may not be performed properly and blank paper may be output.
- If you set to <On>, you need to keep the machine turned ON to maintain the effect of condensation removal.

#### NOTE:

- The setting for <Auto Shutdown Time> is unavailable when <Control Condensation> is set to <On>.

### → Do smudges appear on copy job output depending on the paper type or the environmental conditions?

- Changing the setting of <Correct Blurry Image for Copy> may solve the problem. The improvement effect is weakest with <Mode 1> and strongest with <Mode 3>.  
 ▶<Correct Blurry Image for Copy>(P. 481)

## NOTE:

- Setting a stronger improvement effect may result in lighter print density.

## Afterimages Appear in Blank Areas



### → Are you using appropriate paper?

- Check usable paper, and replace with appropriate paper.
  - ▶ **Available Paper(P. 673)**
  - ▶ **Loading Paper(P. 138)**

### → Do afterimages appear when you print on large size paper after printing on small size paper?

- Change the setting for <Reduce Ghosting 1>. Setting to <On> may solve the problem.
  - ▶ **<Reduce Ghosting 1>(P. 479)**

## NOTE:

- If you set to <On>, the printing speed may be slower.

### → Do ghost images appear in the same page?

- Change the setting for <High Humidity Mode>. Setting to <On> may solve the problem.
  - ▶ **<High Humidity Mode>(P. 478)**

## NOTE:

- If you set to <On>, the print density may vary depending on the ambient humidity.

### → Is the amount remaining in toner cartridge running low?

- Check how much the amount remaining in toner cartridges is left, and replace the toner cartridges as necessary.
- Regardless of the displayed toner level, the toner cartridge may have reached the end of its lifetime due to the machine's environmental conditions and the deteriorated materials in the cartridge. Replace the toner cartridge.
  - ▶ **Replacing the Toner Cartridge(P. 566)**

## Toner Smudges and Splatters Appear



### → Are you using appropriate paper?

- Check usable paper, and replace with appropriate paper.
  - ▶ **Available Paper(P. 673)**
  - ▶ **Loading Paper(P. 138)**

### → Do toner smudges and splatters appear when using the machine in an environment with low humidity?

- Change the setting for <Low Humidity Mode>. The improvement effect is stronger with <Mode 2> than <Mode 1>. First try with <Mode 1>.
  - ▶ **<Low Humidity Mode>(P. 478)**

### NOTE:

- If <Low Humidity Mode> is specified, print density may be lower or uneven when the machine is used in an environment with high humidity.

### → Is the amount remaining in toner cartridge running low?

- Check how much the amount remaining in toner cartridges is left, and replace the toner cartridges as necessary.
- Regardless of the displayed toner level, the toner cartridge may have reached the end of its lifetime due to the machine's environmental conditions and the deteriorated materials in the cartridge. Replace the toner cartridge.
  - ▶ **Replacing the Toner Cartridge(P. 566)**

## Printouts Are Faded



### → Are you using appropriate paper?

- Check usable paper, and replace with appropriate paper. Also, specify the paper size and type settings properly.
  - ▶ **Available Paper(P. 673)**
  - ▶ **Loading Paper(P. 138)**
  - ▶ **Specifying Paper Size and Type(P. 154)**

### → Is the machine installed in an environment where the temperature changes rapidly and drastically?

- When the temperature changes rapidly in the environment where the machine is installed, condensation occurs, which may cause fading or bleeding in images and text. If <Control Condensation> is set to <On>, condensation inside the machine will be removed. Condensation removal may be performed automatically due to temperature change.
  - ▶ **<Control Condensation>(P. 482)**

#### IMPORTANT:

- While condensation removal is being performed, printing may not be performed properly and blank paper may be output.
- If you set to <On>, you need to keep the machine turned ON to maintain the effect of condensation removal.

#### NOTE:

- The setting for <Auto Shutdown Time> is unavailable when <Control Condensation> is set to <On>.

### → Are the printouts faded when you print on envelopes?

- Printouts may be faded when you print on envelopes with rough surfaces. Setting <Rough Surface Envelope Mode> to <On> may solve the problem.
  - ▶ **<Rough Surface Envelope Mode>(P. 477)**

#### NOTE:

If you set <Rough Surface Envelope Mode> to <On>

- The <Paper Curl Correction> setting will be disabled.
- The printing speed may be slower.

### → Is the amount remaining in toner cartridge running low?

- Check how much the amount remaining in toner cartridges is left, and replace the toner cartridges as necessary.
- Regardless of the displayed toner level, the toner cartridge may have reached the end of its lifetime due to the machine's environmental conditions and the deteriorated materials in the cartridge. Replace the toner cartridge.
  - ▶ **Replacing the Toner Cartridge(P. 566)**

## A Portion of the Page Is Not Printed

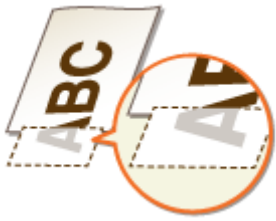

### → Do you print data without margins?

- This symptom occurs if a margin is set to none in the printer driver. A margin of 5 mm or less around the edge of paper or 10 mm or less around the edge of envelopes is not printable with the machine. Make sure to have margins around the document to print.

[Finishing] tab ▶ [Advanced Settings] ▶ [Expand Print Region and Print] ▶ [Off]

### → Do the paper guides align with the edges of the paper?

- If the paper guides are too loose or too tight, part of a document may not be printed.  
 ▶ **Loading Paper(P. 138)**

### → Is the machine installed in an environment where the temperature changes rapidly and drastically?

- When the temperature changes rapidly in the environment where the machine is installed, condensation occurs, which may cause fading or bleeding in images and text. If <Control Condensation> is set to <On>, condensation inside the machine will be removed. Condensation removal may be performed automatically due to temperature change.

▶ **<Control Condensation>(P. 482)**

### IMPORTANT:

- While condensation removal is being performed, printing may not be performed properly and blank paper may be output.
- If you set to <On>, you need to keep the machine turned ON to maintain the effect of condensation removal.

### NOTE:

- The setting for <Auto Shutdown Time> is unavailable when <Control Condensation> is set to <On>.



## Streaks Appear/Printing is Uneven



### → Are you using appropriate paper?

- Check usable paper, and replace with appropriate paper.
  - ▶ **Available Paper(P. 673)**
  - ▶ **Loading Paper(P. 138)**

### → Is the platen glass dirty?

- Clean the platen glass and the underside of the feeder.
  - ▶ **Cleaning the Platen Glass(P. 561)**

### → Have you cleaned the fixing unit?

- Clean the fixing unit.
  - ▶ **Cleaning the Fixing Assembly(P. 565)**

### → Is the machine installed in an environment where the temperature changes rapidly and drastically?

- When the temperature changes rapidly in the environment where the machine is installed, condensation occurs, which may cause fading or bleeding in images and text. If <Control Condensation> is set to <On>, condensation inside the machine will be removed. Condensation removal may be performed automatically due to temperature change.
  - ▶ **<Control Condensation>(P. 482)**

### IMPORTANT:

- While condensation removal is being performed, printing may not be performed properly and blank paper may be output.
- If you set to <On>, you need to keep the machine turned ON to maintain the effect of condensation removal.

### NOTE:

- The setting for <Auto Shutdown Time> is unavailable when <Control Condensation> is set to <On>.

### → Do black horizontal streaks appear in the leading edge of paper?

- Change the setting of <Rdc. Wrinkles(Humidity)/Streaks>. Setting to <On> may solve the problem.
  - ▶ **<Rdc. Wrinkles(Humidity)/Streaks>(P. 479)**

## NOTE:

- If you set to <On>, the printing speed will be slower.

### → Is the amount remaining in toner cartridge running low?

- Check how much the amount remaining in toner cartridges is left, and replace the toner cartridges as necessary.
- Regardless of the displayed toner level, the toner cartridge may have reached the end of its lifetime due to the machine's environmental conditions and the deteriorated materials in the cartridge. Replace the toner cartridge.
  - ▶ **Replacing the Toner Cartridge(P. 566)**

## Printouts Are Grayish



### → Does the original have background color, is it stained, or are you copying an original such as a newspaper that is printed on thin paper so that text or images on the other side are visible through the paper?

- Check the original and then adjust the density to the correct settings.
  - ▶ **Basic Copy Operations(P. 191)**

### → Does the white background become dark?

- Change the <Background Density> setting. Changing the <Adjust (Manual)> setting may solve the problem.
  - ▶ **Basic Copy Operations(P. 191)**

## NOTE:

- Depending on the original color, portions other than the background may be affected.

### → Is the machine installed in the appropriate environment?

- Install the machine in an appropriate location.
  - ▶ **Relocating the Machine(P. 570)**
- Store the toner cartridge in an appropriate location for two to three hours, then try printing again. This may solve the problem. If the problem persists, replace the toner cartridge.
  - ▶ **Replacing the Toner Cartridge(P. 566)**

## White Spots Appear



### → Are you using paper that has absorbed moisture?

- Replace with appropriate paper.  
▶ **Loading Paper(P. 138)**

### → Are you using appropriate paper?

- Check usable paper, and replace with appropriate paper.  
▶ **Available Paper(P. 673)**  
▶ **Loading Paper(P. 138)**

### → Does a void appear at the center of dark text or lines?

- Change the setting for <High Humidity Mode>. Setting to <On> may solve the problem.  
▶ **<High Humidity Mode>(P. 478)**

### NOTE:

- If you set to <On>, the print density may vary depending on the ambient humidity.

### → Is the machine installed in an environment where the temperature changes rapidly and drastically?

- When the temperature changes rapidly in the environment where the machine is installed, condensation occurs, which may cause fading or bleeding in images and text. If <Control Condensation> is set to <On>, condensation inside the machine will be removed. Condensation removal may be performed automatically due to temperature change.  
▶ **<Control Condensation>(P. 482)**

### IMPORTANT:

- While condensation removal is being performed, printing may not be performed properly and blank paper may be output.
- If you set to <On>, you need to keep the machine turned ON to maintain the effect of condensation removal.

### NOTE:

- The setting for <Auto Shutdown Time> is unavailable when <Control Condensation> is set to <On>.

→ Are you using the machine in an environment with high humidity?

- Change the setting for <High Humidity Mode>. Setting to <On> may solve the problem.  
▶<High Humidity Mode>(P. 478)

**NOTE:**

- If you set to <On>, the print density may vary depending on the ambient humidity.

→ Is the amount remaining in toner cartridge running low?

- Check how much the amount remaining in toner cartridges is left, and replace the toner cartridges as necessary.
- Regardless of the displayed toner level, the toner cartridge may have reached the end of its lifetime due to the machine's environmental conditions and the deteriorated materials in the cartridge. Replace the toner cartridge.  
▶Replacing the Toner Cartridge(P. 566)

Black Spots Appear



→ Have you cleaned the fixing unit?

- Clean the fixing unit.  
▶Cleaning the Fixing Assembly(P. 565)

Reverse Side of Paper is Smudged



→ Have you loaded paper that is smaller than the size of the print data?

- Check to make sure that the paper size matches the size of the print data.

→ **Have you cleaned the fixing unit?**

- Clean the fixing unit.
- ▶ **Cleaning the Fixing Assembly(P. 565)**

**Printed Barcode Cannot Be Read**



→ **Are you using a small barcode or a barcode consisting of thick lines?**

- Enlarge the barcode.
- If the direction of lines in the barcode is perpendicular to the paper output direction, turn the image 90 degrees to make the lines parallel to the paper output direction.
- If the problem persists even after performing the above operation, change the mode by using [Barcode Adjustment Mode] in the printer driver. The improvement effect is weakest with [Mode 1] and strongest with [Mode 5]. Try the adjustment starting with [Mode 1].

[Finishing] tab ▶ [Advanced Settings] ▶ [Barcode Adjustment Mode] ▶ Select the mode

**NOTE:**

- If the improvement effect is stronger, the print density becomes lighter.
- [Barcode Adjustment Mode] may not be displayed depending on the printer driver settings. For information about how to display it, see the manuals for the relevant drivers on the online manual website.
- If [Barcode Adjustment Mode] is specified, the <Correct Blurry Image> setting is disabled. In addition, specifying [Mode 4] or [Mode 5] results in slower printing.

## Paper Creases or Curls

261J-0AA

### Paper Creases



#### → Is paper loaded correctly?

- If paper is not loaded below the load limit line or is loaded obliquely, it may crease.  
▶ **Loading Paper(P. 138)**

#### → Are you using paper that has absorbed moisture?

- Replace with appropriate paper.  
▶ **Loading Paper(P. 138)**

#### → Does this problem occur when printing on plain paper or thin paper?

- Change the setting for <Paper Wrinkle Correction>. Setting to <On> may solve the problem.  
▶ **<Paper Wrinkle Correction>(P. 477)**

#### **NOTE:**

- If you set to <On>, the print may be faded or the printing speed may be slower.

#### → Are you using appropriate paper?

- Check usable paper, and replace with appropriate paper.  
▶ **Available Paper(P. 673)**  
▶ **Loading Paper(P. 138)**

### Paper Curls



### → Are you using appropriate paper?

- Check usable paper, and replace with appropriate paper. Also, specify the paper size and type settings properly.
  - ▶ **Available Paper(P. 673)**
  - ▶ **Loading Paper(P. 138)**
  - ▶ **Specifying Paper Size and Type(P. 154)**
- Change the setting for <Paper Curl Correction>. Setting to <On> may solve the problem.
  - ▶ **<Paper Curl Correction>(P. 477)**

#### **NOTE:**

- If you set to <On>, the printing speed may be slower.

### → Are you using paper that has absorbed moisture?

- Replace with appropriate paper.
  - ▶ **Loading Paper(P. 138)**
- Change the setting of <Paper Type> to a setting for thinner paper. For example, if the current setting is <Plain 1>, change it to <Thin 1>.
  - ▶ **Specifying Paper Size and Type(P. 154)**
  - ▶ **Available Paper(P. 673)**
- Change the setting for <Paper Curl Correction>. Setting to <On> may solve the problem.
  - ▶ **<Paper Curl Correction>(P. 477)**

#### **NOTE:**

- If you set to <On>, the printing speed may be slower.

## Paper Is Fed Incorrectly

261J-0AC

### Printouts Are Skewed



#### → Do the paper guides align with the edges of the paper?

- If the paper guides are too loose or too tight, the printouts are skewed.
  - ▶ **Loading Paper(P. 138)**

### Paper Is Not Fed/Two or More Sheets Are Fed Together



#### → Is paper loaded correctly?

- Fan the paper stack thoroughly so that paper is not stuck together.
- Check whether paper is loaded correctly.
  - ▶ **Loading Paper(P. 138)**
- Check whether the number of sheets of paper loaded is appropriate and whether the appropriate paper is used.
  - ▶ **Available Paper(P. 673)**
  - ▶ **Loading Paper(P. 138)**
- Check whether mixed sizes and types of paper are loaded together.
- There are cases where the paper does not load properly depending on its thickness. If this occurs, reverse the paper orientation, or flip the paper over.



## A Message or a Number Starting with "#" (an Error Code) Is Displayed

---

261J-0AE

When a message appears on the machine's display, or a number (error code) prefixed with "#" appears, see the following sections to check the solution.

- ▶ **Countermeasures for Each Message(P. 618)**
- ▶ **Countermeasures for Each Error Code(P. 632)**

## Countermeasures for Each Message

261J-0AF

If you cannot send a fax or the memory is full, or you encounter operation problems, a message appears on the display. Find out more information about messages in the following list.

A counterfeit or non-Canon cartridge may be in use. The amount in the cartridge cannot be displayed correctly.

**The toner cartridge used may not be a genuine Canon product.**

- Only genuine Canon toner cartridges should be used as replacement toner cartridges.  
▶ **Consumables(P. 586)**

An error occurred during certificate verification.

**The certificate has expired, or contains incorrect information.**

- Install the correct CA certificate.  
▶ **Registering the Key and Certificate for Network Communication(P. 385)**
- Check the certificate for validity period and domain name in the DNS settings.

Cannot analyze the authentication server certificate.

**The authentication server certificate may be invalid, or the certificate may be in a format that the printer does not support.**

- Check the authentication server certificate.  
▶ **Configuring IEEE 802.1X Authentication Settings(P. 394)**

Cannot change the destination type of destinations registered to a group.

**A selected destination could not be edited because it was registered to Group Dial.**

- To change the type of destination that is registered to Group Dial, first delete the registered destination from Group Dial. Next, change the destination type, and then register the destination to Group Dial again.

Cannot find the access point.

**When automatic setting with WPS was attempted, a wireless router could not be detected within a specific period of time.**

- Connect again paying attention to the time limit.  
▶ **Setting Up Connection Using WPS Push Button Mode(P. 20)**  
▶ **Setting Up Connection Using WPS PIN Code Mode(P. 22)**

**An SSID or network key of a wireless router was entered manually, but the entry was incorrect.**

- Check the SSID and network key, and enter the correct ones again.
  - ▶ **Checking the SSID and Network Key(P. 30)**
  - ▶ **Setting Up Connection by Specifying Detailed Settings(P. 27)**

**A wireless router could not be detected due to setting problems of the network to be connected.**

- Check whether the machine is properly installed and ready to connect to the network.
  - ▶ **Installation/Settings Problems(P. 592)**
- If the problem persists, check the security settings of the wireless router.

**Cannot print RX data.**

**Received documents cannot be printed due to some specific situation.**

- Check if there has occurred one of the following situations. If messages including causes and solutions appear on the display, check the contents.
  - A cover is open.
  - There is no paper loaded.
  - The paper is jammed.
  - The toner cartridge is consumed.
  - An error has occurred.

**Cannot receive the fax. Make sure the fax was sent correctly by the sender.**

**The recipient's machine did not respond within 35 seconds.**

- Ask the sender to send the fax again. If you hear a beep, select <Start Receiving> to receive the fax.
  - ▶ **Receiving Faxes(P. 223)**

**Cannot recognize the image.**

**An image which cannot be previewed was selected in Memory Media Print.**

- When the machine has insufficient memory space, preview cannot be displayed. Even JPEG or TIFF images may not be displayed.

**Cannot send because more than one destination is specified.**

**Sending a fax to multiple destinations is disabled.**

- To specify multiple destinations, you need to set <Restrict Sequential Broadcast> to <Off>. For more information, contact your Administrator.
  - ▶ **Restricting Sequential Broadcasts(P. 405)**

## Cannot specify group destinations, or multiple destinations at the same time.

### You specified multiple destinations or Group Dial when the receiver is off the hook.

- When the receiver is off the hook, you cannot specify multiple destinations or Group Dial. After placing the receiver on the hook, specify destinations and send fax documents.

## Cannot specify group destinations when on-hook.

### Group Dial was specified as a destination after selecting <Hook>.

- Once you select <Hook>, you cannot specify destinations in Group Dial. Specify destinations to send fax documents without selecting <Hook>.

## Cannot use these settings. Sending to the specified destination is restricted.

### The machine is set up so that the user currently logged in cannot send to the addresses registered in the selected <Favorite Settings>.

- Change the send restrictions for the logged in user.
  - ▶ **Setting the Department ID Management(P. 351)**

## Cartridge Communication Error A counterfeit or non-Canon cartridge may be in use.

### A toner cartridge may not be installed correctly or may be faulty.

- Re-install the toner cartridge. If re-installing the toner cartridge fails to clear the error message, the toner cartridge may be faulty. Contact the store where you purchased the toner cartridge or consult the Canon Customer Help Center.
  - ▶ **Procedure for Replacing the Toner Cartridge(P. 567)**

### The toner cartridge used may not be a genuine Canon product.

- Only genuine Canon toner cartridges should be used as replacement toner cartridges.
  - ▶ **Consumables(P. 586)**

## Change the authentication password.

### The password has expired.

- Set a new password.

## Check the authentication settings.

**The authentication method set on the machine does not match the authentication method set on the RADIUS server.**

- Check that the same authentication method is set on this machine and the RADIUS server, and set the correct authentication method.
  - ▶ **Configuring IEEE 802.1X Authentication Settings(P. 394)**

## Copying is restricted.

**Copying is disabled in the Department ID Management.**

- Log in with a Department ID for which copying is not disabled. For the Department ID and PIN, contact your Administrator.
  - ▶ **Setting the Department ID Management(P. 351)**

## Could not connect.

**Connection in Access Point Mode failed due to an error.**

- Wait a few moments and try again. If you still cannot connect, try switching the machine off briefly.
  - ▶ **Connecting Directly (Access Point Mode)(P. 323)**

**An error occurred when connecting in Access Point Mode.**

- Set the IP address to other than "192.168.22.xx." If you still cannot connect, check the subnet mask settings. For details, contact your Network Administrator.
  - ▶ **Setting IPv4 Address(P. 32)**

## Could not connect. Check the PSK settings.

**The network key (PSK) of a wireless router to be connected is not set to the machine correctly.**

- Check the network key (PSK) of the wireless router, and set it to the machine again.
  - ▶ **Checking the SSID and Network Key(P. 30)**
  - ▶ **Setting Up Connection by Selecting a Wireless Router(P. 24)**
  - ▶ **Setting Up Connection by Specifying Detailed Settings(P. 27)**
- If the problem persists even after checking the network key, check whether the machine is properly installed and ready to connect to the network.
  - ▶ **Installation/Settings Problems(P. 592)**

Could not connect. The maximum number of devices that can connect to the access point has been reached.

**The machine attempted to connect to a wireless LAN router to which the maximum number of devices were already connected.**

- Decrease the number of devices (clients) that are connected to the wireless LAN router. For information on the maximum number of devices that can connect, see the instruction manual for the wireless LAN router or contact the manufacturer.

Could not connect using Easy Connection via PC. The device will restart.

**Connection in Access Point Mode failed due to an error.**

- Restart the machine, and then, perform <Easy Connection via PC> again.  
 **<Easy Connection via PC> (P. 459)**

**An error occurred during the procedure for Easy Connection via PC (cableless setup mode).**

- Restart the machine, and then, perform <Easy Connection via PC> again.  
 **<Easy Connection via PC> (P. 459)**

Could not connect using the wireless LAN. Turn the main power OFF and ON, then configure the settings again.

**A connection failed due to an error while setting wireless LAN connection.**

- Restart the machine and set again.
- If the problem persists even after restarting the machine, check whether the machine is properly installed and ready to connect to the network.  
 **Installation/Settings Problems(P. 592)**
- If the problem persists even after checking the wireless LAN connection, check the security settings of the wireless router.

Could not connect using WPS. Wait a moment, then configure the settings again.

**When automatic setting with WPS was attempted, the connection failed due to an error.**

- Wait for a while, and set again. If the problem persists, check whether the wireless router supports WPS.

**If WPS is supported:**

Check whether the machine is properly installed and ready to connect to the network.

 **Installation/Settings Problems(P. 592)**

**If WPS is not supported:**

Set using another connecting method.

 **Connecting to a Wireless LAN(P. 18)**

## Could not detect any connections from wireless devices.

### Mobile device detection was not possible within the predetermined length of time.

- Connect again paying attention to the time limit.
  - ▶ **Connecting Directly (Access Point Mode)(P. 323)**

## Could not perform cleaning.

### Paper jammed during cleaning.

- Remove the jammed paper, set paper correctly, and perform cleaning again.
  - ▶ **Clearing Paper Jams(P. 642)**
  - ▶ **Cleaning the Feeder(P. 562)**
  - ▶ **Cleaning the Fixing Assembly(P. 565)**

### The amount remaining in toner cartridges required for cleaning the fixing assembly is insufficient.

- Cleaning requires sufficient toner cartridge remaining. Replace the toner cartridge, and perform the cleaning again.
  - ▶ **Procedure for Replacing the Toner Cartridge(P. 567)**

## Could not perform correction.

### Appropriate paper that is required for correction is not loaded in a paper drawer.

- Load the paper matching the paper specification displayed on the screen into the paper drawer.
  - ▶ **Adjusting the Gradation and Density for Copy Jobs(P. 573)**

### An adjustment image that is required for correction is not placed on the platen glass correctly.

- Place the adjustment image printed paper with the print side facing down and with the thin black line on the left.
  - ▶ **Adjusting the Gradation and Density for Copy Jobs(P. 573)**

### Paper jammed during correction.

- Remove the jammed paper, and perform correction again.
  - ▶ **Clearing Paper Jams(P. 642)**

### The amount remaining in toner cartridges required for correction is insufficient.

- Corrections require sufficient toner cartridge remaining. Replace the toner cartridge, and perform correction again.
  - ▶ **Procedure for Replacing the Toner Cartridge(P. 567)**

## Could not perform Open System authentication. Check the WEP settings.

### The authentication method of the machine is set to <Open System>, but that of a wireless router is set to "Shared Key."

- Connect again by manually changing the WEP authentication method to <Shared Key>.

▶ **Setting Up Connection by Specifying Detailed Settings(P. 27)**

**The MAC address of the machine is rejected because the MAC address filter is set at a wireless router.**

- Set the wireless router to permit the MAC address of the machine and your computer. For more information about how to set, see the instruction manuals for your networking devices or contact your manufacturer. To check the MAC address of the machine, select <Menu> ▶ <Preferences> ▶ <Network> ▶ <Wireless LAN Settings> ▶ <Connection Information>.
- ▶ **Viewing the MAC Address for Wired LAN(P. 38)**

**Could not perform Shared Key authentication. Check the WEP settings.**

**The network key (the WEP key) of a wireless router to be connected is not set to the machine correctly.**

- Check the network key (the WEP key) of the wireless router, and set it to the machine again.
  - ▶ **Checking the SSID and Network Key(P. 30)**
  - ▶ **Setting Up Connection by Specifying Detailed Settings(P. 27)**
- Connect again by selecting a wireless router or by manually changing the WEP authentication method to <Open System>.
  - ▶ **Setting Up Connection by Selecting a Wireless Router(P. 24)**
  - ▶ **Setting Up Connection by Specifying Detailed Settings(P. 27)**

**The authentication method of the machine is set to <Shared Key>, but that of the wireless router is set to "Open System."**

- Change the WEP authentication method to "Shared Key" at the wireless router, and connect again. For more information about how to change, see the instruction manuals for your networking devices or contact your manufacturer.

**Direct Connection terminated.**

**Connection with the mobile device was interrupted.**

- Establish Direct Connection again.
  - ▶ **Connecting Directly (Access Point Mode)(P. 323)**

**Easy Connection via PC ended due to timeout The device will restart.**

**30 minutes have passed since the start of the procedure for Easy Connection via PC (cableless setup mode), but PC still cannot be connected.**

- Restart the machine, and then, perform <Easy Connection via PC> again.
  - ▶ **<Easy Connection via PC> (P. 459)**

**End of cartridge lifetime.**

**The toner cartridge has reached the end of its lifetime.**

- Replacement of the toner cartridge is recommended.
  - ▶ **Procedure for Replacing the Toner Cartridge(P. 567)**



## Faxing is restricted.

### Faxing is disabled in the Department ID Management.

- Log in with a Department ID for which faxing is not disabled. For the Department ID and PIN, contact your Administrator.
  - ▶ **Setting the Department ID Management(P. 351)**

## Google Cloud Print Authentication Error

### Cloud Print could not perform server authentication, or could not acquire information for registration.

- Check whether the date and time settings are correctly specified.
  - ▶ **<Date/Time Settings>(P. 452)**

## Google Cloud Print Communication Error

### Cloud Print is unavailable due to an error.

- Check whether the machine is correctly connected to a wireless LAN or wired LAN.
  - ▶ **Connecting to a Wireless LAN(P. 18)**
  - ▶ **Connecting to a Wired LAN(P. 17)**
- A port that is used for Cloud Print may be blocked by a firewall or other protection. Check whether the 5222 port is available with your computer.
- If a proxy server is used on the network, check whether the proxy settings on the machine and the server are correct. For details, contact your Network Administrator.
  - ▶ **Setting a Proxy(P. 374)**

## Load paper.

### Paper is not loaded in the paper drawer or the multi-purpose tray.

- Load the paper.
  - ▶ **Loading Paper(P. 138)**

### Paper on which reports or lists can be printed is not loaded.

- Load appropriate paper for printing reports or lists, and make settings for paper size and paper type.
  - ▶ **Loading Paper(P. 138)**
  - ▶ **Specifying Paper Size and Type(P. 154)**
  - ▶ **Available Paper(P. 673)**

### Paper on which received documents can be printed is not loaded.

- Load appropriate paper for printing the received document, and make settings for paper size and paper type.
  - ▶ **Loading Paper(P. 138)**
  - ▶ **Specifying Paper Size and Type(P. 154)**
  - ▶ **Available Paper(P. 673)**

**NOTE:**

- If you print received documents on paper other than A4 or Letter size, some portions of the image may be missing or the image may be divided and printed onto several sheets.

## Memory Full (Secure Print)

**Memory became full of secured documents that were not printed.**

- Print the secured documents that are stored in memory.
  - ▶ **Printing via Secure Print(P. 262)**

## Memory Full (Skip Error)

**The memory became full of print data that could not be printed due to errors.**

- Cancel printing of documents to which an error has occurred, or print the documents by selecting <Skip Error> on the screen for checking the printing status.
  - ▶ **Canceling Prints(P. 256)**

## Memory Media Print is restricted.

**The function that prints files in a USB memory device is disabled.**

- Set <Use Print Function> in <Memory Media Settings> to <On>.
  - ▶ **Restricting the USB Print Function(P. 408)**

## No reply from the destination.

**A LAN cable may be disconnected, or there may be a problem in a switch.**

- Check the status of the LAN cables and switches.

## No response from the host.

**The machine is not connected to a network correctly.**

- Check the machine and network settings, and connect again.
  - ▶ **Setting Up the Network Environment(P. 14)**

## Paper jammed.

**Paper jams.**

- Remove the jammed paper, and print again (Printing may resume automatically).

▶ **Clearing Paper Jams(P. 642)**

## Paper Settings and Loaded Size Mismatch

**The paper size setting on the operation panel does not match the loaded paper size.**

- Match the paper size setting specified in <Paper Settings> and the size of the paper that is actually loaded.

**To use the loaded paper**

Change the setting of <Paper Settings> to match the loaded paper size.

▶ **Specifying Paper Size and Type(P. 154)**

**NOTE:**

- If printing from a computer, check whether the paper size setting in the printer driver matches the loaded paper size.

**To load paper without changing the settings**

Load the paper with the size that is set to <Paper Settings>.

▶ **Loading Paper(P. 138)**

- Check that the paper guides in the paper drawer are set in the correct position.

▶ **Loading Paper(P. 138)**

## Prepare cartridge.

**Toner cartridge replacement time is near.**

- Make sure that you have a replacement toner cartridge ready. Replace the toner cartridge if you see this message before you start to print a large job.

▶ **Consumables(P. 586)**

**NOTE:**

- When copying or printing, you can continue printing the original.
- If a message is displayed when the machine is receiving a fax or automatic report output is set, received faxes and reports will be stored in memory so that they do not appear faded after they are printed. To continue printing even if the amount remaining in toner cartridge is running low, set <Continue Print. When Cart. Low> to <On>. ▶ **<Continue Print. When Cart. Low> (P. 530)**

## Printing is restricted.

**Printing is disabled in the Department ID Management.**

- Log in with a Department ID for which printing is not disabled. For the Department ID and PIN, contact your Administrator.

▶ **Setting the Department ID Management(P. 351)**

## Remote scanning is restricted.

**Scanning that is operated by using a computer is disabled in the Department ID Management.**

- Log in to the Remote UI in System Manager Mode, display the edit screen of Department ID Management, and select the [Allow Scan Jobs with Unknown IDs] check box.  
 ▶ **Setting the Department ID Management(P. 351)**

## Scanning is restricted.

**Scanning is disabled in the Department ID Management.**

- Log in with a Department ID for which scanning is not disabled. For the Department ID and PIN, contact your Administrator.  
 ▶ **Setting the Department ID Management(P. 351)**

## Set the correct authentication information.

**The client authentication information (key and certificate, user name and password, or CA certificate) is not set correctly.**

- Check the specified authentication method and authentication information (key and certificate, user name and password, and CA certificate).  
 ▶ **Configuring IEEE 802.1X Authentication Settings(P. 394)**

## Set the information necessary for authentication.

**The IEEE 802.1X authentication has not been configured correctly.**

- Configure the IEEE 802.1X correctly from the Remote UI.  
 ▶ **Configuring IEEE 802.1X Authentication Settings(P. 394)**

## Specifying and registering new destinations is restricted.

**Only destinations that are registered in the Address Book can be specified to send a fax or e-mail.**

- To enter a new destination with the operation panel, or add or edit it in the Address Book, you need to set <Restrict New Destinations> to <Off>. For more information, contact your Administrator.  
 ▶ **Restricting New Destinations that Can Be Specified(P. 403)**

## The authentication server certificate has expired.

**The server certificate sent from the RADIUS server has expired.**

- Check the valid period of the server certificate on the RADIUS server.

▶ **Configuring IEEE 802.1X Authentication Settings(P. 394)**

## The authentication server certificate is incorrect.

**There is no CA certificate registered in the printer that is compatible with the authentication server certificate.**

- Check that there is a CA certificate registered in the printer that is compatible with the authentication server certificate.
- ▶ **Configuring IEEE 802.1X Authentication Settings(P. 394)**

## The computer is restricted.

**Scanning that is operated on the operation panel is disabled in the Department ID Management.**

- Log in to the Remote UI in System Manager Mode, display the edit screen of the corresponding Department ID, and select the [Allow Scan Jobs with Unknown IDs] check box.
- ▶ **Setting the Department ID Management(P. 351)**

## The fax number has too many digits.

**A fax could not be sent because the specified destination fax number had too many digits.**

- Specify the destination fax number which does not exceed the maximum number of digits allowed.
- ▶ **<Use Addr. Book When On-Hook>(P. 527)**

## The memory is full.

**A fax could not be sent or received, or an original could not be scanned due to insufficient memory space.**

- If a sending or printing job is queued, wait until the job is completed.
  - If a received document is stored to memory, print or delete it.
- ▶ **Saving Received Documents into the Machine (Memory Reception)(P. 234)**
- If sending an original with many pages, divide it into multiple sections.
  - If sending a fax, reduce the resolution to scan the original.
- ▶ **Basic Operations for Sending Faxes(P. 214)**
- If scanning, change the file format to reduce its file size.
- ▶ **Basic Operations for Scanning Originals(P. 279)**

**A scanned original could not be stored to a USB memory device due to insufficient memory space.**

- Delete unnecessary data to free space in the USB memory device, or connect a different USB memory device.
- ▶ **Using a USB Memory Device(P. 184)**

## The memory is full. Enter the original type settings again.

**An original could not be scanned because memory became full during copying.**

- Set <Original Type> to <Text/Photo>, and copy.  
 ▶ **Selecting the Type of Original for Copying(P. 200)**

## The memory is full. Scanning will be canceled. Do you want to print?

**An original could not be scanned due to insufficient memory space.**

- Select whether to print the pages that were scanned or cancel the job.
- Copy the original in two or more parts.

**Not all of the pages could be scanned during sorting and copying.**

- Select whether to print the pages that were scanned or cancel the job.
- If this is a copy job, either copy the original in two or more parts or change the <Original Type> setting to <Text/Photo> and then copy the original.  
 ▶ **Selecting the Type of Original for Copying(P. 200)**

## The number of entered characters is incorrect or invalid characters are used.

**The network key (the WPA/WPA2-PSK or WEP key) of a wireless router is not entered correctly.**

- Check the network key (the WPA/WPA2-PSK or WEP key) of the wireless router, and set it to the machine again. For more information about how to check the network key, see the instruction manuals for your networking devices or contact your manufacturer.  
 ▶ **Checking the SSID and Network Key(P. 30)**  
 ▶ **Setting Up Connection by Selecting a Wireless Router(P. 24)**  
 ▶ **Setting Up Connection by Specifying Detailed Settings(P. 27)**

## The USB memory is restricted.

**The function that stores a scanned original to a USB memory device is disabled.**

- Set <Use Scan Function> to <On>.  
 ▶ **Restricting the Scan to USB Function(P. 408)**

## The WEP key is not set correctly. Check the WEP settings.

**The network key (the WEP key) of a wireless router to be connected is not set to the machine correctly.**

- Check the network key (the WEP key) of the wireless router, and set it to the machine again.  
 ▶ **Checking the SSID and Network Key(P. 30)**  
 ▶ **Setting Up Connection by Selecting a Wireless Router(P. 24)**  
 ▶ **Setting Up Connection by Specifying Detailed Settings(P. 27)**

**The authentication method of the machine is set to <Shared Key>, but that of the wireless router is set to "Open System."**

- Connect again by selecting a wireless router or by manually changing the WEP authentication method to <Open System>.
  - ▶ **Setting Up Connection by Selecting a Wireless Router(P. 24)**
  - ▶ **Setting Up Connection by Specifying Detailed Settings(P. 27)**
- Change the WEP authentication method to "Shared Key" at the wireless router, and connect again. For more information about how to change, see the instruction manuals for your networking devices or contact your manufacturer.

**Use Remote UI to set the information necessary for authentication.**

**The IEEE 802.1X settings are incorrect.**

- Check whether [Login Name] is set correctly.
- Check whether the [Use TLS], [Use TTLS], or [Use PEAP] check box is selected.
- If using TLS, check whether a "key and certificate" is registered.
- If using TTLS or PEAP, check whether a user name and password are set correctly.
  - ▶ **Configuring IEEE 802.1X Authentication Settings(P. 394)**

# Countermeasures for Each Error Code

261J-0AH

If an error occurs such as when printing is not successful or when you cannot send or receive a fax or scanned original, the corresponding error code is displayed in a report or in the job log screen as a three-digit number. Check the following to find out causes and solutions for each error code. For how to print an error report and information in the report, see [▶Printing Reports and Lists\(P. 581\)](#) . For details of the job log screen, see [▶<Status Monitor> Screen\(P. 124\)](#) .

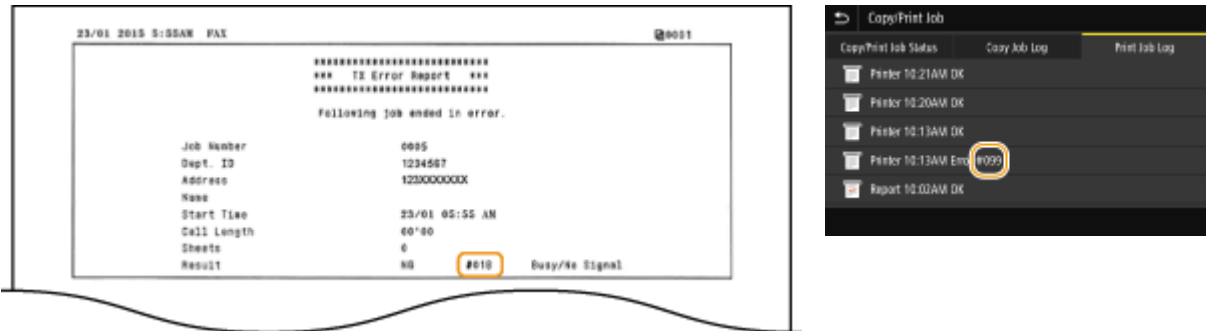

## #001

**An original jams in the feeder.**

- Remove the jammed original.
  - [▶Paper Jams in the Feeder\(P. 644\)](#)

## #003

**A fax could not be sent or received due to its large data size.**

- When sending a fax: Reduce the resolution, and scan the original.
  - [▶Basic Operations for Sending Faxes\(P. 214\)](#)
- When receiving a fax: Ask the sender to divide the original into multiple sections or reduce the resolution before sending.

## #005

**A fax could not be sent because the recipient's machine did not respond within 35 seconds.**

- When the recipient's machine is turned OFF or the line is busy, a fax may not be sent. Ask the recipient to check the machine status. When sending the fax overseas, insert pauses in the fax number.
  - [▶Basic Operations for Sending Faxes\(P. 214\)](#)

## #012

**A fax could not be sent because the recipient's machine ran out of paper.**



- Ask the recipient to reload the paper.

## #018

### A fax could not be sent since the recipient's machine did not respond because the line was busy or for other reasons.

- When the recipient's machine is turned OFF or the line is busy, a fax may not be sent. Ask the recipient to check the machine status. When sending the fax overseas, insert pauses in the fax number.
  - ▶ **Basic Operations for Sending Faxes(P. 214)**

## #022

### Sending of a fax from a computer is disabled.

- To send a fax from a computer, you need to set <Allow Fax Driver TX> to <On>. For more information, contact your Administrator.
  - ▶ **Restricting Fax Sending from a Computer(P. 405)**

### A fax could not be forwarded because the specified destination was deleted from the Address Book.

- Register the forwarding destination again. If the documents that failed to be forwarded remain in memory, you can forward it again.
  - ▶ **Registering Destinations(P. 176)**
  - ▶ **Printing/Resending/Deleting Documents that Failed to be Forwarded(P. 236)**

## #037

### A document could not be sent because the memory was full.

- If a job queued, wait until the job is completed.
- If a received document is stored to memory, print or delete it.
  - ▶ **Saving Received Documents into the Machine (Memory Reception)(P. 234)**
- If sending an original with many pages, divide it into multiple sections.
- If sending a fax, reduce the resolution to scan the original.
  - ▶ **Basic Operations for Sending Faxes(P. 214)**

### PC faxing failed because the number of destinations specified for simultaneous transmission exceeded the maximum value.

- Clear the [Set the number of destinations that can be specified at once to 2000] check box in the fax driver. Open the printer folder ( ▶ **Displaying the Printer Folder(P. 698)** ) ▶ Right-click the fax driver icon for this machine ▶ [Printer properties] or [Properties] ▶ [Device Settings] tab ▶ [Detailed Settings]

### The file is too large to print.

- Optimize the file to reduce the size or divide the file into sections, and then proceed to printing again.
- Try printing from the printer driver. This may work well.

## #099

### An operation that caused a job to be canceled has been performed.

- When you cancel a job, this error code is displayed, but this is not abnormal. Print, send, or receive documents again as necessary.

## #401

### A scanned original could not be stored to a USB memory device due to insufficient memory space.

- Delete unnecessary data to free space in the USB memory device, or connect a different USB memory device.
  - ▶ **Using a USB Memory Device(P. 184)**

## #406

### A scanned document could not be stored to a USB memory device due to an error.

- Remove the USB memory device, and connect it again.
  - ▶ **Using a USB Memory Device(P. 184)**
- Reduce the number of originals to scan.

## #408

### Read failed because the USB memory device was removed while data was being read from it.

- Check that the USB memory device has not been removed and then read the data again.
  - ▶ **Using a USB Memory Device(P. 184)**
  - ▶ **Printing from a USB Memory Device (Memory Media Print)(P. 265)**

### The connected USB memory device is using an unsupported format.

- Check that the USB memory device is using a format supported by this machine.
  - ▶ **Using a USB Memory Device(P. 184)**

## #701

### Authentication failed because an incorrect Department ID or PIN was entered when the Department ID Management was activated.

- Enter the correct Department ID and PIN.

### Continuing operating without entering a Department ID was attempted even though unknown-ID jobs (functions that permit operations without a Department ID and PIN) were disabled in the Department ID Management.

- Enable unknown-ID jobs in System Manager Mode in Remote UI.

▶ **Blocking Jobs When Department ID Is Unknown(P. 355)**

#703

**Data could not be written because the memory space that was allocated for images was full when sending an e-mail/I-Fax or storing to a shared folder/FTP server.**

- If another sending document is queued, wait for a while until it is completed, and send again.
- Divide the document into multiple sections before sending.
- Delete the documents that are stored in memory.
- Turn OFF the machine, wait for at least 10 seconds, and turn it back ON.

#751

**The FTP server has not been started up or a network connection has been cut.  
(Failure to connect to the destination is sometimes caused by a disconnection en route.)**

- Check the destination.
- Check the network status.
  - ▶ **Viewing Network Settings(P. 38)**

**The IP address was not set correctly.**

- Check <TCP/IP Settings>.
  - ▶ **Setting IP Addresses(P. 31)**

#752

**E-mail sending or I-Fax sending/receiving was impossible because an incorrect SMTP/POP3 server name was set.**

- Check the SMTP/POP3 server name, and correct the setting.
  - ▶ **Configuring Basic E-Mail Settings(P. 87)**
  - ▶ **Configuring E-Mail/I-Fax Communication Settings(P. 90)**

**E-mail sending or I-Fax sending/receiving was impossible because an incorrect domain name was set.**

- Check the domain name, and correct the setting.
  - ▶ **Configuring DNS(P. 56)**

**E-mail sending or I-Fax sending/receiving was impossible because the machine was not connected to a network correctly.**

- Check whether the machine is properly installed and correctly connected to the network.
  - ▶ **Installation/Settings Problems(P. 592)**

#753

**Scanned data could not be sent as e-mail, not sent/received as I-Fax, or not stored in the shared folder/FTP server because the LAN cable is disconnected.**

- Check whether the LAN cable is connected correctly.  
 ▶ **Connecting to a Wired LAN(P. 17)**

## #755

**Scanned data could not be sent as e-mail or I-Fax nor stored in the shared folder or FTP server because TCP/IP was not working correctly.**

- Check <TCP/IP Settings>, and set correctly.  
 ▶ **<Network>(P. 457)**

**An IP address is not set.**

- Set the IP address correctly.  
 ▶ **Setting IP Addresses(P. 31)**

**The machine cannot communicate with devices on a network immediately after the machine starts up because the waiting time for the start of the communication is set.**

- The machine cannot start communicating immediately after it is turned ON. Wait until the set time for <Wait Time for Conn. at Startup> passes after turning ON the machine, and send again.  
 ▶ **Setting a Wait Time for Connecting to a Network(P. 55)**

## #766

**The certificate has expired.**

- Update the certificate or use a certificate that has not expired.
- Check that the <Current Date/Time Settings> are correct.  
 ▶ **Setting the Date/Time(P. 12)**

## #801

**When communicating with an SMTP server to send an e-mail/I-Fax, a timeout error occurred from the server.**

- Check whether SMTP is running on the network correctly.
- Check whether the machine is properly installed and correctly connected to the network.  
 ▶ **Installation/Settings Problems(P. 592)**

**When communicating with the SMTP server, an error returned from the server.**

- Check whether the SMTP server is set correctly.

**A destination is not set correctly.**

- Check whether the destination is set correctly.

**When storing a scanned original into the shared folder, an error occurred from the folder.**

- Check whether the shared folder and the computer that has the shared folder are running correctly.

**The incorrect folder name or password was specified when storing to the shared folder.**

- Check the destination settings.

## #802

### The SMTP/POP3/FTP server name is not set correctly.

- Set the SMTP/POP3/FTP server name correctly.
  - ▶ **Configuring Basic E-Mail Settings(P. 87)**
  - ▶ **Configuring E-Mail/I-Fax Communication Settings(P. 90)**
  - ▶ **Registering Destinations from Remote UI(P. 427)**

## #804

### No access privileges to access the shared folder/FTP server are granted.

- Assign the privilege for writing data to the storage folder to the sender (user name registered in the destination). For details, contact your Network Administrator.

### The incorrect folder name was specified when storing to the shared folder/FTP server.

- Check the destination settings.

## #806

### When storing data to a shared folder/FTP server, an incorrect user name or password was specified.

- The same user name and password as those registered in a shared folder/FTP server must be registered in the Address Book.
  - ▶ **Setting a Shared Folder as a Save Location(P. 95)**
  - ▶ **Registering Destinations from Remote UI(P. 427)**

### When sending an e-mail/I-Fax, an incorrect destination was specified.

- Enter the correct e-mail address, and send the message again. If the destination that was registered in the Address Book was used, check whether the e-mail address is correct.
  - ▶ **Registering Destinations(P. 176)**

## #808

### An error or timeout occurred on the FTP server.

- Check the FTP server settings.
  - ▶ **Registering Destinations from Remote UI(P. 427)**

## #810

### An error has been returned from the POP3 server when sending an e-mail or sending/receiving I-Fax.

- Check whether the POP3 server is set correctly.

- Check whether your mail server and network are running correctly. For more information, contact your Network Administrator.

## #813

**The login name or the password that is used on the POP3 server is not set correctly.**

- Correctly enter the login name or the password that is used on the POP3 server.

## #816

**The number of print pages has reached the upper limit specified for the department.**

- To reset the print page count, click [Clear Count] on the [Department ID Management] page of Remote UI.  
▶ **Registering/Editing Department ID and PIN(P. 351)**

## #818

**The received data is in a file format that the machine cannot print.**

- Contact the other party and ask them to resend the data in a different file format.

## #819

**The received data is not supported (incorrect MIME information).**

- Contact the other party and ask them to check the settings and then resend the data.

## #820

**The received data is not supported (incorrect BASE64 or uuencode information).**

- Contact the other party and ask them to check the settings and then resend the data.

## #821

**The received data is not supported (a TIFF analysis error occurred).**

- Contact the other party and ask them to check the settings and then resend the data.

## #822

**An file in a USB memory device could not be printed because the format of the file is not supported.**

- Check the supported file formats and save the file again.  
 ▶ **Printer Functions(P. 680)**

## #827

### The received data is not supported (includes unsupported MIME information).

- Contact the other party and ask them to check the settings and then resend the data.

## #829

### The received data exceeds the maximum receivable size.

- In fax reception, the machine deletes the data for page 1,000 onwards and either prints the first 999 pages or holds them in memory. Get the sender to resend page 1,000 onwards.
- In I-Fax reception, the machine cannot receive the e-mail if its size exceeds 24 MB. Ask the sender to reduce the size of the e-mail down to under 24 MB and try resending.

## #839

### A user name and password that are used for SMTP authentication are not set correctly.

- Set the user name and password correctly.  
 ▶ **Configuring Basic E-Mail Settings(P. 87)**  
 ▶ **Configuring E-Mail/I-Fax Communication Settings(P. 90)**

## #841

### When sending an e-mail/I-Fax, an encryption algorithm that is common to the mail server is not present.

- Clear the [Use TLS for SMTP]/[Use TLS for POP] check box.  
 ▶ **Configuring E-Mail/I-Fax Communication Settings(P. 90)**
- Add the common encryption algorithm to the mail server settings.

### A TLS server certificate verification error has occurred during communication with the SMTP server.

- Check that the CA certificate that signed the TLS server certificate on the SMTP server side is registered to the machine by using the Remote UI.
- Check that the TLS server certificate on the SMTP server side is valid.
- Check that the TLS server certificate is not a self-signed one.

## #844

### TLS encrypted communication to a POP3 server failed when sending an e-mail with POP before SMTP.

- Check the TLS encrypted communication settings in the POP3 server.

- Clear the [Use TLS for POP] check box. If the problem persists, clear the [Use POP Authentication Before Sending] check box, and set the communication setting to a setting other than POP before SMTP.  
 ▶ **Configuring E-Mail/I-Fax Communication Settings(P. 90)**

**When verifying an TLS server certificate to communicate to the POP3 server, a verification error occurred.**

- Check that the CA certificate that signed the TLS server certificate on the POP3 server side is registered to the machine by using the Remote UI.
- Check that the TLS server certificate on the POP3 server side is valid.
- Check that the TLS server certificate is not a self-signed certificate.

#846

**An e-mail or I-Fax could not be sent due to a POP authentication failure.**

- Check the setting, and try again.  
 ▶ **Configuring E-Mail/I-Fax Communication Settings(P. 90)**

#852

**The machine turns OFF for some reason.**

- Check whether the power plug is inserted into an outlet firmly.

#853

**A document could not be printed because its data size exceeded the machine's upper processing capability.**

- The machine may not be able to print documents with many pages. Reduce the number of pages per printing, or print when no print job is queued or no document is being printed. If you are still unable to print, check the document data for any defects.

**Printing was canceled from the computer.**

- If you cancel an operation when the print data is being sent to the machine from a computer, this error code is displayed, but this is not abnormal. Print again as necessary.

**A secured document that was left unprinted was deleted.**

- If the secured document is not printed within a specific period of time (30 minutes by default), it is deleted from memory. Send the secured document again, and print it within the period.  
 ▶ **Printing via Secure Print(P. 262)**

**Printing using Secure Print was attempted when Secure Print was restricted.**

- When <Secure Print> is set to <Off>, you cannot use Secure Print. Set the setting to <On> and print again.  
 ▶ **Printing via Secure Print(P. 262)**
- Print without using Secure Print.  
 ▶ **Basic Printing Operations(P. 254)**

**You tried to print a file that is either corrupted or not supported.**



- Check the file and try again.  
▶ **Basic Printing Operations(P. 254)**

**Password protected PDF files could not be printed.**

- Enter the correct password for the PDF file.  
▶ **Printing from a USB Memory Device (Memory Media Print)(P. 265)**

## #861

**A document could not be printed because a printer driver that was not intended for this machine was used.**

- Print again by using the printer driver for this machine.  
▶ **Basic Printing Operations(P. 254)**

**A document could not be printed due to a defect in its data.**

- Check the document data for any defects.

## #863

**An error occurred when printing from a computer.**

- Turn OFF the machine, wait for at least 10 seconds, and turn it back ON. After the restart is complete, try printing again.

## #995

**A document waiting to be sent or received was canceled.**

- Send or receive the document again as necessary.

# Clearing Paper Jams

261J-0AJ

If a paper jams, <Paper jammed.> is displayed on the screen. Select <Next> to display simple solutions. If it is difficult to understand the procedures on the display, see the following sections to clear jams.

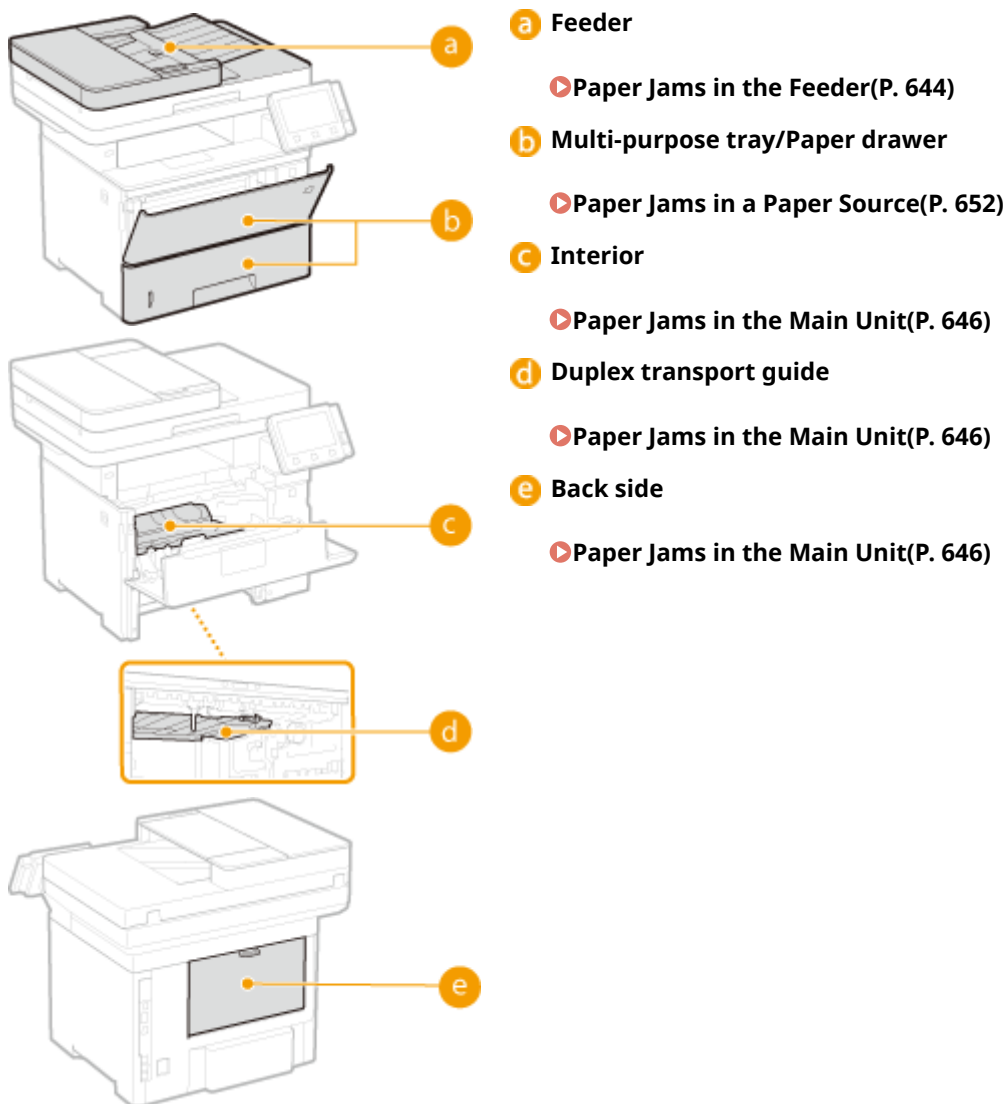
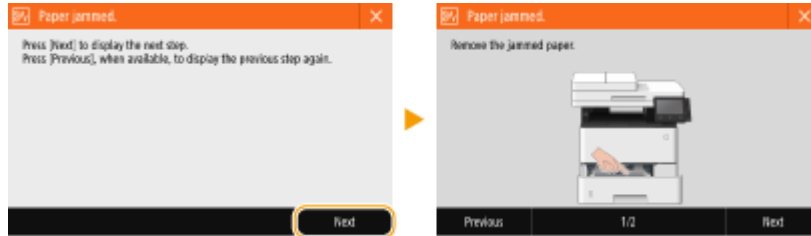

## IMPORTANT

### When removing the jammed paper, do not turn OFF the machine

- Turning OFF the machine deletes the data that is being printed. Be especially careful when receiving fax documents.

### **If paper tears**

- Remove all the paper fragments to prevent them from becoming jammed.

### **If paper jams repeatedly**

- Tap the paper stack on a flat surface to even the edges of the paper before loading it into the machine.
- Check that the paper is appropriate for the machine. ▶ **Available Paper(P. 673)**
- Check that no jammed paper fragments remain in the machine.

### **Do not forcibly remove the jammed paper from the machine**

- Forcibly removing the paper may damage parts. If you are not able to remove the paper, contact your local authorized Canon dealer or the Canon help line. ▶ **When a Problem Cannot Be Solved(P. 654)**

# Paper Jams in the Feeder

261J-0AK

If there are originals placed in the feeder, remove them first. Then, follow the procedure below. Do not forcibly remove jammed paper from the machine. If the jammed paper cannot be removed easily, proceed to the next step.

## 1 Remove the jammed original from the feeder cover.

- 1 Open the feeder cover.

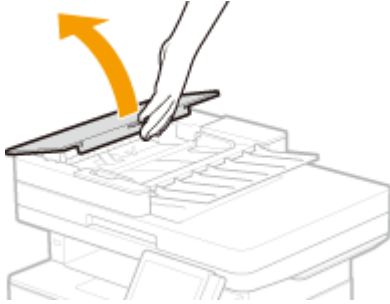

- 2 Gently pull out the original.

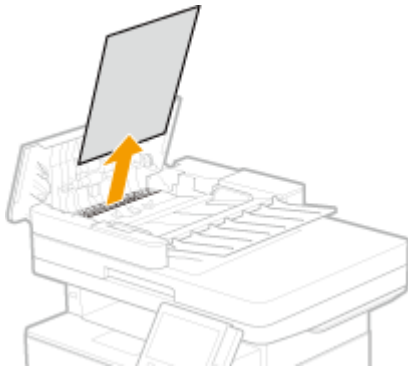

- 3 Lift the original tray, and gently pull out the original.

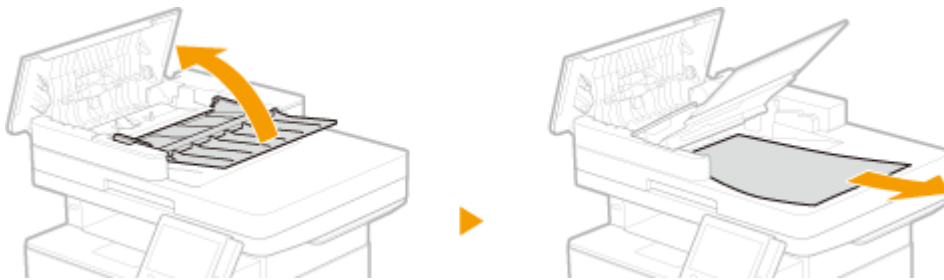

- 4 Close the feeder cover.

## 2 Remove the jammed original from the underside of the feeder.

- 1 Open the feeder.

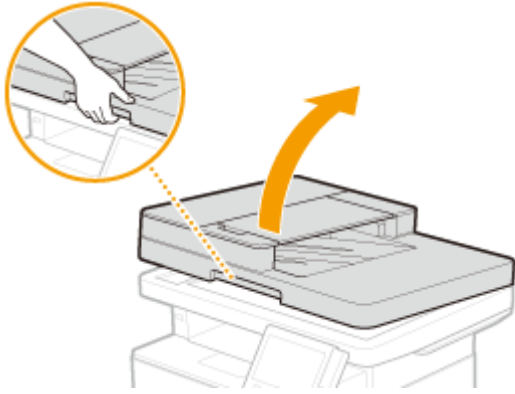

**2** Gently pull out the original.

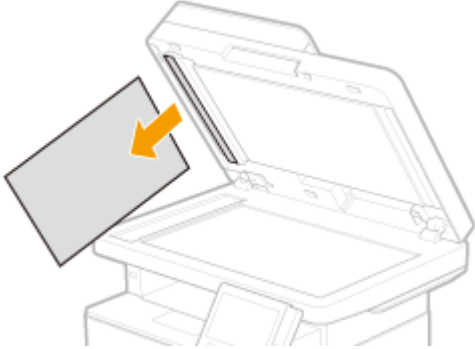

**3** Gently close the feeder.

**3** Place the original again.

# Paper Jams in the Main Unit

261J-0AL

Remove the jammed paper according to the procedure that matches the location at which a paper jam occurred.

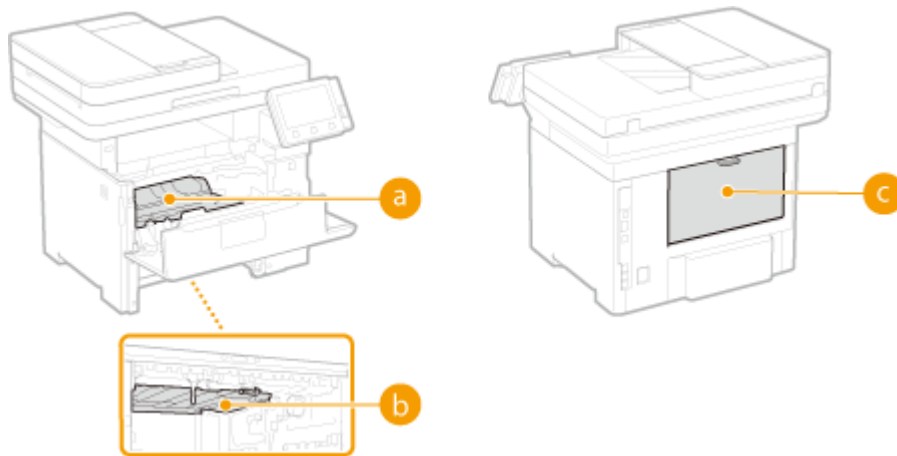

**a Interior**

▶ Paper Jams inside the Machine or in the Back Side(P. 646)

**b Duplex transport guide**

▶ Paper Jams at the Duplex Transport Guide(P. 649)

**c Back side**

▶ Paper Jams inside the Machine or in the Back Side(P. 646)

## Paper Jams inside the Machine or in the Back Side

If the jammed paper cannot be removed easily, do not try to forcibly remove it but instead proceed to the next step.

**1 Open the front cover.**

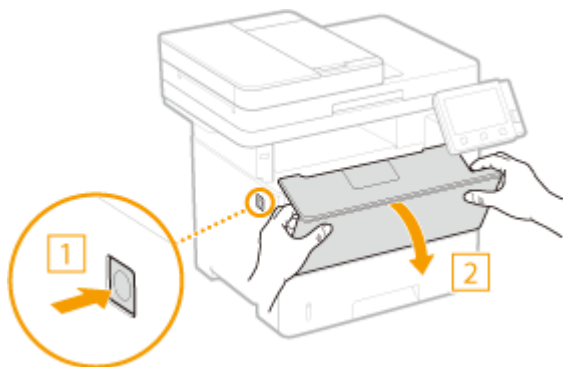

**2 Remove the toner cartridge.**

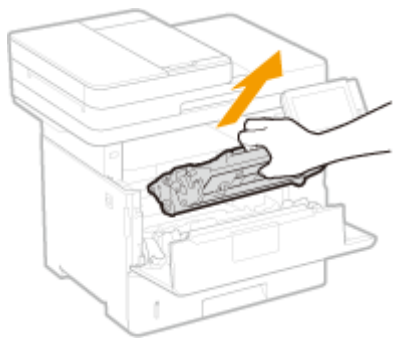

**3 Hold the front side green knob and lift the transport guide.**

- Keep holding the transport guide until returning it to the original position in step 5.

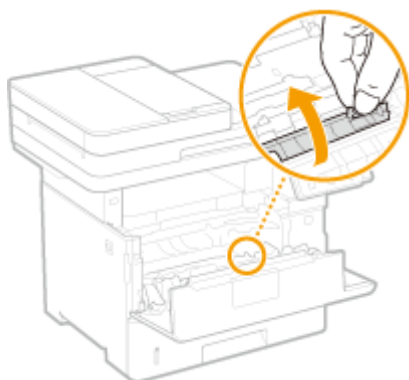

**4 Gently pull out the paper.**

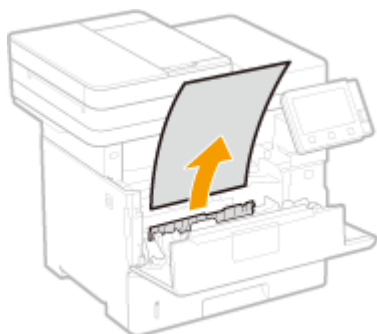

**5 Gently return the transport guide back in place.**

**6 Hold the front side green knob and lift the transport guide.**

- Keep holding the transport guide until returning it to the original position in step 8.

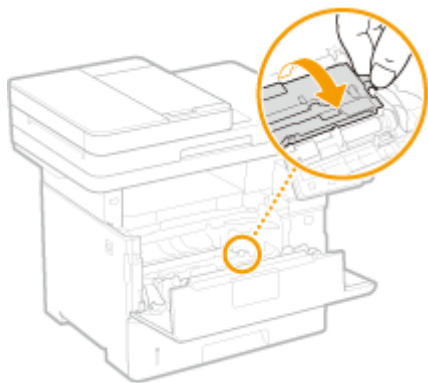

**7 Gently pull out the paper.**

- Pull out the paper flatly as much as possible to prevent unfixed toner from being dropped.

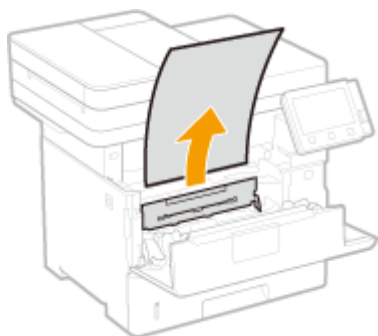

**8 Gently return the transport guide back in place.**

**9 Open the rear cover.**

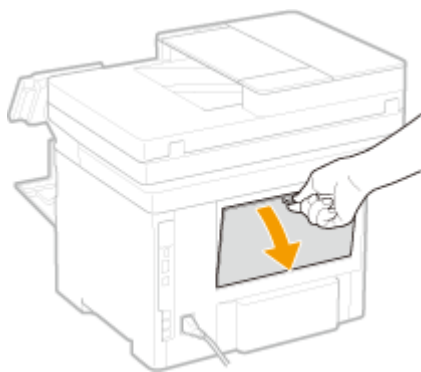

**10 Gently pull out the paper.**

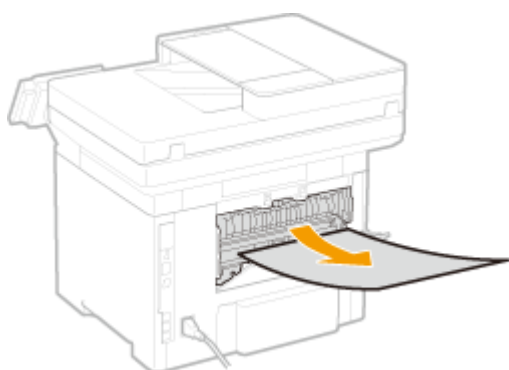



**11 Close the rear cover.**

**12 Install the toner cartridge.**

- Make sure to push in the cartridge until it stops.

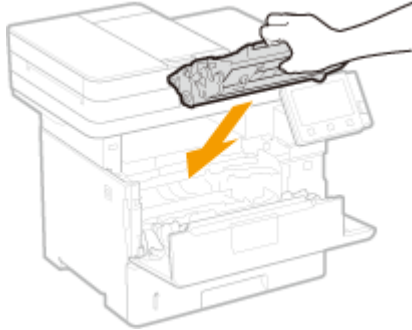

**13 Close the front cover.**

**NOTE:**

**When the message is still displayed**

- Paper may be jammed in other locations. Check other locations, and remove jammed paper if any. If the message is still displayed, check whether the front cover is securely closed.

**Paper Jams at the Duplex Transport Guide**

If the jammed paper cannot be removed easily, do not forcibly pull it out, but follow the procedure for a different paper jam location indicated by the message.

**1 Pull out the paper drawer until it stops, and remove it while lifting the front side.**

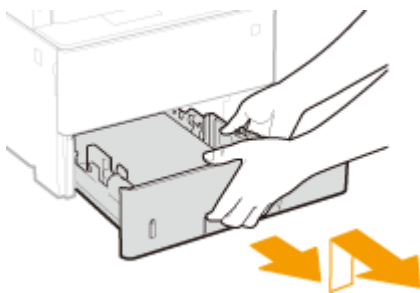

**2 Press the green knob and lower the duplex transport guide.**

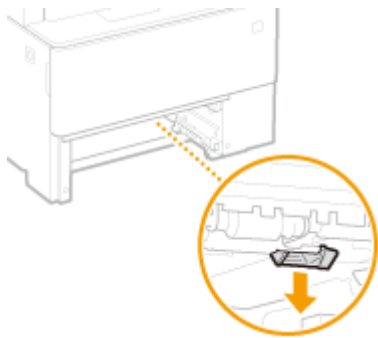

**3 Gently pull out the paper.**

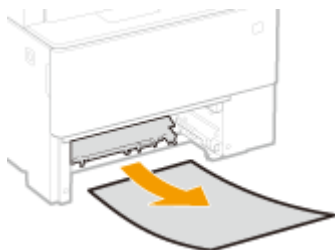

**4 Return the duplex transport guide back to position.**

- Fully close the guide until it clicks.

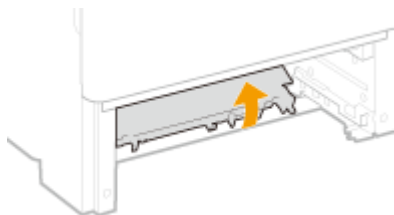

**5 Set the paper drawer.**

**6 Open and close the front cover.**

- When the front cover is opened and closed, the paper jam message disappears.

**1 Open the front cover.**

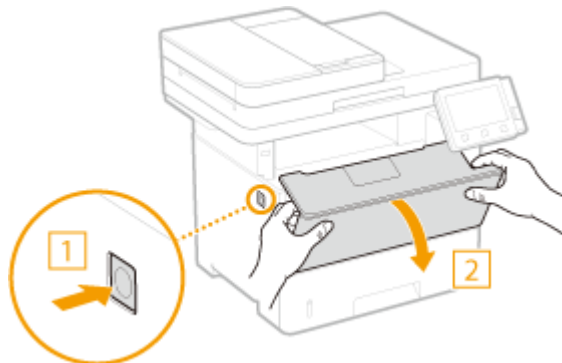

**2 Close the front cover.**

**NOTE:**

**When the message is still displayed**

- Paper may be jammed in other locations. Check other locations, and remove jammed paper if any. If the message is still displayed, check whether the front cover is securely closed.

## Paper Jams in a Paper Source

Remove the jammed paper according to the procedure that matches the location at which a paper jam occurred.

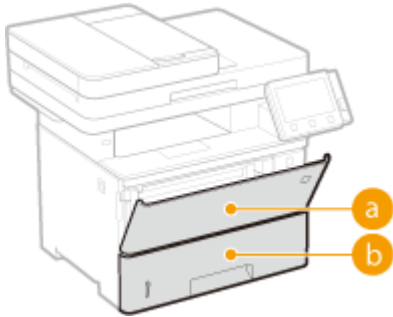

### a Multi-purpose tray

▶ Paper Jams in the Multi-Purpose Tray(P. 652)

### b Paper drawer

▶ Paper Jams in the Paper Drawer(P. 652)

### Paper Jams in the Multi-Purpose Tray

If there is paper loaded in the tray, remove it first. If the jammed paper cannot be removed easily, do not forcibly pull it out, but follow the procedure for a different paper jam location indicated by the message.

#### 1 Gently pull out the paper.

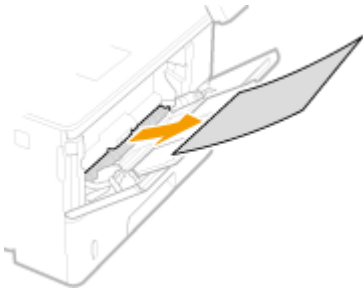

#### 2 Load paper. ▶ Loading Paper in the Multi-Purpose Tray(P. 145)

#### 3 Select <Yes> when the <Is all of the jammed paper removed?> message is displayed on the screen.

#### NOTE:

When the message is still displayed

- Paper may be jammed in other locations. Check other locations, and remove jammed paper if any.

### Paper Jams in the Paper Drawer

If the jammed paper cannot be removed easily, do not forcibly pull it out, but follow the procedure for a different paper jam location indicated by the message.

#### 1 Pull out the paper drawer until it stops.

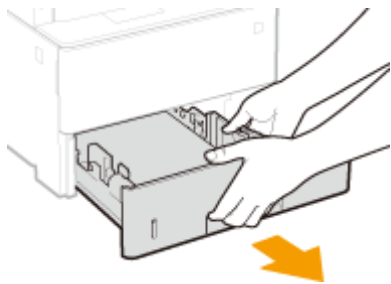

**2 Gently pull out the paper.**

- When the optional paper feeder is attached, gently pull out the paper in the same way.

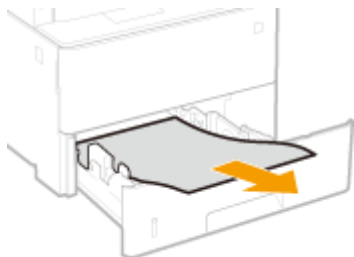

**3 Set the paper drawer.**

**4 Select <Yes> when the <Is all of the jammed paper removed?> message is displayed on the screen.**

**NOTE:**

**When the message is still displayed**

- Paper may be jammed in other locations. Check other locations, and remove jammed paper if any.

## When a Problem Cannot Be Solved

261J-0AS

If you cannot solve a problem by referring to the information in this chapter, contact your local authorized Canon dealer or the Canon help line.

### IMPORTANT

#### Do not disassemble or repair the machine yourself

- If you disassemble or repair the machine yourself, it may not be covered by warranty.

#### ■ When Contacting Canon

When contacting us, have the following information ready:

- Product name (MF525x / MF522x)
- Dealer where you purchased the machine
- Details about your problem (such as what you did and what happened as a result)
- Serial number (found on the label on the back side of the machine)

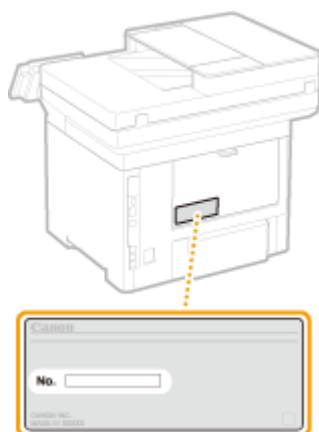

### NOTE

#### Checking the serial number from the operation panel

- Select <Status Monitor> ► <Device Information> ► <Serial Number>.

# Appendix

<b>Appendix</b> .....	656
<b>Third Party Software</b> .....	658
<b>Feature Highlights</b> .....	659
Going Green and Saving Money .....	660
Improving Efficiency .....	662
Going Digital .....	664
So Much More .....	666
<b>Specifications</b> .....	668
Main Unit .....	669
Feeder .....	672
Available Paper .....	673
Paper Feeder PF-C .....	676
Copy Card Reader-F .....	677
Fax Function .....	678
Scan Function .....	679
Printer Functions .....	680
Management Functions .....	682
System Environment .....	684
Network Environment .....	686
<b>Options</b> .....	687
Optional Equipment .....	688
System Options .....	690
<b>Manuals and Their Contents</b> .....	692
<b>Using User's Guide</b> .....	693
Screen Layout of User's Guide .....	694
Viewing User's Guide .....	697
<b>Basic Windows Operations</b> .....	698
<b>Notice</b> .....	706

# Appendix

---

261J-0AU

This chapter contains technical specifications of this machine, instructions on how to use the User's Guide, disclaimers, copyright information, and other important information for customers.

## ■ Machine Specifications

See the following section(s) when you want to check the specifications of the main unit and optional equipment, network environment, print function, and so on.



▶ Specifications(P. 668)

## ■ Using Optional Equipment

See the following section(s) when you want to check what options are available to use this machine more conveniently and more effectively.

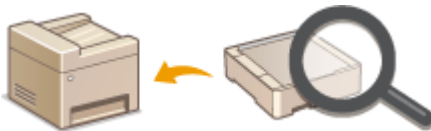

▶ Options(P. 687)

## ■ Referencing the Manual of This Machine

See the first of the following sections when you want to be sure of the kinds of the manuals describing the functions of the machine and how to operate the machine. When you want to know how to read and use the User's Guide (this manual), see the second section.



▶ Manuals and Their Contents(P. 692)

▶ Using User's Guide(P. 693)

## ■ Others

See the following section(s) when you want to get useful information, and check the disclaimers and copyright information.





- ▶ **Third Party Software(P. 658)**
- ▶ **Feature Highlights(P. 659)**
- ▶ **Basic Windows Operations(P. 698)**
- ▶ **Notice(P. 706)**

## Third Party Software

---

261J-0AW

For information related to third-party software, click the following icon(s).



## Feature Highlights

---

261J-0AX

This section describes tips for leveraging the features of the machine by category. You can make use of the features according to your intended purposes and operating environment.

- ▶ **Going Green and Saving Money(P. 660)**
- ▶ **Improving Efficiency(P. 662)**
- ▶ **Going Digital(P. 664)**
- ▶ **So Much More(P. 666)**

## Going Green and Saving Money



There are lots of ways to cut back on paper, toner, power, and expenses.



### 2-Sided Printing

You can use 2-sided printing for copies, print jobs sent from your computer, and even incoming faxes. Because you'll only be using half the paper you would otherwise, you can cut your paper costs in half. To save even more, combine 2-sided printing with N on 1 printing of multiple pages on one sheet of paper. You can print up to 32 pages on a single sheet, which is both economical and environmentally friendly.

▶ **Basic Copy Operations(P. 191)**

▶ **Printing from a Computer(P. 254)**

▶ **<Receive/Forward>(P. 529)** ▶ <Fax Settings> ▶ <Print on Both Sides>

▶ **<Receive/Forward>(P. 529)** ▶ <I-Fax Settings> ▶ <Print on Both Sides>



### Print Multiple Pages on a Single Sheet

To really start saving paper, shrink multiple pages onto one side of a sheet - 2 or 4 pages for copies, and up to 16 pages for print jobs sent from your computer. This is even more effective when used together with 2-sided printing.

▶ **Copying Multiple Documents onto One Sheet (N on 1)(P. 204)**

▶ **Printing from a Computer(P. 254)**



### Sleep Mode



### Paperless Faxing

For saving energy and money, a sleep mode that powers down a machine when nobody is using it has become an essential feature. This machine will enter sleep mode automatically, and can also be put to sleep whenever you want. Press  once to put the machine to sleep. Press it again to instantly wake the machine back into action.

▶ **Entering Sleep Mode(P. 174)**

Assume you need paper to fax? Those old paper printouts you always make are a thing of the past. Send documents by fax just as they are, created on your computer. It's paperless, so it's fast. And, received documents are first stored in memory, allowing you to print out only those needed and eliminating worry about paper getting used on direct mailings, etc.

▶ **Sending Faxes from Your Computer (PC Fax)(P. 240)**

▶ **Saving Received Documents into the Machine (Memory Reception)(P. 234)**

## Improving Efficiency

261J-OC0



Here are some simple operations that can make complicated tasks more efficient.

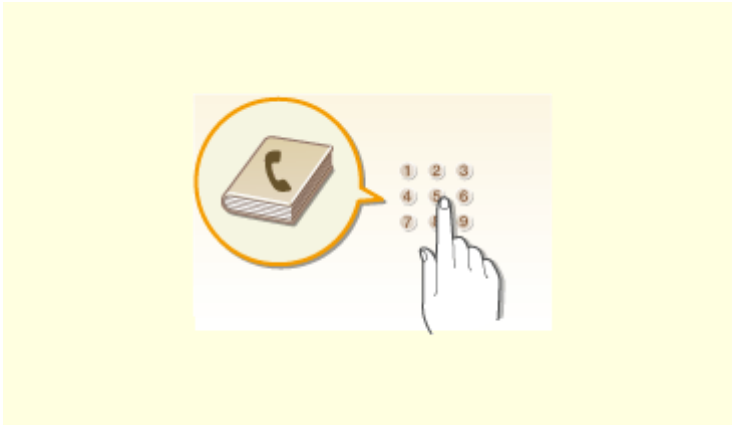

### Address Book

Entering fax and e-mail addresses in the Address Book saves you the inconvenience of entering them number-by-number, letter-by-letter every time you have something to send. Display the addresses you use most frequently with the <Favorites> feature to quickly and easily send what you need to the people who need it. You can save your Address Book data on your computer and feel secure knowing that your important contact information is backed up.

- ▶ **Registering Destinations(P. 176)**
- ▶ **Registering Destinations from Remote UI(P. 427)**
- ▶ **Basic Operations for Sending Faxes(P. 214)**
- ▶ **Basic Operations for Scanning Originals(P. 279)**
- ▶ **Importing/Exporting the Setting Data(P. 437)**

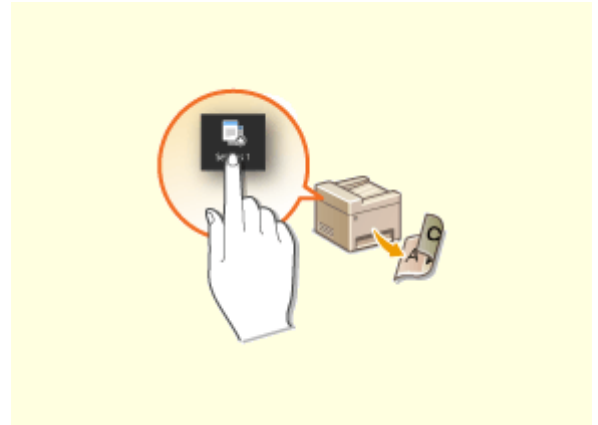

### Frequently Used Settings in One Touch

Always making 2-sided copies. Always scanning in the same format and to the same save destination. Frequently used settings like these can be registered to a single shortcut button. This is convenient by allowing you to specify involved operations all in a single touch.

- ▶ **Registering Frequently Used Settings(P. 168)**



### Print Images Right Off Your USB Memory Device



### Remote Management with Remote UI

Plug a USB memory device into the machine and you can print images and documents directly, without using a computer. You can even preview JPEG and other images before you print, so there is no wasted paper. You can also scan handwritten memos, etc. and save them directly to a USB memory device. Convenient for carrying about.

▶ **Printing from a USB Memory Device (Memory Media Print)(P. 265)**

▶ **Basic Operations for Scanning Originals(P. 279)**

Remote UI lets you manage a lot from your computer, all without having to go over to the machine. Configure settings and keep an eye on the machine's status with an intuitive, easy-to-understand Web browser interface that you'll master immediately. Save your time and energy for things other than taking care of the machine.

▶ **Managing the Machine from a Computer (Remote UI)(P. 414)**

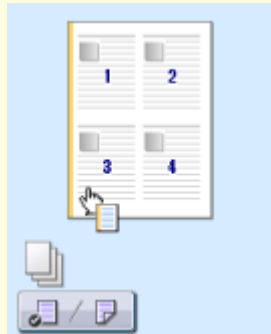

### **Make Print Settings Quickly with Intuitive Operation**

You can easily specify the page layout as well as binding position, switching between 1-sided and 2-sided printing, etc. intuitively on the preview image in the printer driver. The simple click-operation allows you to conveniently make settings while viewing how settings are applied.

▶ **Printing from a Computer(P. 254)**

## Going Digital

261J-OC1



Digitalizing a document enables editing using a computer as well as reducing cost and time by using e-mail.



### Scan and E-Mail

E-mail scanned originals without even turning on your computer. Just convert your scanned original into an e-mail attachment right from the machine. If you're one of those people who'd rather send a fax than mess around with a computer, this feature is for you.

▶ **Basic Operations for Scanning Originals(P. 279)**



### Scan and Share

Say you've got a paper copy of a report for a company-wide meeting. Scan it, convert it, and now everyone can see it. It's saved directly in a shared folder on your network, so there's no need to print out copies and pass them out. Once you start talking about hundreds of pages of documents that everyone needs, there's just no other way to go.

▶ **Basic Operations for Scanning Originals(P. 279)**



### Scan Only What You Need



### Searchable PDFs



What if you're scanning a whole page of a newspaper but all you're really interested in is a headline and a photo? Use ScanGear MF. You can select what you want from a preview, and then have the scanner disregard the rest. Otherwise you'll have to use an editing program to crop out everything you don't need.

▶ **Using ScanGear MF(P. 317)**

## IMPORTANT

- Using your product to scan, print or otherwise reproduce certain documents, and the use of such images as scanned, printed or otherwise reproduced by your product, may be prohibited by law and may result in criminal and/or civil liability. If you are uncertain about the legality of using your product to scan, print or otherwise reproduce any particular document, and/or of the use of the images scanned, printed or otherwise reproduced, you should consult in advance with your legal advisor for guidance.

Searching of text in a PDF can be done with a "searchable PDF." By scanning an original with both text and images, text portions are converted by OCR into text data. In addition to being able to search for text information, you can also copy required portions into an Excel spreadsheet or Word document in Microsoft Office. Eliminate the need to type in customer data, addresses, etc. from scratch.

▶ **Basic Operations for Scanning Originals(P. 279)**

▶ **Using Your Computer to Scan (Remote Scan) (P. 314)**



### Add Images to a Work in Progress

Some applications work with the machine to let you easily import scanned images directly into documents you're working on. This way you can skip the steps of opening a separate application just for receiving the scanned images and then exporting them to the application you're really using.

▶ **Scanning Documents from an Application(P. 315)**

## So Much More

261J-0C2



There are a variety of features for whatever you need to do - at home, in the office, or even on the road.



### Application Library to execute useful functions in one-touch button operation

Application Library is a facility that makes it possible that frequently used operations such as printing a usual document and checking the consumables information as well as convenient functions are registered in the form of applications. You can execute these applications in one-touch button operation from the Home screen. Make the best use of Application Library for time reduction and operational accuracy enhancement. For more information, see the manual on Application Library on the online manual website.



### Using a smartphone/tablet

At times such as when you want to quickly print out a proposal you completed on a tablet while travelling to a business destination, or scan materials handed out at a meeting using a smartphone, Canon PRINT Business comes in handy. Even in environments without a wireless LAN router, you can connect to the machine with a mobile device wirelessly and directly. PCless, quick, and easy! An even broader range of possibilities for work/play with functionality made for this age of speed.

▶ **Linking with Mobile Devices(P. 319)**



### Easy Printing with Google Cloud Print



### Keep Your Printouts Private

Hook up to Google Cloud Print with your laptop or cell phone, send your data, and out come your printed documents. With this machine, Google Cloud Print, and your mobile device, print whenever you want from wherever you want.

▶ **Using Google Cloud Print(P. 341)**

Normally, when you print something from your computer, it comes out of the printer right away. However, if you have sensitive documents, this may not be what you want. Just use secure printing and no one will be able to print your documents without entering your password on the machine's operation panel. Don't let your confidential documents lie exposed on the tray for everyone to see.

▶ **Printing a Document Secured by a PIN (Secure Print) (P. 261)**



**Go Wireless**

No cables, easy installation, simple maintenance. If you've got a WPS wireless LAN router, bypass the settings process altogether and be ready to go before you know it. Enjoy the kind of clutter-free and easy to use document system that you can only get from wireless. Compatible with IEEE 802.11b/g/n for stress-free wireless, and also supports WEP and WPA/WPA2-PSK (TKIP/AES-CCMP) for tighter security.

▶ **Connecting to a Wireless LAN(P. 18)**



**Get Faxes Wherever You Go**

Never worry about missing a fax when you're out of the office. Set a forwarding destination and any fax that comes in on the machine will go right to you. Better yet, make the forwarding destination the e-mail address for your tablet or mobile.

▶ **Forwarding the Received Documents Automatically(P. 236)**

# Specifications

---

261J-0C3

Specifications are subject to change without notice for product improvement or future release.

## ■ Machine Specifications

- ▶ Main Unit(P. 669)
- ▶ Feeder(P. 672)
- ▶ Available Paper(P. 673)

## ■ Specifications of Optional Equipment

- ▶ Paper Feeder PF-C(P. 676)
- ▶ Copy Card Reader-F(P. 677)

## ■ Functional Specifications

- ▶ Fax Function(P. 678)
- ▶ Scan Function(P. 679)
- ▶ Printer Functions(P. 680)
- ▶ Management Functions(P. 682)

## ■ Environment To Use the Machine

- ▶ System Environment(P. 684)
- ▶ Network Environment(P. 686)

# Main Unit

261J-0C4

## NOTE

- For information on paper sizes and types for each paper source, see "▶ Available Paper(P. 673) ."

Type	Desktop
Color Supported	Black and White
Resolution for Reading	600 dpi x 600 dpi
Resolution for Writing	600 dpi x 600 dpi
Number of Tones	256
Acceptable Originals	Up to 215.9 mm x 355.6 mm Maximum thickness of original: 20 mm
Copy Size/Copy Paper	<p><b>Paper Sizes</b></p> <ul style="list-style-type: none"> <li>Max: 215.9 mm x 355.6 mm</li> <li>Min (Paper Drawer): 105 mm x 148 mm</li> <li>Min (Multi-Purpose Tray): 76.2 mm x 127 mm</li> </ul> <p><b>Margin</b></p> <p><b>Top:</b></p> <ul style="list-style-type: none"> <li>When copying via the platen glass 5 mm ± 2.0 mm</li> <li>When copying via the feeder 5 mm ± 3.0 mm</li> </ul> <p><b>Left or Right:</b></p> <ul style="list-style-type: none"> <li>When copying via the platen glass 5 mm ± 2.0 mm</li> <li>When copying via the feeder 5 mm ± 3.0 mm</li> </ul> <p><b>Paper Weight</b></p> <ul style="list-style-type: none"> <li>Paper Drawer: 52 g/m<sup>2</sup> to 120 g/m<sup>2</sup></li> <li>Multi-Purpose Tray: 52 g/m<sup>2</sup> to 199 g/m<sup>2</sup></li> </ul>
Paper Type	▶ Available Paper(P. 673)
Warm-Up Time <sup>*1</sup>	<p><b>After Powering ON</b></p> <p>14.0 seconds or less</p> <p><b>Returning from the Sleep mode</b></p>

Appendix

	4.0 seconds or less
<b>First Copy Time</b> (A4)	Approx. 6.3 seconds
<b>Copy Speed</b> *2 (A4)	43.0 sheets/minute
<b>Magnification</b>	25 % to 400 % (in 1 % increments)
<b>Paper Feeding System/Capacity</b> *3	<b>Paper Drawer</b> 550 sheets (80 g/m <sup>2</sup> )/640 sheets (64 g/m <sup>2</sup> ) x 1 <b>Multi-Purpose Tray</b> 100 sheets (80 g/m <sup>2</sup> )/100 sheets (64 g/m <sup>2</sup> ) x 1
<b>Paper Output System/Capacity</b> *3	<b>Output Tray</b> 250 sheets (68 g/m <sup>2</sup> )
<b>Multiple Copies</b>	999 sheets
<b>Power Source</b>	AC 220 V - 240 V, 3.9 A, 50 Hz/60 Hz
<b>Power Consumption</b> *1	<b>Maximum Power Consumption</b> 1,380 W or less <b>During Sleep Mode</b> <ul style="list-style-type: none"> <li>● Approx. 0.9 W (USB connection)</li> <li>● Approx. 0.9 W (wired LAN connection)</li> <li>● Approx. 0.9 W (wireless LAN connection)</li> </ul> <b>With the Main Power Turned OFF</b> 0.1 W or less
<b>Dimensions</b> (W x D x H)	<b>MF525x:</b> 494 mm x 464 mm x 452 mm <b>MF522x:</b> 480 mm x 464 mm x 452 mm
<b>Weight</b>	<b>Main Unit</b> *4 Approx. 19.0 kg <b>Consumables</b> ▶ <b>Consumables(P. 586)</b>
<b>Installation Space</b>	See "Getting Started" ▶ <b>Manuals and Their Contents(P. 692)</b>

## Appendix

<b>Memory Capacity</b>	<b>RAM:</b> 1 GB
<b>Environmental Conditions</b>	Temperature: 10°C to 30°C Humidity: 20 % to 80 % RH (no condensation)

\*1May vary depending on the environment and conditions under which the machine is being used.

\*2Copy/print speeds are measured based on internal testing using A4 size paper copied/printed with 100% copy/print ratio to original on one-sided paper. Internal testing involved continuously copying/printing the same one page of content on plain paper (copy speed is tested by copying on the platen glass). Copy/print speeds may vary depending on paper type, paper size or paper feeding direction.  
The device may automatically pause or slow down in order to adjust printer condition such as controlling temperature of a certain unit or limiting impact to image quality during continuous copying/printing.

\*3May vary depending on the installation environment and paper to use.

\*4The toner cartridge is not included.

# Feeder

261J-OC5

<b>Original Feeding Mechanism</b>	Automatic 2-Sided Document Feeder
<b>Original Size <sup>*1</sup> /Type</b>	<p><b>Size of Originals</b></p> <ul style="list-style-type: none"> <li>• <b>Max</b> : 215.9 mm x 355.6 mm</li> <li>• <b>Min</b> : 105 mm x 128 mm</li> </ul> <p><b>Weight of Originals</b></p> <p>50 g/m<sup>2</sup> to 105 g/m<sup>2</sup></p>
<b>Original Tray Capacity</b> (A4)	50 sheets (80 g/m <sup>2</sup> )
<b>Original Scanning Speed</b>	<p><b>Copying (300 dpi x 600 dpi, A4)</b></p> <p><b>1-Sided Scanning:</b></p> <ul style="list-style-type: none"> <li>• 40 pages/minute</li> </ul> <p><b>2-Sided Scanning:</b></p> <ul style="list-style-type: none"> <li>• 67 pages/minute</li> </ul> <p><b>Scanning (300 dpi x 300 dpi, A4) <sup>*2</sup></b></p> <p><b>1-Sided Scanning:</b></p> <ul style="list-style-type: none"> <li>• <b>Full Color (PDF):</b> 13.4 pages/minute</li> <li>• <b>Black and White (TIFF):</b> 38.1 pages/minute</li> </ul> <p><b>2-Sided Scanning:</b></p> <ul style="list-style-type: none"> <li>• <b>Full Color (PDF):</b> 26.9 pages/minute</li> <li>• <b>Black and White (TIFF):</b> 70.5 pages/minute</li> </ul>

<sup>\*1</sup>To maintain the optimum image quality, it is recommended to scan A6 size original(s) from the platen glass.

<sup>\*2</sup>May vary depending on the environment and conditions under which the machine is being used.



## Available Paper

261J-0C6

The paper types that can be used with this machine are shown in the following table.

### ■ Supported Paper Sizes

✓ : Available — : Unavailable

Paper Sizes	Paper Drawer <sup>*1</sup>	Multi-Purpose Tray	Automatic 2-Sided Printing <sup>*2</sup>
A4 <sup>*3*4*5</sup>	✓	✓	✓
B5 <sup>*3</sup>	✓	✓	—
A5 <sup>*3*6</sup>	✓	✓	—
A6	✓	✓	—
Legal (LGL) <sup>*3*4</sup>	✓	✓	✓
Letter (LTR) <sup>*3*4*5</sup>	✓	✓	✓
Statement (STMT) <sup>*3</sup>	✓	✓	—
Executive (EXEC)	✓	✓	—
Oficio <sup>*3*4</sup>	✓	✓	✓
Oficio (Brazil) <sup>*3*4</sup>	✓	✓	✓
Oficio (Mexico) <sup>*3*4</sup>	✓	✓	✓
Letter (Government) <sup>*3*4</sup>	✓	✓	—
Legal (Government) <sup>*3*4</sup>	✓	✓	—
Foolscap/Folio <sup>*3*4</sup>	✓	✓	✓
Foolscap (Australia) <sup>*3*4</sup>	✓	✓	—
Legal (India) <sup>*4</sup>	✓	✓	✓
3x5inch	—	✓	—

Paper Sizes	Paper Drawer <sup>*1</sup>	Multi-Purpose Tray	Automatic 2-Sided Printing <sup>*2</sup>
Envelope No.10 (COM10)	—	✓	—
Envelope Monarch	—	✓	—
Envelope C5	—	✓	—
Envelope DL	—	✓	—
Custom Paper Size	✓ <sup>*7</sup>	✓ <sup>*8</sup>	✓ <sup>*9</sup>

<sup>\*1</sup>Includes the optional Paper Feeder PF-C.

<sup>\*2</sup>Automatic 2-sided printing is available without replacing paper.

<sup>\*3</sup>Allows you to print received fax documents.

<sup>\*4</sup>Allows you to print received I-Fax documents.

<sup>\*5</sup>Allows you to print reports or lists.

<sup>\*6</sup>Landscape or portrait orientation is available.

<sup>\*7</sup>The custom size ranging from 105 mm x 148 mm to 215.9 mm x 355.6 mm is available.

<sup>\*8</sup>The custom size ranging from 76.2 mm x 127 mm to 215.9 mm x 355.6 mm is available.

<sup>\*9</sup>The custom size ranging from 210 mm x 279.4 mm to 215.9 mm x 355.6 mm is available.

## ■ Supported Paper Types

Chlorine-free paper can be used with this machine.

✓ : Available    — : Unavailable

Paper Type		Paper Drawer <sup>*1</sup>	Multi-Purpose Tray	Automatic 2-Sided Printing <sup>*2</sup>
Plain 1 <sup>*3*4</sup>	60 g/m <sup>2</sup> to 74 g/m <sup>2</sup>	✓	✓	✓
Plain 2 <sup>*3*4</sup>	75 g/m <sup>2</sup> to 89 g/m <sup>2</sup>	✓	✓	✓
Recycled 1 <sup>*3*4</sup>	60 g/m <sup>2</sup> to 74 g/m <sup>2</sup>	✓	✓	✓
Recycled 2 <sup>*3*4</sup>	75 g/m <sup>2</sup> to 89 g/m <sup>2</sup>	✓	✓	✓
Color <sup>*3*4</sup>	60 g/m <sup>2</sup> to 74 g/m <sup>2</sup>	✓	✓	✓
Heavy 1	90 g/m <sup>2</sup> to 105 g/m <sup>2</sup>	✓	✓	✓
Heavy 2	106 g/m <sup>2</sup> to 120 g/m <sup>2</sup>	✓	✓	✓
Heavy 3	121 g/m <sup>2</sup> to 149 g/m <sup>2</sup>	—	✓	—

Appendix

Paper Type		Paper Drawer <sup>*1</sup>	Multi-Purpose Tray	Automatic 2-Sided Printing <sup>*2</sup>
<b>Heavy 4</b>	150 g/m <sup>2</sup> to 199 g/m <sup>2</sup>	—	✓	—
<b>Thin 1</b> <sup>*3*5</sup>	60 g/m <sup>2</sup>	✓	✓	✓
<b>Thin 2</b>	52 g/m <sup>2</sup> to 59 g/m <sup>2</sup>	✓	✓	—
<b>Bond 1</b>	60 g/m <sup>2</sup> to 74 g/m <sup>2</sup>	✓	✓	✓
<b>Bond 2</b>	75 g/m <sup>2</sup> to 104 g/m <sup>2</sup>	✓	✓	✓
<b>Bond 3</b>	105 g/m <sup>2</sup> to 120 g/m <sup>2</sup>	✓	✓	✓
<b>Labels</b>		—	✓	—
<b>Envelope</b>		—	✓	—
<b>Envelope H</b>		—	✓	—

<sup>\*1</sup>Includes the optional Paper Feeder PF-C.

<sup>\*2</sup>Automatic 2-sided printing is available without replacing paper.

<sup>\*3</sup>Allows you to print received fax/I-Fax documents.

<sup>\*4</sup>Allows you to print reports or lists.

<sup>\*5</sup>Select this if paper curl occurs when the paper type setting <Plain 1> is specified for paper of 60 g/m<sup>2</sup>.

## Paper Feeder PF-C

---

261J-0C7

<b>Paper Sizes</b>	<ul style="list-style-type: none"> <li>● Max: 215.9 mm x 355.6 mm</li> <li>● Min: 105 mm x 148 mm</li> </ul>
<b>Paper Weight</b>	52 g/m <sup>2</sup> to 120 g/m <sup>2</sup>
<b>Paper Drawers Capacity *</b>	550 sheets (80 g/m <sup>2</sup> )/640 sheets (64 g/m <sup>2</sup> ) x 1
<b>Dimensions</b> (W x D x H)	417 mm x 373 mm x 156 mm
<b>Weight</b>	Approx. 4.0 kg

\*May vary depending on the installation environment and paper to use.

## Copy Card Reader-F

---

261J-0C8

<b>Available Cards</b>	Magnetic
Card Readout Method	Magnetic readout
<b>Magnetic Card Reading Direction</b>	Face up
<b>Store/Replay</b>	Replay
<b>Dimensions</b> (W x D x H)	88 mm x 96 mm x 40 mm (excluding the attachment kit and cable)
<b>Weight</b>	Approx. 200 g (including the attachment kit and cable)

# Fax Function

261J-0C9

<b>Telephone Line Used</b> *1	Public Switched Telephone Network, Facsimile Communication Network (PSTN)
<b>Scan Line Density</b>	<p><b>Normal</b></p> <p><b>G3:</b> 8 pels<sup>*2</sup>/mm x 3.85 line/mm</p> <p><b>Fine</b></p> <p><b>G3:</b> 8 pels<sup>*2</sup>/mm x 7.7 line/mm</p> <p><b>Superfine</b></p> <p><b>G3:</b> 8 pels<sup>*2</sup>/mm x 15.4 line/mm</p> <p><b>Ultrafine</b></p> <p><b>G3:</b> 16 pels<sup>*2</sup>/mm x 15.4 line/mm</p>
<b>Transmission Speed</b> *3	<p><b>Super G3:</b> 33.6 kbps</p> <p><b>G3:</b> 14.4 kbps</p>
<b>Compression Method</b>	MH, MR, MMR, JBIG
<b>Transmission Type</b>	Super G3, G3
<b>Max. Sending Original Sizes</b>	A4
<b>Receiving Paper Sizes</b>	▶ <b>Available Paper(P. 673)</b>
<b>Transmission Times</b>	Approx. 2.6 seconds/page <sup>*4</sup>

\*1 Depending on your locale or your telephone connection, you may be unable to perform data communication. In this case, contact your local authorized Canon dealer or the Canon help line.

\*2 Pels stands for picture elements (pixels).

\*3 With the Automatic Fallback function.

\*4 Value obtained with Canon original test sheet of A4 size, standard ECM (JBIG) transmission.

## Scan Function

---

261J-0CA

<b>Type</b>	Color Scanner
<b>Original Scanning Size (Max)</b>	215.9 mm x 355.6 mm
<b>Resolution (Max)</b>	600 dpi x 600 dpi
<b>Scanning Speed</b>	Same as "Original Scanning Speed" in "Feeder" ▶ <b>Feeder(P. 672)</b>
<b>Interface</b>	<b>USB</b> USB 2.0 Hi-Speed <b>Wired LAN</b> 10Base-T, 100Base-TX, 1000Base-T (IEEE 802.3 compliant) <b>Wireless LAN</b> IEEE 802.11b, IEEE 802.11g, IEEE 802.11n
Protocol Supported *	FTP (TCP/IP), SMB (TCP/IP), SMTP, TCP/IP, USB
<b>Output Format *</b>	TIFF (MMR), JPEG (Single-Page), PDF

\*Some formats are not supported depending on the function.

## Printer Functions

261J-0CC

### ■ UFR II Printer Function

Type	Internal
Print Size	▶ <b>Available Paper(P. 673)</b>
Print Speed	Same as "Copy Speed" in "Main Unit" ▶ <b>Main Unit(P. 669)</b>
Resolution	<b>Data Processing</b> 1200 dpi x 1200 dpi, 600 dpi x 600 dpi
Page Description Language (PDL)	UFR II
Protocol Supported	<b>TCP/IP:</b> LPD, Port9100, IPP, IPPS, WSD
Resident Fonts	None
Interface	<b>USB</b> USB 2.0 Hi-Speed <b>Wired LAN</b> 10Base-T, 100Base-TX, 1000Base-T (IEEE 802.3 compliant) <b>Wireless LAN</b> IEEE 802.11b, IEEE 802.11g, IEEE 802.11n

### ■ PS Printer Function

Type	Internal
Print Size	▶ <b>Available Paper(P. 673)</b>
Print Speed	Same as "Copy Speed" in "Main Unit" ▶ <b>Main Unit(P. 669)</b>
Resolution	<b>Data Processing</b> 1200 dpi x 1200 dpi, 600 dpi x 600 dpi
Page Description Language (PDL)	Adobe PS 3



Protocol Supported	<b>TCP/IP:</b> LPD, Port9100, IPP, IPPS, WSD
Resident Fonts	136 Roman
Interface	<p><b>USB</b></p> <p>USB 2.0 Hi-Speed</p> <p><b>Wired LAN</b></p> <p>10Base-T, 100Base-TX, 1000Base-T (IEEE 802.3 compliant)</p> <p><b>Wireless LAN</b></p> <p>IEEE 802.11b, IEEE 802.11g, IEEE 802.11n</p>

### ■ PCL Printer Function

Type	Internal
Print Size	▶ <b>Available Paper(P. 673)</b>
Print Speed	Same as "Copy Speed" in "Main Unit" ▶ <b>Main Unit(P. 669)</b>
Resolution	<b>Data Processing</b> 1200 dpi x 1200 dpi (only for PCL6), 600 dpi x 600 dpi
Page Description Language (PDL)	PCL6, PCL5
Protocol Supported	<b>TCP/IP:</b> LPD, Port9100, IPP, IPPS, WSD
Resident Fonts	93 Roman
Interface	<p><b>USB</b></p> <p>USB 2.0 Hi-Speed</p> <p><b>Wired LAN</b></p> <p>10Base-T, 100Base-TX, 1000Base-T (IEEE 802.3 compliant)</p> <p><b>Wireless LAN</b></p> <p>IEEE 802.11b, IEEE 802.11g, IEEE 802.11n</p>

### ■ Memory Media Print Function

Printable File Formats	<ul style="list-style-type: none"> <li>● JPEG (DCF/Exif 2.21 or earlier/JFIF)</li> <li>● TIFF (JPEG/MH/MR/MMR compression)</li> <li>● PDF</li> </ul>
------------------------	--

# Management Functions

261J-OCE

## ■ Authentication Functions

- The machine communicates with LDAP servers using LDAPv3.
- UTF-8 is the supported character encoding used when the text data is transmitted between the machine and an LDAP server.

## ■ Firewall Settings

- Up to 16 IP addresses (or ranges of IP addresses) can be specified for both IPv4 and IPv6.
- The packet filters described in this section control communications over TCP, UDP, and ICMP.
- Up to 32 MAC addresses can be specified.

## ■ IPsec

- IPsec that is supported by the machine conforms to RFC2401, RFC2402, RFC2406, and RFC4305.

Operating system	<ul style="list-style-type: none"> <li>• Windows Vista</li> <li>• Windows 7</li> <li>• Windows 8</li> <li>• Windows 8.1</li> <li>• Windows 10</li> </ul>	
Connection mode	Transport mode	
Key exchange protocol	IKEv1 (main mode)	
	Authentication method	<ul style="list-style-type: none"> <li>• Pre-shared key</li> <li>• Digital signature</li> </ul>
	Hash algorithm (and key length)	<ul style="list-style-type: none"> <li>• HMAC-SHA1-96</li> <li>• HMAC-SHA2 (256 bits or 384 bits)</li> </ul>
	Encryption algorithm (and key length)	<ul style="list-style-type: none"> <li>• 3DES-CBC</li> <li>• AES-CBC (128 bits, 192 bits, or 256 bits)</li> </ul>
	Key exchange algorithm/group (and key length)	Diffie-Hellman (DH) <ul style="list-style-type: none"> <li>• Group 1 (768 bits)</li> <li>• Group 2 (1024 bits)</li> <li>• Group 14 (2048 bits)</li> </ul>
ESP	Hash algorithm	HMAC-SHA1-96
	Encryption algorithm (and key length)	<ul style="list-style-type: none"> <li>• 3DES-CBC</li> <li>• AES-CBC (128 bits, 192 bits, or 256 bits)</li> </ul>
	Hash algorithm/encryption algorithm (and key length)	AES-GCM (128 bits, 192 bits, or 256 bits)
AH	Hash algorithm	HMAC-SHA1-96

## NOTE

- IPsec supports communication to a unicast address (or a single device).
- The machine cannot use both IPsec and DHCPv6 at the same time.

### ■ Registration of Keys and Certificates

- If you install a key or CA certificate from a computer, make sure that they meet the following requirements:

Format	<ul style="list-style-type: none"> <li>• Key: PKCS#12<sup>*1</sup></li> <li>• CA certificate: X.509 DER/PEM</li> </ul>
File extension	<ul style="list-style-type: none"> <li>• Key: ".p12" or ".pfx"</li> <li>• CA certificate: ".cer" or ".pem"</li> </ul>
Public key algorithm (and key length)	<ul style="list-style-type: none"> <li>• RSA (512 bits, 1024 bits, 2048 bits, 4096 bits)</li> <li>• DSA (1024 bits, 2048 bits, 3072 bits)</li> <li>• ECDSA (P256, P384, P521)</li> </ul>
Certificate signature algorithm	<ul style="list-style-type: none"> <li>• RSA: SHA-1, SHA-256, SHA-384<sup>*2</sup>, SHA-512<sup>*2</sup>, MD2, MD5</li> <li>• DSA: SHA-1</li> <li>• ECDSA: SHA-1, SHA-256, SHA-384, SHA-512</li> </ul>
Certificate thumbprint algorithm	SHA1

<sup>\*1</sup>Requirements for the certificate contained in a key are pursuant to CA certificates.

<sup>\*2</sup>SHA384-RSA and SHA512-RSA are available only when the RSA key length is 1024 bits or more.

## NOTE

- The machine does not support use of a certificate revocation list (CRL).

### ■ Definition of "Weak Encryption"

When <Prohibit Use of Weak Encrypt.> is set to <On>, the use of the following algorithms is prohibited.

Hash:	MD4, MD5, SHA-1
HMAC:	HMAC-MD5
Common key cryptosystem:	RC2, RC4, DES
Public key cryptosystem:	RSA encryption (512 bits/1024 bits), RSA signature (512 bits/1024 bits), DSA (512 bits/1024 bits), DH (512 bits/1024 bits)

## NOTE

- Even when <Prohibit Weak Encrypt. Key/Cert.> is set to <On>, the hash algorithm SHA-1, which is used for signing a root certificate, can be used.

# System Environment

261J-OCF

<b>System Environment for WSD Scan</b>	<ul style="list-style-type: none"> <li>• Windows 8.1</li> <li>• Windows 10</li> </ul>
<b>System Requirements for the Remote UI</b> *1	<p><b>Windows</b></p> <ul style="list-style-type: none"> <li>• Windows 7 / 8.1 / 10: Internet Explorer 11 or later</li> <li>• Windows 10: Edge</li> </ul> <p><b>macOS</b></p> <ul style="list-style-type: none"> <li>• Mac OS X 10.5 or later</li> <li>• Safari 5.0.6 or later</li> </ul> <p><b>Android</b></p> <ul style="list-style-type: none"> <li>• Chrome</li> <li>• UC Browser</li> </ul> <p><b>iOS</b></p> <ul style="list-style-type: none"> <li>• Safari</li> <li>• UC Browser</li> </ul>
<b>E-mail/I-Fax Forwarding Server Software</b>	<ul style="list-style-type: none"> <li>• Microsoft Exchange Server 2007 SP3</li> <li>• Microsoft Exchange Server 2010</li> <li>• Microsoft Exchange Server 2013</li> <li>• Lotus Domino R7.0</li> <li>• Sendmail 8.14.4</li> </ul>
<b>E-mail/I-Fax Receiving Server Software</b>	<ul style="list-style-type: none"> <li>• Microsoft Exchange Server 2007 SP3</li> <li>• Microsoft Exchange Server 2010</li> <li>• Microsoft Exchange Server 2013</li> <li>• Lotus Domino R7.0</li> <li>• Qpopper 4.0.19</li> </ul>
<b>File Servers Available as Destinations for File Transmission</b>	<p><b>SMB</b></p> <ul style="list-style-type: none"> <li>• Windows Vista SP2 / 7 / 8 / 8.1 / 10</li> <li>• Windows Server 2003 R2 SP2 / Server 2008 / Server 2008 R2 SP1 / Server 2012 / Server 2012 R2</li> <li>• Red Hat Linux 9</li> <li>• OS X 10.9 / 10.10 / 10.11 / 10.12</li> </ul> <p><b>FTP</b></p> <ul style="list-style-type: none"> <li>• Windows Vista SP2 / 7 / Server 2008 SP2 / Server 2008 R2 SP1: Internet Information Services 7.5</li> <li>• Windows 8 / 10 / Server 2012: Internet Information Services 8.0</li> <li>• Windows 8.1 / Server 2012 R2: Internet Information Services 8.5</li> <li>• OS X 10.9 / 10.10 / 10.11 / 10.12</li> <li>• Solaris 10</li> <li>• Red Hat Linux 9</li> </ul>
<b>Types of LDAP servers</b>	<ul style="list-style-type: none"> <li>• Windows Server 2003 R2 SP2 with Active Directory</li> <li>• Windows Server 2008 SP2 with Active Directory</li> </ul>

## Appendix

	<ul style="list-style-type: none"> <li>• Windows Server 2012 with Active Directory</li> <li>• Windows Server 2012 R2 with Active Directory</li> <li>• eDirectory V8.8 SP7 or later</li> <li>• Lotus Domino R8.5 or later</li> </ul>
<b>System Requirements for the Send Function Setting Tool</b>	<ul style="list-style-type: none"> <li>• Windows 7 / 8.1 / 10: Internet Explorer 11 or later</li> <li>• Windows 10: Edge</li> </ul>
<b>System Requirements for the User's Guide</b>	<p><b>Windows</b></p> <ul style="list-style-type: none"> <li>• Internet Explorer 9 or later</li> <li>• Microsoft Edge</li> <li>• Firefox</li> <li>• Firefox ESR</li> <li>• Chrome*<sup>2</sup></li> </ul> <p><b>macOS</b></p> <ul style="list-style-type: none"> <li>• Safari</li> <li>• Firefox</li> <li>• Chrome*<sup>2</sup></li> </ul> <p><b>Linux</b></p> <ul style="list-style-type: none"> <li>• Firefox</li> </ul> <p><b>iOS</b></p> <ul style="list-style-type: none"> <li>• Safari*<sup>2</sup></li> </ul> <p><b>Android</b></p> <ul style="list-style-type: none"> <li>• Chrome*<sup>2</sup></li> </ul>
<b>System Requirements for NFC Function</b>	<ul style="list-style-type: none"> <li>• Android 4.0 or later</li> </ul>

\*<sup>1</sup>Before changing the settings of the machine, set your Web browser to enable all cookies and use JavaScript.

\*<sup>2</sup>Only when viewing manuals on the Internet.

# Network Environment

261J-0CH

## ■ Common Specifications

<b>Protocol Supported</b>	<b>TCP/IP</b> <ul style="list-style-type: none"> <li>● <b>Frame type:</b> Ethernet II</li> <li>● <b>Print applications:</b> LPD, Raw, IPP, IPPS, WSD, Mopria, Google Cloud Print, AirPrint, Windows10 Mobile Print</li> </ul>
---------------------------	---

## ■ Wired LAN Specifications

<b>Interface</b>	Interface supporting 10BASE-T, 100BASE-TX, 1000BASE-T (RJ-45)
------------------	---

## ■ Wireless LAN Specifications

<b>Standard</b>	IEEE 802.11b, IEEE 802.11g, IEEE 802.11n
<b>Transmission Scheme</b>	IEEE 802.11b (Modulation system: DS-SS) IEEE 802.11g (Modulation system: OFDM method) IEEE 802.11n (Modulation system: OFDM method)
<b>Frequency Range</b>	2.412 GHz to 2.472 GHz
<b>Maximum Radio-Frequency Power Transmitted</b>	15.9 dBm
<b>Communication Mode</b>	<ul style="list-style-type: none"> <li>● Infrastructure Mode</li> <li>● Access Point Mode</li> </ul>
<b>Security (encryption method)</b>	<b>Infrastructure Mode</b> <ul style="list-style-type: none"> <li>● 128 (104)/64 (40) bit WEP</li> <li>● WPA-PSK (TKIP/AES-CCMP)</li> <li>● WPA2-PSK (TKIP/AES-CCMP)</li> </ul> <b>Access Point Mode</b> WPA2-PSK (AES-CCMP)
<b>Connection Method</b>	WPS (Wi-Fi Protected Setup), Manual setup

# Options

---

261J-0CJ

Installing options on the machine enables you to use more features.

## ■ Knowing What Types of Options are Available

▶ **Optional Equipment(P. 688)**

▶ **System Options(P. 690)**

## ■ Looking for Optional Equipment by Purpose

### **Adding a Paper Drawer**

---

▶ **Paper Feeder PF-C(P. 688)**

### **Sending Faxes Manually, Making or Receiving Phone Calls**

---

▶ **TELEPHONE 6 KIT(P. 688)**

### **Using the Authentication Function to Manage Users by Department**

---

▶ **Copy Card Reader-F(P. 688)**

## Optional Equipment

261J-0CK

The functionality of the machine can be fully utilized by using the optional equipment described below. Optional equipment can be purchased from the retail outlet where you purchased the machine or from your local Canon dealer.

- ▶ **Paper Feeder PF-C(P. 688)**
- ▶ **TELEPHONE 6 KIT(P. 688)**
- ▶ **Copy Card Reader-F(P. 688)**

### Paper Feeder PF-C

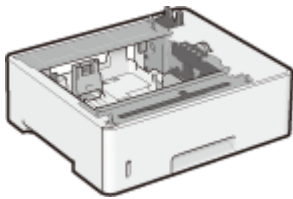

Installing this paper feeder enables you to load paper of a different size than that of paper loaded in the standard paper drawer. This surely reduces the time and labor for paper replacement.

### NOTE

- A maximum of three paper feeders can be installed on the machine.

### TELEPHONE 6 KIT

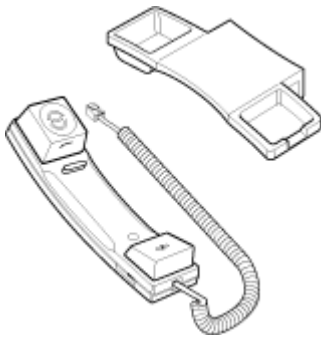

This is a handset that can be connected to the machine. Use the handset when you use the machine as a telephone. Also, use the handset when you send or receive faxes manually.

### Copy Card Reader-F

This is a card authentication system that enables you to perform the login process of Department ID Management by using a control card instead of entering a department ID. You can log in to the machine by inserting a control card and log off by removing it.

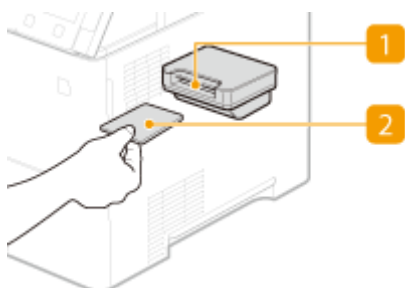



## 1 Card slot

Insert the control card into the card slot when the login screen is displayed. Remove the control card from the card slot after using the machine.



## 2 Control card

You can use the control card shown below. Hold the card the front side up and insert in the direction indicated on the card.



# System Options

261J-0CL

The machine performance can be enhanced even more by installing system options.

- ▶ **Barcode Printing Kit(P. 690)**
- ▶ **Send PDF Security Feature Set(P. 690)**
- ▶ **License Registration(P. 690)**

## Barcode Printing Kit

This option enables you to generate barcodes in various formats. Note that if you want to print barcodes, PCL must be enabled. For information on using the Barcode Printing Kit, see the Barcode Printing Guide (PDF manual).

## Send PDF Security Feature Set

You can enhance the security of PDF files with the Send PDF Security Feature Set. This option enables you to add a digital signature to PDF files or to create encrypted PDF files when scanning originals.

## License Registration

To activate certain system options, you need to obtain a license key and register the key to the machine.

### ■ Obtaining a License Key

You can obtain a license key by using a web browser. Access the License Management System (<http://www.canon.com/lms/license>) and follow the procedure. As a part of the procedure, you are required to enter the following numbers.

#### License Access Number

Check the license access number provided on the License Access Number Certificate that is included in the package of the option.

#### Serial Number of the Machine

Check the serial number of the machine from the operation panel.



<Status Monitor> ▶ <Device Information> ▶ <Serial Number>

### ■ Registering a License Key

**1** Select <Menu> in the Home screen. ▶ **Home Screen(P. 121)**

**2** Select <Management Settings>.

- If the login screen appears, enter the correct ID and PIN. ▶ **Logging in to the Machine(P. 132)**

**3** Select <License/Other> ► <Register License>.

**4** Confirm the message on the screen, and select <OK>.

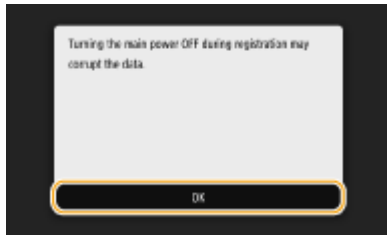

**5** Enter the license key using the numeric keys, and select <Apply>.

► Registration starts. Wait until the <Installation is complete. Changes will be effective after the main power is turned OFF and ON.> message is displayed.

**NOTE:**

- If the <The feature required for installation is not present.> message is displayed, enable the functions that are required to activate the option and register the license key again.





**6** Select <Close>.

**7** Restart the machine.

## Manuals and Their Contents

261J-OCR

The manuals listed below are included with the machine. Refer to them as necessary.

<b>Getting Started</b>		<p>Read this manual first. It describes basic setup procedures, from removing the packing materials to setting up the machine.</p> 
<b>User's Guide (This Manual)</b>		<p>This manual describes all the functions of the machine in a manual that is viewed using a Web browser. You can browse information by category or enter a keyword to search for pages on a specific topic.  <b>Using User's Guide(P. 693)</b></p>
<b>Send Setting Guide</b>		<p>This manual describes how to configure settings and prepare for sending scanned images by e-mail and saving scanned images to shared folders.</p>

## Using User's Guide

261J-OCS

The User's Guide is a manual that can be viewed on your computer or mobile device and it describes all of the functions of the machine. You can search from your intended use or enter a keyword to quickly find the page you are looking for. The section describes the screen layout of the User's Guide and how to read the Guide. You can specify how the appearance of the User's Guide looks.

### ■ Screen Layout of User's Guide

This section describes the screens configuring the User's Guide and how to use the on-screen buttons. [▶Screen Layout of User's Guide\(P. 694\)](#)

### ■ Viewing User's Guide

This section describes the meaning of the marks used in the User's Guide, how the keys on the operation panel and the buttons on the computer display are represented, and other matters that help you understand the information contained in the User's Guide. [▶Viewing User's Guide\(P. 697\)](#)

### ■ Specifying How the Appearance of the User's Guide Looks

You can change the character size used in the User's Guide, and switch the screen layout to fit to the device you use to view the User's Guide.

## NOTE

- If you do not have access to Adobe Reader to view the manuals in PDF format, try other programs such as PDF Preview developed by Vivid Document Imaging Technologies.

### How to Find the Topic You Are Looking for

#### Search the contents

- You can find the page you are looking for by selecting the topic from the "Contents" on the left side of the screen.

#### Search by keyword

- Perform a search by entering a keyword, such as "envelope" or "toner cartridge," and the pages containing the keyword are displayed. You can find the page you are looking for from those results. You can also enter phrases such as "connecting to a network." The keyword search also supports the AND Boolean to search for multiple keywords. For the organization of the search screen and how to operate the search screen, see [▶Search\(P. 696\)](#) .

# Screen Layout of User's Guide

261J-0CU

The User's Guide is divided into different screens, and the content of each screen varies.

## Top Page

Appears when User's Guide is started.

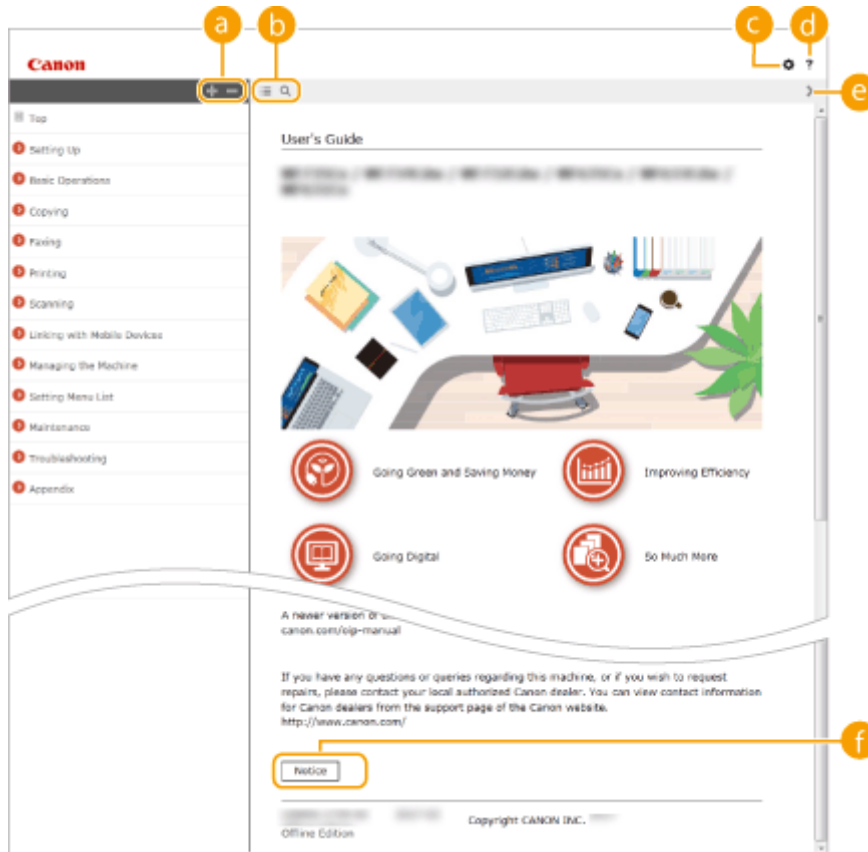

Click to also display all of the sections under the chapters. Click to return to the previous display.



Click to toggle the display between the contents and search. When the table of contents is displayed, each click on switches between hiding and showing the display. When the search display is shown, each click on switches between hiding and showing the display.



Click to set parameters to determine how the User's Guide is displayed, such as character size or layout.



Click to display information on how to view the User's Guide, how to perform a search, and other information.



Click to display the previous or following topic.



Click to view important information you should know when using the machine.

## Topic Page

Contains information about how to configure and use the machine.

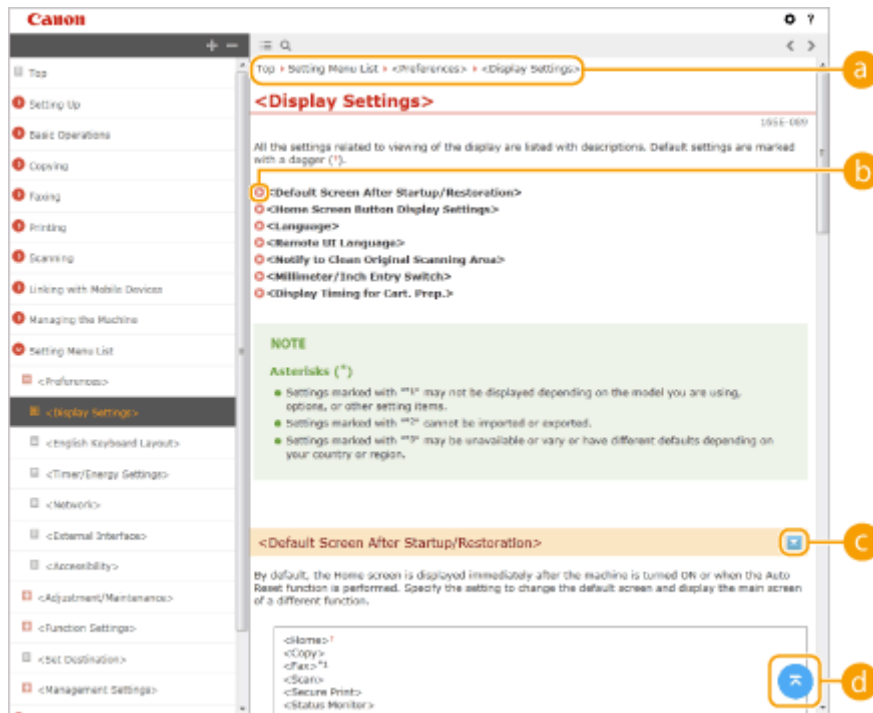

### a Navigation

See what chapter topic you are currently viewing.

### b



Click to jump to the corresponding page. To return to the previous page, click "Back" on your Web browser.

## NOTE:

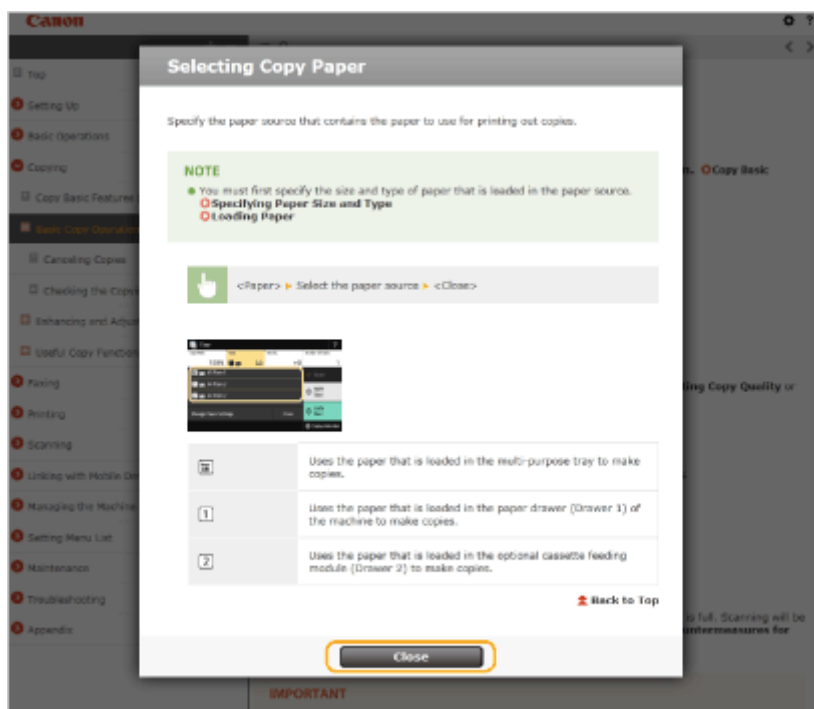
- When you click the icon, the current page may go dark and a pop-up window may appear. To return to the page, click [Close] in the pop-up window.





Click  to display the hidden detailed descriptions. Click  to close the detailed descriptions.



Click to return to the page top.

## Search

Click  to display the search window. Contains a text box to perform a search by keyword and find the page you are looking for.

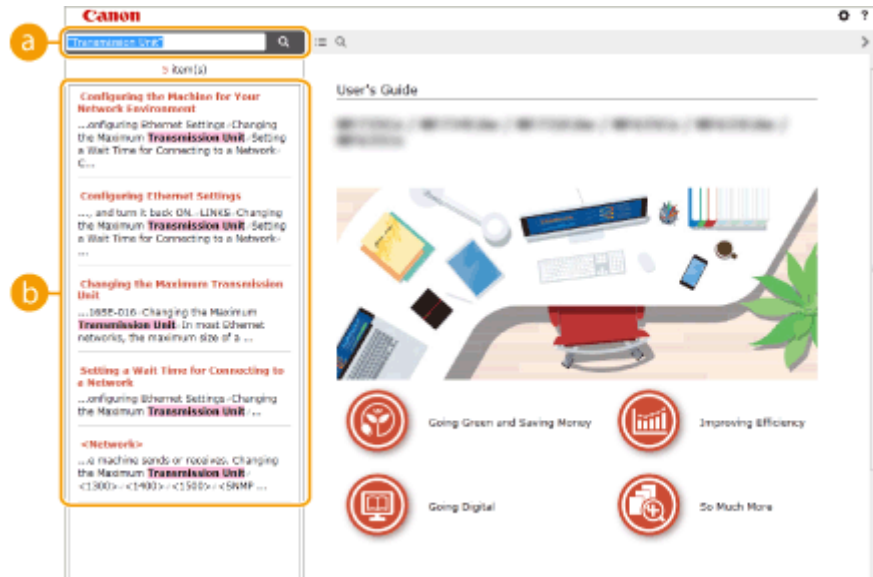

### a [Enter keyword(s) here]

Enter a keyword or keywords and click  to display the search results. You can search for pages containing all the keywords by separating the keywords by a space (blank). Also you can only search for pages containing an exact phrase by enclosing the keywords in double quotation marks.

### b Search result

Displays the search results of the pages that contain the specified keywords. From the results, locate the page you are looking for and click the topic title of the page.

## NOTE:

- The specified keyword(s) are shown in bold in the search results.



# Viewing User's Guide

---

261J-0CW

This section describes the marks, buttons, screens, and other items used in the User's Guide. The warnings and cautions are also given in the "Important Safety Instructions" in the "Getting Started" included with the machine. See also these instructions.

## Marks

---

Cautions regarding safety, restrictions and cautions regarding the handling of the machine, useful tips, and other information are indicated using the marks below.



Indicates an operation that must not be performed. Read these items carefully, and make sure not to perform the described operations.

## IMPORTANT

Indicates operational requirements and restrictions. Be sure to read these items carefully to operate the machine correctly, and avoid damage to the machine or property.

## NOTE

Indicates a clarification of an operation, or contains additional explanations for a procedure.



## TIPS

Indicates useful functions or tips for using the machine.

## Keys and Buttons Used in this Manual

---

Keys on the operation panel and buttons on the computer display appear in the following notation:

Type	Example
Keys on the operation panel	 
Settings displayed on the operation panel	<Timer/Energy Settings> <Paper jammed.>
Buttons and other text interfaces displayed on the computer display	[Preferences]

## Computer Screens Used in This Manual

---

Unless otherwise noted, displays used in the User's Guide are those for the MF525x. Depending on the model or operating system you are using, the appearance of the displays used in this manual may slightly differ from the actual displays. Also, the appearance of drivers and software may differ depending on their version.

## Illustrations Used in This Manual

---

Unless otherwise noted, illustrations used in the User's Guide are those for the MF525x. The illustrations of the toner cartridge are those for the Canon Cartridge 041.

# Basic Windows Operations

261J-0CY

- ▶ **Displaying the Printer Folder**(P. 698)
- ▶ **Enabling [Network discovery]**(P. 698)
- ▶ **Displaying Shared Printers in the Print Server**(P. 699)
- ▶ **Displaying the [Software Programs/Manuals Setup] Screen**(P. 700)
- ▶ **Printing a Test Page in Windows**(P. 700)
- ▶ **Checking the Bit Architecture**(P. 701)
- ▶ **Checking the Computer Name**(P. 702)
- ▶ **Checking the Printer Port**(P. 703)
- ▶ **Checking Bidirectional Communication**(P. 704)
- ▶ **Checking the SSID to Which Your Computer is Connected**(P. 705)
- ▶ **When Printing or Sending from the Windows Store App**(P. 705)

## NOTE

- Depending on the computer that you use, the operation may differ.

## ■ Displaying the Printer Folder

### Windows Vista

[Start] ▶ select [Control Panel] ▶ [Printer].

### Windows 7/Server 2008 R2

[Start] ▶ select [Devices and Printers].

### Windows 8/Server 2012

Right-click the lower-left corner of the screen ▶ select [Control Panel] ▶ [View devices and printers].

### Windows 8.1/Server 2012 R2

Right-click [Start] ▶ select [Control Panel] ▶ [View devices and printers].

### Windows 10

[] ▶ select [Windows System] ▶ [Control Panel] ▶ [Hardware and Sound] ▶ [Devices and Printers].

### Windows Server 2008

[Start] ▶ select [Control Panel] ▶ double-click [Printers].

### Windows Server 2016

Right-click [] ▶ select [Control Panel] ▶ [Hardware] ▶ [Devices and Printers].

## ■ Enabling [Network discovery]

Enable [Network discovery] to view the computers on your network.

### Windows Vista

[Start] ▶ select [Control Panel] ▶ [View network status and tasks] ▶ select [Turn on network discovery] under [Network discovery].

### Windows 7/Server 2008 R2

[Start] ▶ select [Control Panel] ▶ [View network status and tasks] ▶ [Change advanced sharing settings] ▶ select [Turn on network discovery] under [Network discovery].

### Windows 8/Server 2012

Right-click the lower-left corner of the screen ▶ select [Control Panel] ▶ [View network status and tasks] ▶ [Change advanced sharing settings] ▶ select [Turn on network discovery] under [Network discovery].

#### Windows 8.1/Server 2012 R2

Right-click [Start] ▶ select [Control Panel] ▶ [View network status and tasks] ▶ [Change advanced sharing settings] ▶ select [Turn on network discovery] under [Network discovery].

#### Windows 10

[Windows Key] ▶ select [Windows System] ▶ [Control Panel] ▶ [View network status and tasks] ▶ [Change advanced sharing settings] ▶ select [Turn on network discovery] under [Network discovery].

#### Windows Server 2008

[Start] ▶ select [Control Panel] ▶ double-click [Network and Sharing Center] ▶ select [Turn on network discovery] under [Network discovery].

#### Windows Server 2016

Right-click [Windows Key] ▶ select [Control Panel] ▶ [View network status and tasks] ▶ [Change advanced sharing settings] ▶ select [Turn on network discovery] under [Network discovery].

## ■ Displaying Shared Printers in the Print Server

### 1 Open Windows Explorer.

#### Windows Vista/7/Server 2008

[Start] ▶ select [All Programs] or [Programs] ▶ [Accessories] ▶ [Windows Explorer].

#### Windows 8/Server 2012

Right-click the lower-left corner of the screen ▶ select [File Explorer].

#### Windows 8.1/Server 2012 R2

Right-click [Start] ▶ select [File Explorer].

#### Windows 10/Server 2016

Right-click [Windows Key] ▶ select [File Explorer].

### 2 Select the printer server in [Network] or [My Network Places].

- To view computers on the network, you may need to turn on network discovery or search the network for computers.

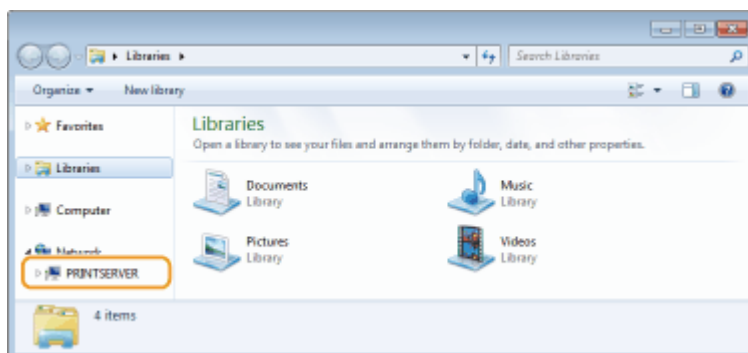

⇒ Shared printers are displayed.

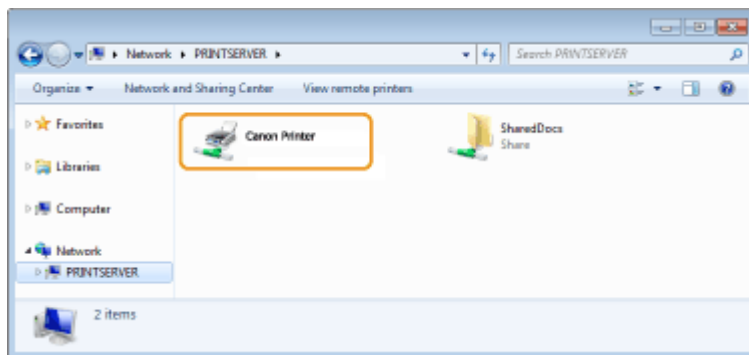

## ■ Displaying the [Software Programs/Manuals Setup] Screen

If your computer does not display the [Software Programs/Manuals Setup] screen after inserting the provided CD-ROM/DVD-ROM, follow the procedure below. The CD-ROM/DVD-ROM drive name is indicated as "D:" in this manual. The CD-ROM/DVD-ROM drive name may differ depending on the computer you are using.

### Windows Vista/7/Server 2008

[Start] ► enter "D:\MInst.exe" in [Search programs and files] or [Start Search] ► press the [ENTER] key.

### Windows 8/Server 2012

Right-click the lower-left corner of the screen ► [Run] ► Enter "D:\MInst.exe" ► click [OK]

### Windows 8.1/Server 2012 R2

Right-click [Start] ► [Run] ► Enter "D:\MInst.exe" ► click [OK]

### Windows 10

Enter "D:\MInst.exe" in the search box ► click [D:\MInst.exe] displayed as the search result.

### Windows Server 2016

Click [Windows Key] ► enter "D:\MInst.exe" ► click [D:\MInst.exe] displayed as the search result.

## ■ Printing a Test Page in Windows

You can check whether the printer driver is operational by printing a test page in Windows.

- 1 Load A4 size paper in the paper drawer. ▶ Loading Paper in the Paper Drawer(P. 140)**
- 2 Open the printer folder. ▶ Displaying the Printer Folder(P. 698)**
- 3 Right-click the printer driver icon for this machine, and click [Printer properties] or [Properties].**

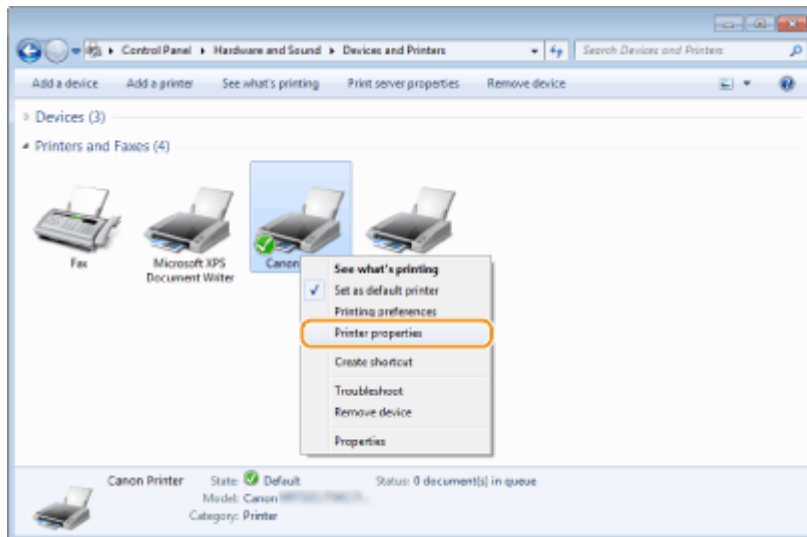

#### 4 Click [Print Test Page] in [General] tab.

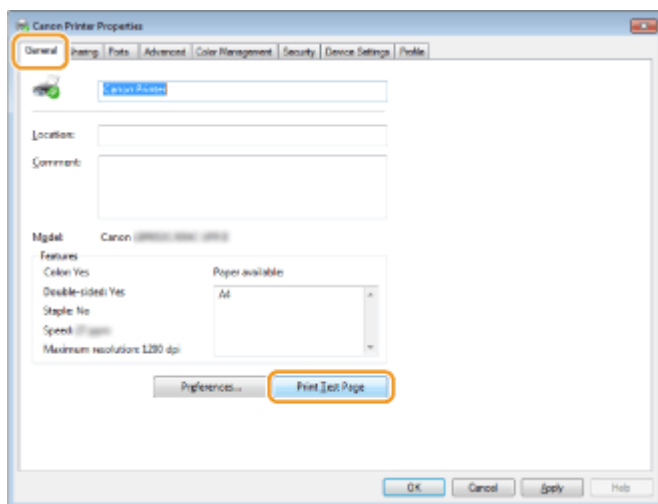

⇒ The test page is printed.

### ■ Checking the Bit Architecture

If you are not sure whether your computer is running 32-bit or 64-bit Windows follow the procedure below.

#### 1 Display [Control Panel].

**Windows Vista/7/Server 2008**  
[Start] ► select [Control Panel].

**Windows 8/Server 2012**  
Right-click the lower-left corner of the screen ► select [Control Panel].

**Windows 8.1/Server 2012 R2**  
Right-click [Start] ► select [Control Panel].

**Windows 10/Server 2016**  
Proceed to step 2.

#### 2 Display [System].

**Windows Vista/7/8/Server 2008 R2/Server 2012**

Click [System and Maintenance] or [System and Security] ► [System].

**Windows 10/Server 2016**

Click [ ] ► [Settings] ► [System] ► select [About].

**Windows Server 2008**

Double-click [System].

**3 Check the bit architecture.****For 32-bit versions**

[32-bit Operating System] is displayed.

**For 64-bit versions**

[64-bit Operating System] is displayed.

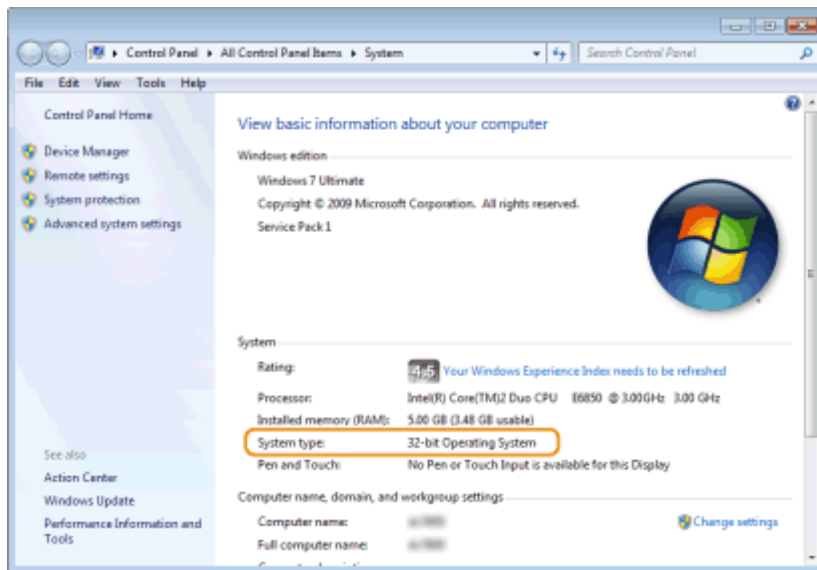
**■ Checking the Computer Name****1 Display [Control Panel].****Windows Vista/7/Server 2008**

[Start] ► select [Control Panel].

**Windows 8/Server 2012**

Right-click the lower-left corner of the screen ► select [Control Panel].

**Windows 8.1/Server 2012 R2**

Right-click [Start] ► select [Control Panel].

**Windows 10**

Click [ ] ► select [Windows System] ► [Control Panel].

**Windows Server 2016**

Right-click [ ] ► select [Control Panel].

**2 Display [System].****Windows Vista/7/8/10/Server 2008 R2/Server 2012/Server 2016**

Click [System and Maintenance] or [System and Security] ► [System].

**Windows Server 2008**  
 Double-click [System].

### 3 Check the computer name.

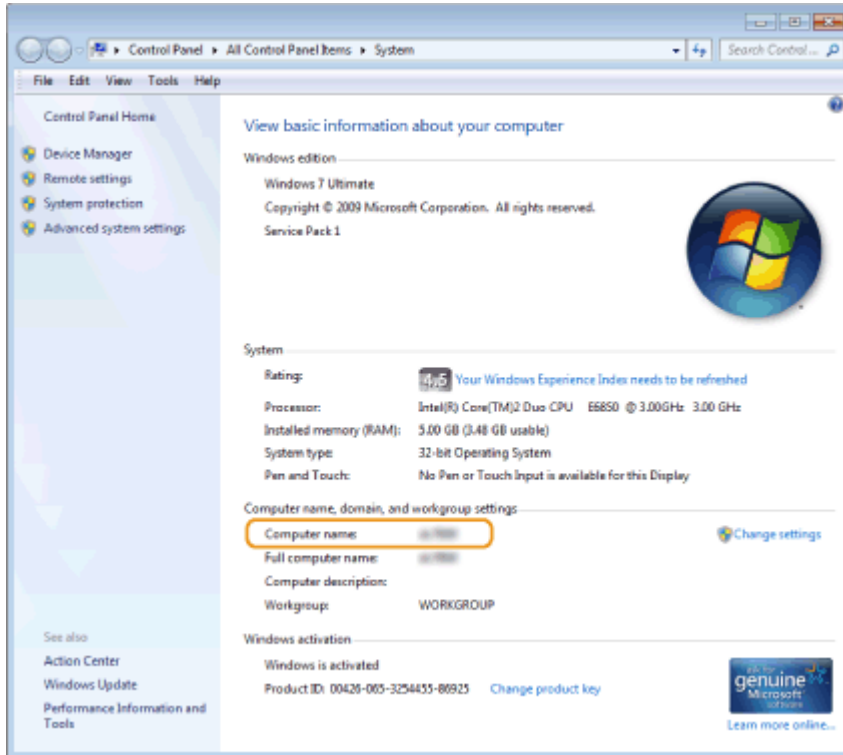

#### ■ Checking the Printer Port

**1** Open the printer folder. ▶ **Displaying the Printer Folder(P. 698)**

**2** Right-click the printer driver icon for this machine, and click [Printer properties] or [Properties].

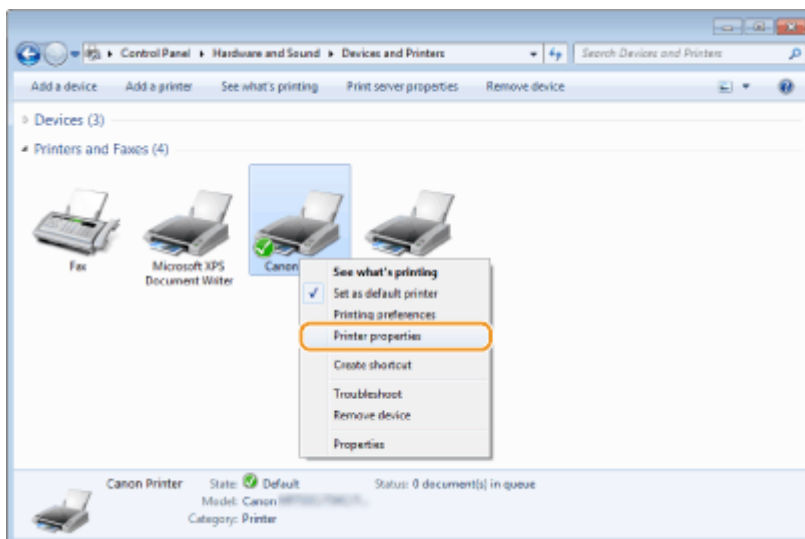

### 3 In the [Ports] tab, check that the port is selected correctly.

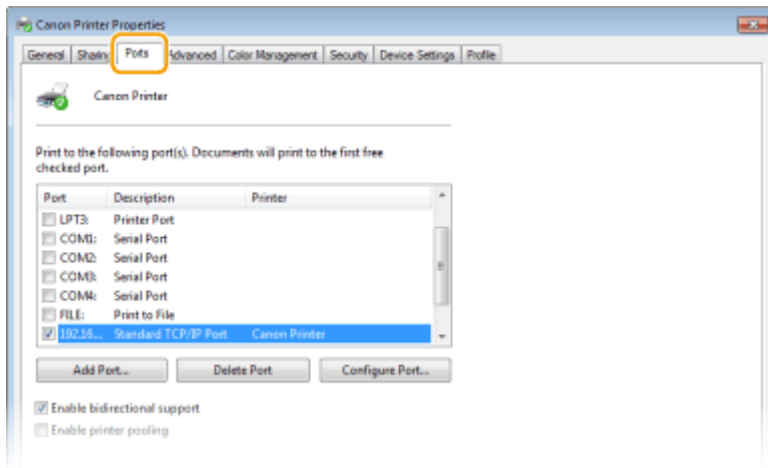

## NOTE

### If you are using a network connection and have changed the machine's IP address

- If [Description] for the selected port is [Canon MFNP Port], and the machine and the computer are on the same subnet, then the connection will be maintained. You do not need to add a new port. If it is [Standard TCP/IP Port], you need to add a new port. ▶ **Configuring Printer Ports(P. 44)**

## ■ Checking Bidirectional Communication

### 1 Open the printer folder. ▶ **Displaying the Printer Folder(P. 698)**

### 2 Right-click the printer driver icon for this machine, and click [Printer properties] or [Properties].

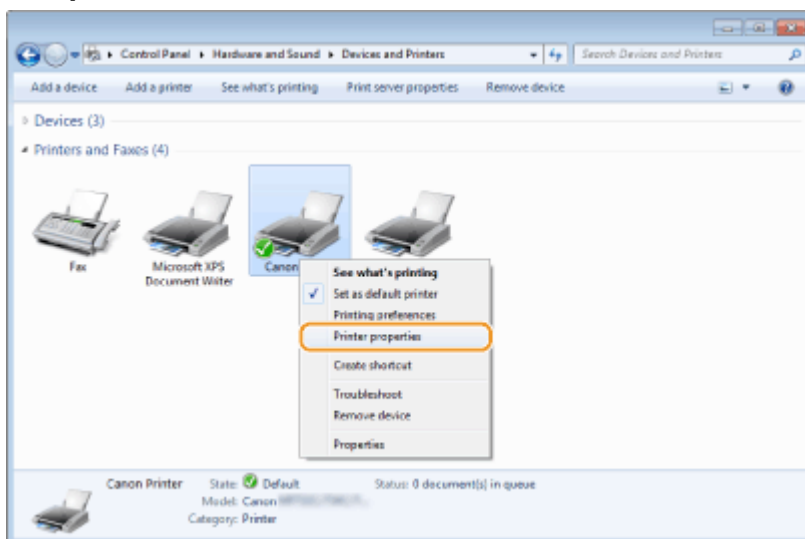

### 3 In the [Ports] tab, make sure that the [Enable bidirectional support] check box is selected.



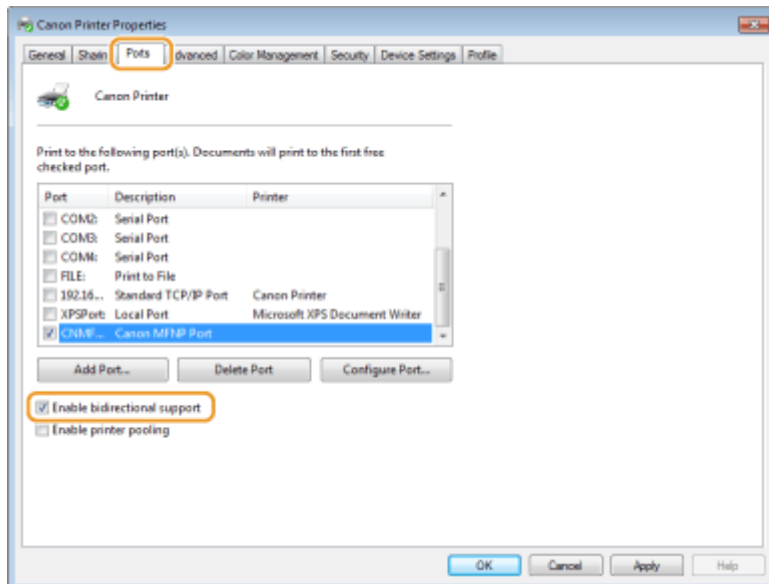

### ■ Checking the SSID to Which Your Computer is Connected

If your computer is connected to a wireless LAN network, click , , or in the system tray to display the SSID of the connected wireless LAN router.

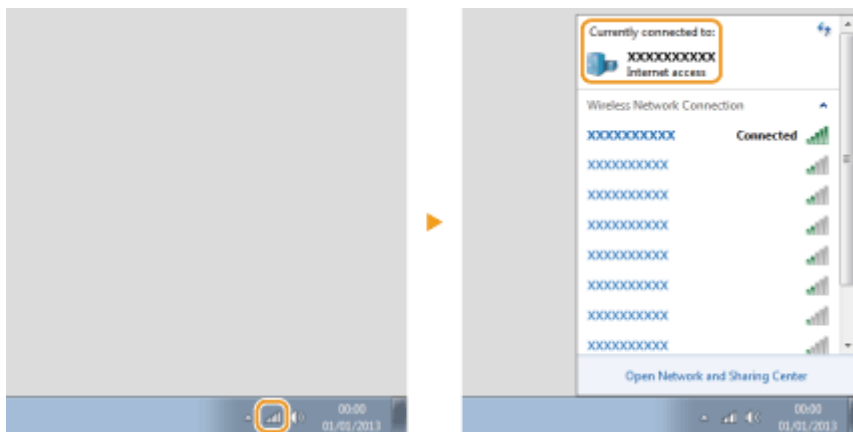

### ■ When Printing or Sending from the Windows Store App

#### Windows 8/Server 2012

Display the charms on the right side of the screen ▶ Tap or click [Devices] ▶ The driver that you use ▶ [Print].

#### Windows 8.1/Server 2012 R2

Display the charms on the right side of the screen ▶ Tap or click [Devices] ▶ [Print] ▶ The driver that you use ▶ [Print].

#### Windows 10

Tap or click [Print] on the application ▶ The driver that you use ▶ [Print].

## NOTE

- If you print a document or send a fax using this method, only a limited number of functions are available.
- If the message [The printer requires your attention. Go to the desktop to take care of it.] is displayed, go to the desktop and perform the required operations. This message appears when the machine is set to display the user name when printing documents, sending faxes or similar instances.

## Notice

261J-0E0

### IMPORTANT

#### If the operating noise concerns you

- Depending on the use environment and operating mode, if the operating noise is of concern, it is recommended that the machine be installed in a place other than the office.

#### ■ International ENERGY STAR Program



As an ENERGY STAR® Partner, Canon has determined that this product meets the ENERGY STAR Program for energy efficiency.

The ENERGY STAR Program is an international program that promotes energy saving through the use of computers and other office equipment.

The program backs the development and dissemination of products with functions that effectively reduce energy consumption. It is an open system in which business proprietors can participate voluntarily.

The targeted products are office equipment, such as computers, displays, printers, facsimiles, and copiers. The standards and logos are uniform among participating nations.

#### ■ IPv6 Ready Logo



The protocol stack included in this machine has obtained the IPv6 Ready Logo Phase-2 established by the IPv6 Forum.

#### ■ WEEE and Battery Directives



Only for European Union and EEA (Norway, Iceland and Liechtenstein)

These symbols indicate that this product is not to be disposed of with your household waste, according to the WEEE Directive (2012/19/EU), the Battery Directive (2006/66/EC) and/or national legislation implementing those Directives. If a chemical symbol is printed beneath the symbol shown above, in accordance with the Battery Directive, this indicates that a heavy metal (Hg = Mercury, Cd = Cadmium, Pb = Lead) is present in this battery or accumulator at a concentration above an applicable threshold specified in the Battery Directive.

This product should be handed over to a designated collection point, e.g., on an authorized one-for-one basis when you buy a new similar product or to an authorized collection site for recycling waste electrical and electronic equipment (EEE) and batteries and accumulators. Improper handling of this type of waste could have a possible impact on the environment and human health due to potentially hazardous substances that are generally associated with EEE. Your cooperation in the correct disposal of this product will contribute to the effective usage of natural resources.

For more information about the recycling of this product, please contact your local city office, waste authority, approved scheme or your household waste disposal service or visit [www.canon-europe.com/weee](http://www.canon-europe.com/weee), or [www.canon-europe.com/battery](http://www.canon-europe.com/battery).

## ■ Environmental Information

### Reducing your environmental impact while saving money

#### Power Consumption and Activation Time

The amount of electricity a device consumes depends on the way the device is used. This product is designed and set in a way to allow you to reduce your electricity costs. After the last print it switches to Ready Mode. In this mode it can print again immediately if required. If the product is not used for a time, the device switches to its Power Save Mode. The devices consume less power (Watt) in these modes.

If you wish to set a longer Activation Time or would like to completely deactivate the Power Save Mode, please consider that this device may then only switch to a lower energy level after a longer period of time or not at all. Canon does not recommend extending the Activation Times from the optimum ones set as default.

#### Energy Star®

The Energy Star® programme is a voluntary scheme to promote the development and purchase of energy efficient models, which help to minimise environmental impact.

Products which meet the stringent requirements of the Energy Star® programme for both environmental benefits and the amount of energy consumption will carry the Energy Star® logo accordingly.

#### Paper types

This product can be used to print on both recycled and virgin paper (certified to an environmental stewardship scheme), which complies with EN12281 or a similar quality standard. In addition it can support printing on media down to a weight of 64g/m<sup>2</sup>.

Lighter paper means less resources used and a lower environmental footprint for your printing needs.

#### Duplex printing (Standard duplex printing products only)

Duplex printing capability enables you to print on both sides automatically, and therefore helps to reduce the use of valuable resources by reducing your paper consumption.

The duplex function has been auto enabled during the set up and driver installation and Canon strongly recommends that you do not disable this function. You should continue to use the duplex function to reduce the environmental impact of your work with this product at all times.

## ■ Disclaimers

- The information in this document is subject to change without notice.
- CANON INC. MAKES NO WARRANTY OF ANY KIND WITH REGARD TO THIS MATERIAL, EITHER EXPRESS OR IMPLIED, EXCEPT AS PROVIDED HEREIN, INCLUDING WITHOUT LIMITATION, THEREOF, WARRANTIES AS TO MARKETABILITY, MERCHANTABILITY, FITNESS FOR A PARTICULAR PURPOSE OF USE, OR NON-INFRINGEMENT. CANON INC. SHALL NOT BE LIABLE FOR ANY DIRECT, INCIDENTAL, OR CONSEQUENTIAL DAMAGES OF ANY NATURE, OR LOSSES OR EXPENSES RESULTING FROM THE USE OF THIS MATERIAL.

## ■ Trademarks

Adobe, Acrobat, and Reader are registered trademarks of Adobe Systems Incorporated in the United States and/or other countries.

Apple, Bonjour, iPad, iPhone, iPod touch, Mac, macOS, OS X, Safari, AirPrint and the AirPrint logo are trademarks of Apple Inc.

Microsoft, Windows, Windows Vista, Windows Server, Internet Explorer, Word and Excel are either registered trademarks or trademarks of Microsoft Corporation in the United States and/or other countries.

IOS is a trademark or registered trademark of Cisco in the U.S. and other countries and is used under license.

Google Cloud Print, Google Chrome and Android are either registered trademarks or trademarks of Google Inc.

This product contains the Universal Font Scaling Technology or UFST® under license from Monotype Imaging, Inc.

UFST® is a trademark of Monotype Imaging, Inc. registered in the United States Patent and Trademark Office and may be registered in certain jurisdictions.

UFST: Copyright © 1989 - 1996, 1997, 2003, 2004, 2008, all rights reserved, by Monotype Imaging Inc.



Adobe, PostScript, and the PostScript logo are either registered trademarks or trademarks of Adobe Systems Incorporated in the United States and/or other countries.

Copyright © 2007 -08 Adobe Systems Incorporated. All rights reserved.

Protected by U.S. Patents 5,737,599; 5,781,785; 5,819,301; 5,929,866; 5,943,063; 6,073,148; 6,515,763; 6,639,593; 6,754,382; 7,046,403; 7,213,269; 7,242,415; Patents pending in the U.S. and other countries.

All instances of the name PostScript in the text are references to the PostScript language as defined by Adobe Systems Incorporated unless otherwise stated. The name PostScript also is used as a product trademark for Adobe Systems' implementation of the PostScript language interpreter.

Except as otherwise stated, any reference to a "PostScript printing device," "PostScript display device," or similar item refers to a printing device, display device or item (respectively) that contains PostScript technology created or licensed by Adobe Systems Incorporated and not to devices or items that purport to be merely compatible with the PostScript language.

Adobe, the Adobe logo, PostScript, the PostScript logo, and PostScript 3 are either registered trademarks or trademarks of Adobe Systems Incorporated in the United States and/or other countries.

Linux is a registered trademark of Linus Torvalds. Microsoft and Windows are either registered trademarks or trademarks of Microsoft Corporation in the United States and/or other countries.

All other trademarks are the property of their respective owners.



The PDF logo is a trademark or registered trademark of Adobe Systems Incorporated in the United States and other countries.

Copyright © 2008 Adobe Systems Incorporated. All rights reserved.

Protected by U.S. Patents 6,185,684; 6,205,549; 7,213,269; 7,272,628; 7,278,168; Patents pending in the U.S. and other countries.

All instances of the name PostScript in the text are references to the PostScript language as defined by Adobe Systems Incorporated unless otherwise stated. The name PostScript also is used as a product trademark for Adobe Systems' implementation of the PostScript language interpreter.

Except as otherwise stated, any reference to a "PostScript printing device," "PostScript display device," or similar item refers to a printing device, display device or item (respectively) that contains PostScript technology created or licensed by Adobe Systems Incorporated and not to devices or items that purport to be merely compatible with the PostScript language.

Adobe, the Adobe logo, Adobe LiveCycle® Policy Server, PostScript, the PostScript Logo, and PostScript 3 are either registered trademarks or trademarks of Adobe Systems Incorporated in the United States and/or other countries.

All other trademarks are the property of their respective owners.

All other product and brand names are registered trademarks, trademarks or service marks of their respective owners.

## ■ Copyright

Reproduction of the contents of this document in whole or in part without prior permission is prohibited.

V\_170921

This Font Software is licensed under the SIL Open Font License, Version 1.1.

This license is copied below, and is also available with a FAQ at: <http://scripts.sil.org/OFL>

-----  
SIL OPEN FONT LICENSE Version 1.1 - 26 February 2007  
-----

#### PREAMBLE

The goals of the Open Font License (OFL) are to stimulate worldwide development of collaborative font projects, to support the font creation efforts of academic and linguistic communities, and to provide a free and open framework in which fonts may be shared and improved in partnership with others.

The OFL allows the licensed fonts to be used, studied, modified and redistributed freely as long as they are not sold by themselves. The fonts, including any derivative works, can be bundled, embedded, redistributed and/or sold with any software provided that any reserved names are not used by derivative works. The fonts and derivatives, however, cannot be released under any other type of license. The requirement for fonts to remain under this license does not apply to any document created using the fonts or their derivatives.

#### DEFINITIONS

"Font Software" refers to the set of files released by the Copyright Holder(s) under this license and clearly marked as such. This may include source files, build scripts and documentation.

"Reserved Font Name" refers to any names specified as such after the copyright statement(s).

"Original Version" refers to the collection of Font Software components as distributed by the Copyright Holder(s).

"Modified Version" refers to any derivative made by adding to, deleting, or substituting -- in part or in whole -- any of the components of the Original Version, by changing formats or by porting the Font Software to a new environment.

"Author" refers to any designer, engineer, programmer, technical writer or other person who contributed to the Font Software.

#### PERMISSION & CONDITIONS

Permission is hereby granted, free of charge, to any person obtaining a copy of the Font Software, to use, study, copy, merge, embed, modify, redistribute, and sell modified and unmodified copies of the Font Software, subject to the following conditions:

- 1) Neither the Font Software nor any of its individual components, in Original or Modified Versions, may be sold by itself.
- 2) Original or Modified Versions of the Font Software may be bundled, redistributed and/or sold with any software, provided that each copy contains the above copyright notice and this license. These can be included either as stand-alone text files, human-readable headers or in the appropriate machine-readable metadata fields within text or binary files as long as those fields can be easily viewed by the user.
- 3) No Modified Version of the Font Software may use the Reserved Font Name(s) unless explicit written permission is granted by the corresponding Copyright Holder. This restriction only applies to the primary font name as presented to the users.
- 4) The name(s) of the Copyright Holder(s) or the Author(s) of the Font Software shall not be used to promote, endorse or advertise any Modified Version, except to acknowledge the contribution(s) of the Copyright Holder(s) and the Author(s) or with their explicit written permission.
- 5) The Font Software, modified or unmodified, in part or in whole, must be distributed entirely under this license, and must not be distributed under any other license. The requirement for fonts to remain under this license does not apply to any document created using the Font Software.

#### TERMINATION

This license becomes null and void if any of the above conditions are not met.

#### DISCLAIMER

THE FONT SOFTWARE IS PROVIDED "AS IS", WITHOUT WARRANTY OF ANY KIND, EXPRESS OR IMPLIED, INCLUDING BUT NOT LIMITED TO ANY WARRANTIES OF MERCHANTABILITY, FITNESS FOR A PARTICULAR PURPOSE AND NONINFRINGEMENT OF COPYRIGHT, PATENT, TRADEMARK, OR OTHER RIGHT. IN NO EVENT SHALL THE COPYRIGHT HOLDER BE LIABLE FOR ANY CLAIM, DAMAGES OR OTHER LIABILITY, INCLUDING ANY GENERAL, SPECIAL, INDIRECT, INCIDENTAL, OR CONSEQUENTIAL DAMAGES, WHETHER IN AN ACTION OF CONTRACT, TORT OR OTHERWISE, ARISING FROM, OUT OF THE USE OR INABILITY TO USE THE FONT SOFTWARE OR FROM OTHER DEALINGS IN THE FONT SOFTWARE.

## Third-Party Services

If you use third-party services through the PRODUCT, use of the services are subjected the conditions below.

When you access and/or obtain some third party content (such as text, images, videos, audios, or software) through the SOFTWARE, except as expressly permitted by the content owner or by applicable law, you may not (a) scrape, build databases or otherwise create permanent copies of such content, or keep cached copies longer than permitted by the cache header; (b) copy, translate, modify, create a derivative work of, sell, lease, lend, convey, distribute, publicly display or sublicense to any third party; (c) misrepresent the source or ownership; and (d) remove, obscure, or alter any copyright, trademark or other proprietary rights notices, falsify or delete any author attributions, legal notices or other labels of the origin or source of material.



## The Software Subjected to the Other License Conditions

Please refer to Table of Software and respective License terms below, for more detail and corresponding license conditions.

Table of Software

Names of Software	Terms and Conditions of the License: See Page
Adobe PostScript 3	3
Adobe PDF Scan Library	10
expat	13
HarfBuzz 2012-07-30	14
libjingle	15
Lua	16
LuaSocket	17
MD4	18
Net-SNMP	19
OpenSSL	27

## Adobe PostScript 3

Copyright 2007-2008 Adobe Systems Incorporated and its licensors. All rights reserved.

Portions include software under the following terms:

---

This product contains either BSAFE and/or TIPEM software by RSA Security Inc.

---

Portions of Pool.c\_Copyright 1987 - NeXT, Inc., and portions of Graphics.c\_Copyright 1988 NeXT, Inc. as an unpublished work. All Rights Reserved.

---

The Apache Software License, Version 1.1

This product includes software developed by the Apache Software Foundation (<http://www.apache.org/>).

Portions Copyright (c) 1998-2000 The Apache Software Foundation. All rights reserved.

Redistribution and use in source and binary forms, with or without modification, are permitted provided that the following conditions are met:

1. Redistributions of source code must retain the above copyright notice, this list of conditions and the following disclaimer.
2. Redistributions in binary form must reproduce the above copyright notice, this list of conditions and the following disclaimer in the documentation and/or other materials provided with the distribution.
3. The end-user documentation included with the redistribution, if any, must include the following acknowledgment:

"This product includes software developed by the Apache Software Foundation (<http://www.apache.org/>)."

Alternately, this acknowledgment may appear in the software itself, if and wherever such third-party acknowledgments normally appear.

4. The names "Xerces" and "Apache Software Foundation" must not be used to endorse or promote products derived from this software without prior written permission. For written permission, please contact [apache@apache.org](mailto:apache@apache.org).
5. Products derived from this software may not be called "Apache", nor may "Apache" appear in their name, without prior written permission of the Apache Software Foundation.

THIS SOFTWARE IS PROVIDED ``AS IS" AND ANY EXPRESSED OR IMPLIED WARRANTIES, INCLUDING, BUT NOT LIMITED TO, THE IMPLIED WARRANTIES OF MERCHANTABILITY AND FITNESS FOR A PARTICULAR PURPOSE ARE DISCLAIMED. IN NO EVENT SHALL THE APACHE SOFTWARE FOUNDATION OR ITS CONTRIBUTORS BE LIABLE FOR ANY DIRECT, INDIRECT, INCIDENTAL, SPECIAL, EXEMPLARY, OR CONSEQUENTIAL DAMAGES (INCLUDING, BUT NOT LIMITED TO,

PROCUREMENT OF SUBSTITUTE GOODS OR SERVICES; LOSS OF USE, DATA, OR PROFITS; OR BUSINESS INTERRUPTION) HOWEVER CAUSED AND ON ANY THEORY OF LIABILITY, WHETHER IN CONTRACT, STRICT LIABILITY, OR TORT (INCLUDING NEGLIGENCE OR OTHERWISE) ARISING IN ANY WAY OUT OF THE USE OF THIS SOFTWARE, EVEN IF ADVISED OF THE POSSIBILITY OF SUCH DAMAGE.

This software consists of voluntary contributions made by many individuals on behalf of the Apache Software Foundation and was originally based on software copyright (c) 1999, International Business Machines, Inc., <http://www.ibm.com>. For more information on the Apache Software Foundation, please see <http://www.apache.org/>.

---

This product includes software developed by the University of California, Berkeley and its contributors. Portions Copyright (c) 1990 The Regents of the University of California. All rights reserved.

Redistribution and use in source and binary forms, with or without modification, are permitted provided that the following conditions are met:

1. Redistributions of source code must retain the above copyright notice, this list of conditions and the following disclaimer.
2. Redistributions in binary form must reproduce the above copyright notice, this list of conditions and the following disclaimer in the documentation and/or other materials provided with the distribution.
3. All advertising materials mentioning features or use of this software must display the following acknowledgement:

This product includes software developed by the University of California, Berkeley and its contributors.

4. Neither the name of the University nor the names of its contributors may be used to endorse or promote products derived from this software without specific prior written permission.

THIS SOFTWARE IS PROVIDED BY THE REGENTS AND CONTRIBUTORS "AS IS" AND ANY EXPRESS OR IMPLIED WARRANTIES, INCLUDING, BUT NOT LIMITED TO, THE IMPLIED WARRANTIES OF MERCHANTABILITY AND FITNESS FOR A PARTICULAR PURPOSE ARE DISCLAIMED. IN NO EVENT SHALL THE REGENTS OR CONTRIBUTORS BE LIABLE FOR ANY DIRECT, INDIRECT, INCIDENTAL, SPECIAL, EXEMPLARY, OR CONSEQUENTIAL DAMAGES (INCLUDING, BUT NOT LIMITED TO, PROCUREMENT OF SUBSTITUTE GOODS OR SERVICES; LOSS OF USE, DATA, OR PROFITS; OR BUSINESS INTERRUPTION) HOWEVER CAUSED AND ON ANY THEORY OF LIABILITY, WHETHER IN CONTRACT, STRICT LIABILITY, OR TORT (INCLUDING NEGLIGENCE OR OTHERWISE) ARISING IN ANY WAY OUT OF THE USE OF THIS SOFTWARE, EVEN IF ADVISED OF THE POSSIBILITY OF SUCH DAMAGE.

---

Portions Copyright (c) 1985, 1986 The Regents of the University of California. All rights reserved.

This code is derived from software contributed to Berkeley by James A. Woods, derived from original work by Spencer Thomas and Joseph Orost.

Redistribution and use in source and binary forms are permitted provided that the above copyright notice and this paragraph are duplicated in all such forms and that any documentation, advertising materials, and other materials related to such distribution and use acknowledge that the software was developed by the University of California, Berkeley. The name of the University may not be used to endorse or promote products derived from this software without specific prior written permission.

THIS SOFTWARE IS PROVIDED ``AS IS" AND WITHOUT ANY EXPRESS OR IMPLIED WARRANTIES, INCLUDING, WITHOUT LIMITATION, THE IMPLIED WARRANTIES OF MERCHANTABILITY AND FITNESS FOR A PARTICULAR PURPOSE.

Portions Copyright (c) 1993 X Consortium

Permission is hereby granted, free of charge, to any person obtaining a copy of this software and associated documentation files (the "Software"), to deal in the Software without restriction, including without limitation the rights to use, copy, modify, merge, publish, distribute, sublicense, and/or sell copies of the Software, and to permit persons to whom the Software is furnished to do so, subject to the following conditions:

The above copyright notice and this permission notice shall be included in all copies or substantial portions of the Software.

THE SOFTWARE IS PROVIDED "AS IS", WITHOUT WARRANTY OF ANY KIND, EXPRESS OR IMPLIED, INCLUDING BUT NOT LIMITED TO THE WARRANTIES OF MERCHANTABILITY, FITNESS FOR A PARTICULAR PURPOSE AND NONINFRINGEMENT. IN NO EVENT SHALL THE X CONSORTIUM BE LIABLE FOR ANY CLAIM, DAMAGES OR OTHER LIABILITY, WHETHER IN AN ACTION OF CONTRACT, TORT OR OTHERWISE, ARISING FROM, OUT OF OR IN CONNECTION WITH THE SOFTWARE OR THE USE OR OTHER DEALINGS IN THE SOFTWARE.

Except as contained in this notice, the name of the X Consortium shall not be used in advertising or otherwise to promote the sale, use or other dealings in this Software without prior written authorization from the X Consortium.

---

NOTICE REGARDING SABLON

March 27, 2003

Portions of this product are based on Modifications created from the Original Code known as the "Sablotron XSLT Processor". The Sablotron XSLT Processor is subject to the Mozilla Public License Version 1.1 (the "License"). You may obtain a copy of the License at <http://www.mozilla.org/MPL/>

Software distributed under the License is distributed on an "AS IS" basis, WITHOUT WARRANTY OF ANY KIND, either express or implied. See the License for the specific language governing rights and limitations under the License.

The Original Code is the Sablotron XSLT Processor.

The Initial Developer of the Original Code is Ginger Alliance Ltd. Portions created by Ginger Alliance are Copyright (C) 2000 Ginger Alliance Ltd. All Rights Reserved.

Pursuant to sections 3.2 and 3.6 of the License, the Modifications created by Adobe Systems Incorporated are available as Source Code. The Modifications may be downloaded via the Internet from:

<http://partners.adobe.com/asn/tech/xml/sablotron/index.jsp>

The Original Code may be downloaded via the Internet from:

<https://sourceforge.net/projects/sablotron/>

---

This product includes software developed by the University of California, Berkeley and its contributors. Portions Copyright (c) 1982, 1986, 1987, 1988, 1989, 1990, 1991, 1992, 1993, 1994 The Regents of the University of California. All rights reserved.

Redistribution and use in source and binary forms, with or without modification, are permitted provided that the following conditions are met:

1. Redistributions of source code must retain the above copyright notice, this list of conditions and the following disclaimer.
2. Redistributions in binary form must reproduce the above copyright notice, this list of conditions and the following disclaimer in the documentation and/or other materials provided with the distribution.
3. All advertising materials mentioning features or use of this software must display the following acknowledgement: This product includes software developed by the University of California, Berkeley and its contributors.
4. Neither the name of the University nor the names of its contributors may be used to endorse or promote

products derived from this software without specific prior written permission.

THIS SOFTWARE IS PROVIDED BY THE REGENTS AND CONTRIBUTORS "AS IS" AND ANY EXPRESS OR IMPLIED WARRANTIES, INCLUDING, BUT NOT LIMITED TO, THE IMPLIED WARRANTIES OF MERCHANTABILITY AND FITNESS FOR A PARTICULAR PURPOSE ARE DISCLAIMED. IN NO EVENT SHALL THE REGENTS OR CONTRIBUTORS BE LIABLE FOR ANY DIRECT, INDIRECT, INCIDENTAL, SPECIAL, EXEMPLARY, OR CONSEQUENTIAL DAMAGES (INCLUDING, BUT NOT LIMITED TO, PROCUREMENT OF SUBSTITUTE GOODS OR SERVICES; LOSS OF USE, DATA, OR PROFITS; OR BUSINESS INTERRUPTION) HOWEVER CAUSED AND ON ANY THEORY OF LIABILITY, WHETHER IN CONTRACT, STRICT LIABILITY, OR TORT (INCLUDING NEGLIGENCE OR OTHERWISE) ARISING IN ANY WAY OUT OF THE USE OF THIS SOFTWARE, EVEN IF ADVISED OF THE POSSIBILITY OF SUCH DAMAGE.

---

Portions Copyright (c) 2001 by Andrei Alexandrescu. This code accompanies the book:

Alexandrescu, Andrei. "Modern C++ Design: Generic Programming and Design Patterns Applied". Copyright (c) 2001. Addison-Wesley.

Permission to use, copy, modify, distribute and sell this software for any purpose is hereby granted without fee, provided that the above copyright notice appear in all copies and that both that copyright notice and this permission notice appear in supporting documentation. The author or Addison-Wesley Longman make no representations about the suitability of this software for any purpose. It is provided "as is" without express or implied warranty.

---

Portions developed by the University of California, Berkeley.

---

Portions Copyright © 1991-2005 Unicode, Inc. All rights reserved. Distributed under the Terms of Use in <http://www.unicode.org/copyright.html>.

Permission is hereby granted, free of charge, to any person obtaining a copy of the Unicode data files and associated documentation (the "Data Files") or Unicode software and associated documentation (the "Software") to deal in the Data Files or Software without restriction, including without limitation the rights to use, copy, modify, merge, publish, distribute, and/or sell copies of the Data Files or Software, and to permit persons to whom the Data Files or Software are furnished to do so, provided that (a) the above copyright notice(s) and this permission notice appear in all copies of the Data Files or Software, (b) both the above copyright notice(s) and this permission notice appear in associated documentation, and (c) there is clear notice in each modified Data File or in the Software as well as in the documentation associated with the Data File(s) or Software that the data or software has been modified.

THE DATA FILES AND SOFTWARE ARE PROVIDED "AS IS", WITHOUT WARRANTY OF ANY KIND,

EXPRESS OR IMPLIED, INCLUDING BUT NOT LIMITED TO THE WARRANTIES OF MERCHANTABILITY, FITNESS FOR A PARTICULAR PURPOSE AND NONINFRINGEMENT OF THIRD PARTY RIGHTS. IN NO EVENT SHALL THE COPYRIGHT HOLDER OR HOLDERS INCLUDED IN THIS NOTICE BE LIABLE FOR ANY CLAIM, OR ANY SPECIAL INDIRECT OR CONSEQUENTIAL DAMAGES, OR ANY DAMAGES WHATSOEVER RESULTING FROM LOSS OF USE, DATA OR PROFITS, WHETHER IN AN ACTION OF CONTRACT, NEGLIGENCE OR OTHER TORTIOUS ACTION, ARISING OUT OF OR IN CONNECTION WITH THE USE OR PERFORMANCE OF THE DATA FILES OR SOFTWARE.

Except as contained in this notice, the name of a copyright holder shall not be used in advertising or otherwise to promote the sale, use or other dealings in these Data Files or Software without prior written authorization of the copyright holder.

Unicode and the Unicode logo are trademarks of Unicode, Inc., and may be registered in some jurisdictions. All other trademarks and registered trademarks mentioned herein are the property of their respective owners.

---

Adobe shall retain and reproduce, and require its Sublicensees to retain and reproduce JIM's following copyright notice within each copy of the licensed programs in any form, in whole or in part: "© 1981, 1990 JMI Consultants, Inc. All rights reserved."

---

This product includes software developed by the University of California, Berkeley and its contributors. Portions Copyright (c) 1990, 1993 The Regents of the University of California. All rights reserved.

This code is derived from software contributed to Berkeley by Chris Torek.

Redistribution and use in source and binary forms, with or without modification, are permitted provided that the following conditions are met:

1. Redistributions of source code must retain the above copyright notice, this list of conditions and the following disclaimer.
2. Redistributions in binary form must reproduce the above copyright notice, this list of conditions and the following disclaimer in the documentation and/or other materials provided with the distribution.
3. All advertising materials mentioning features or use of this software must display the following acknowledgement:

This product includes software developed by the University of California, Berkeley and its contributors.

4. Neither the name of the University nor the names of its contributors may be used to endorse or promote products derived from this software without specific prior written permission.

THIS SOFTWARE IS PROVIDED BY THE REGENTS AND CONTRIBUTORS "AS IS" AND ANY EXPRESS

OR IMPLIED WARRANTIES, INCLUDING, BUT NOT LIMITED TO, THE IMPLIED WARRANTIES OF MERCHANTABILITY AND FITNESS FOR A PARTICULAR PURPOSE ARE DISCLAIMED. IN NO EVENT SHALL THE REGENTS OR CONTRIBUTORS BE LIABLE FOR ANY DIRECT, INDIRECT, INCIDENTAL, SPECIAL, EXEMPLARY, OR CONSEQUENTIAL DAMAGES (INCLUDING, BUT NOT LIMITED TO, PROCUREMENT OF SUBSTITUTE GOODS OR SERVICES; LOSS OF USE, DATA, OR PROFITS; OR BUSINESS INTERRUPTION) HOWEVER CAUSED AND ON ANY THEORY OF LIABILITY, WHETHER IN CONTRACT, STRICT LIABILITY, OR TORT (INCLUDING NEGLIGENCE OR OTHERWISE) ARISING IN ANY WAY OUT OF THE USE OF THIS SOFTWARE, EVEN IF ADVISED OF THE POSSIBILITY OF SUCH DAMAGE.

---

The Loki Library

Portions Copyright (c) 2001 by Andrei Alexandrescu // This code accompanies the book: Alexandrescu, Andrei. "Modern C++ Design: Generic Programming and Design Patterns Applied". Copyright (c) 2001. Addison-Wesley.

Permission to use, copy, modify, distribute and sell this software for any purpose is hereby granted without fee, provided that the above copyright notice appear in all copies and that both that copyright notice and this permission notice appear in supporting documentation. The author or Addison-Wesley Longman make no representations about the suitability of this software for any purpose. It is provided "as is" without express or implied warranty.

---

Updated Information/Additional Third Party Code Information available at <http://www.adobe.com/go/thirdparty> .

---



Portions use software under the following terms:

---

This product contains either BSAFE and/or TIPEM software by RSA Security Inc.

---

This product includes software developed by the Apache Software Foundation (<http://www.apache.org/>).  
Copyright (c) 1998-2000 The Apache Software Foundation. All rights reserved.

Redistribution and use in source and binary forms, with or without modification, are permitted provided that the following conditions are met:

1. Redistributions of source code must retain the above copyright notice, this list of conditions and the following disclaimer.
2. Redistributions in binary form must reproduce the above copyright notice, this list of conditions and the following disclaimer in the documentation and/or other materials provided with the distribution.
3. The end-user documentation included with the redistribution, if any, must include the following acknowledgment:

"This product includes software developed by the Apache Software Foundation (<http://www.apache.org/>)."

Alternately, this acknowledgment may appear in the software itself, if and wherever such third-party acknowledgments normally appear.

4. The names "Xerces" and "Apache Software Foundation" must not be used to endorse or promote products derived from this software without prior written permission. For written permission, please contact [apache@apache.org](mailto:apache@apache.org).
5. Products derived from this software may not be called "Apache", nor may "Apache" appear in their name, without prior written permission of the Apache Software Foundation.

THIS SOFTWARE IS PROVIDED ``AS IS" AND ANY EXPRESSED OR IMPLIED WARRANTIES, INCLUDING, BUT NOT LIMITED TO, THE IMPLIED WARRANTIES OF MERCHANTABILITY AND FITNESS FOR A PARTICULAR PURPOSE ARE DISCLAIMED. IN NO EVENT SHALL THE APACHE SOFTWARE FOUNDATION OR ITS CONTRIBUTORS BE LIABLE FOR ANY DIRECT, INDIRECT, INCIDENTAL, SPECIAL, EXEMPLARY, OR CONSEQUENTIAL DAMAGES (INCLUDING, BUT NOT LIMITED TO, PROCUREMENT OF SUBSTITUTE GOODS OR SERVICES; LOSS OF USE, DATA, OR PROFITS; OR BUSINESS INTERRUPTION) HOWEVER CAUSED AND ON ANY THEORY OF LIABILITY, WHETHER IN CONTRACT, STRICT LIABILITY, OR TORT (INCLUDING NEGLIGENCE OR OTHERWISE) ARISING IN ANY WAY OUT OF THE USE OF THIS SOFTWARE, EVEN IF ADVISED OF THE POSSIBILITY OF SUCH DAMAGE.

This software consists of voluntary contributions made by many individuals on behalf of the Apache Software Foundation and was originally based on software copyright (c) 1999, International Business Machines, Inc., <http://www.ibm.com>. For more information on the Apache Software Foundation, please see <http://www.apache.org/>.

---

March 27, 2003

Portions of this product are based on Modifications created from the Original Code known as the "Sablotron XSLT Processor". The Sablotron XSLT Processor is subject to the Mozilla Public License Version 1.1 (the "License"). You may obtain a copy of the License at <http://www.mozilla.org/MPL/>

Software distributed under the License is distributed on an "AS IS" basis, WITHOUT WARRANTY OF ANY KIND, either express or implied. See the License for the specific language governing rights and limitations under the License.

The Original Code is the Sablotron XSLT Processor.

The Initial Developer of the Original Code is Ginger Alliance Ltd. Portions created by Ginger Alliance are Copyright (C) 2000 Ginger Alliance Ltd. All Rights Reserved.

Pursuant to sections 3.2 and 3.6 of the License, the Modifications created by Adobe Systems Incorporated are available as Source Code. The Modifications may be downloaded via the Internet from:

<http://partners.adobe.com/asn/tech/xml/sablotron/index.jsp>

The Original Code may be downloaded via the Internet from:

<https://sourceforge.net/projects/sablotron/>

---

Portions Copyright (c) 1997-1999 Silicon Graphics Computer Systems, Inc.

Permission to use, copy, modify, distribute and sell this software and its documentation for any purpose is hereby granted without fee, provided that the above copyright notice appear in all copies and that both that copyright notice and this permission notice appear in supporting documentation. Silicon Graphics makes no representations about the suitability of this software for any purpose. It is provided "as is" without express or implied warranty.

---

The Loki Library

Portions Copyright (c) 2001 by Andrei Alexandrescu . This code accompanies the book: Alexandrescu, Andrei. "Modern C++ Design: Generic Programming and Design Patterns Applied".

Portions Copyright (c) 2001. Addison-Wesley. Permission to use, copy, modify, distribute and sell this software for any purpose is hereby granted without fee, provided that the above copyright notice appear in all copies and that both that copyright notice and this permission notice appear in supporting documentation. The author or Addison-Wesley Longman make no representations about the suitability of this software for any purpose. It is provided "as is" without express or implied warranty.

---

Updated Information/Additional Third Party Code Information available at <http://www.adobe.com/go/thirdparty> .

---

expat

Copyright (c) 1998, 1999, 2000 Thai Open Source Software Center Ltd  
and Clark Cooper

Copyright (c) 2001, 2002, 2003, 2004, 2005, 2006 Expat maintainers.

Permission is hereby granted, free of charge, to any person obtaining a copy of this software and associated documentation files (the "Software"), to deal in the Software without restriction, including without limitation the rights to use, copy, modify, merge, publish, distribute, sublicense, and/or sell copies of the Software, and to permit persons to whom the Software is furnished to do so, subject to the following conditions:

The above copyright notice and this permission notice shall be included in all copies or substantial portions of the Software.

THE SOFTWARE IS PROVIDED "AS IS", WITHOUT WARRANTY OF ANY KIND, EXPRESS OR IMPLIED, INCLUDING BUT NOT LIMITED TO THE WARRANTIES OF MERCHANTABILITY, FITNESS FOR A PARTICULAR PURPOSE AND NONINFRINGEMENT. IN NO EVENT SHALL THE AUTHORS OR COPYRIGHT HOLDERS BE LIABLE FOR ANY CLAIM, DAMAGES OR OTHER LIABILITY, WHETHER IN AN ACTION OF CONTRACT, TORT OR OTHERWISE, ARISING FROM, OUT OF OR IN CONNECTION WITH THE SOFTWARE OR THE USE OR OTHER DEALINGS IN THE SOFTWARE.

HarfBuzz 2012-07-30

Copyright (C) 2006 Behdad Esfahbod

Copyright (C) 1998-2004 David Turner and Werner Lemberg

Copyright (C) 2008 Nokia Corporation and/or its subsidiary(-ies)

Copyright (C) 2004,2007 Red Hat, Inc.

Permission is hereby granted, without written agreement and without license or royalty fees, to use, copy, modify, and distribute this software and its documentation for any purpose, provided that the above copyright notice and the following two paragraphs appear in all copies of this software.

IN NO EVENT SHALL THE COPYRIGHT HOLDER BE LIABLE TO ANY PARTY FOR DIRECT, INDIRECT, SPECIAL, INCIDENTAL, OR CONSEQUENTIAL DAMAGES ARISING OUT OF THE USE OF THIS SOFTWARE AND ITS DOCUMENTATION, EVEN IF THE COPYRIGHT HOLDER HAS BEEN ADVISED OF THE POSSIBILITY OF SUCH DAMAGE.

THE COPYRIGHT HOLDER SPECIFICALLY DISCLAIMS ANY WARRANTIES, INCLUDING, BUT NOT LIMITED TO, THE IMPLIED WARRANTIES OF MERCHANTABILITY AND FITNESS FOR A PARTICULAR PURPOSE. THE SOFTWARE PROVIDED HEREUNDER IS ON AN "AS IS" BASIS, AND THE COPYRIGHT HOLDER HAS NO OBLIGATION TO PROVIDE MAINTENANCE, SUPPORT, UPDATES, ENHANCEMENTS, OR MODIFICATIONS.

libjingle

Copyright 2004--2007, Google Inc.

Redistribution and use in source and binary forms, with or without modification, are permitted provided that the following conditions are met:

1. Redistributions of source code must retain the above copyright notice, this list of conditions and the following disclaimer.
2. Redistributions in binary form must reproduce the above copyright notice, this list of conditions and the following disclaimer in the documentation and/or other materials provided with the distribution.
3. The name of the author may not be used to endorse or promote products derived from this software without specific prior written permission.

THIS SOFTWARE IS PROVIDED BY THE AUTHOR "AS IS" AND ANY EXPRESS OR IMPLIED WARRANTIES, INCLUDING, BUT NOT LIMITED TO, THE IMPLIED WARRANTIES OF MERCHANTABILITY AND FITNESS FOR A PARTICULAR PURPOSE ARE DISCLAIMED. IN NO EVENT SHALL THE AUTHOR BE LIABLE FOR ANY DIRECT, INDIRECT, INCIDENTAL, SPECIAL, EXEMPLARY, OR CONSEQUENTIAL DAMAGES (INCLUDING, BUT NOT LIMITED TO, PROCUREMENT OF SUBSTITUTE GOODS OR SERVICES; LOSS OF USE, DATA, OR PROFITS; OR BUSINESS INTERRUPTION) HOWEVER CAUSED AND ON ANY THEORY OF LIABILITY, WHETHER IN CONTRACT, STRICT LIABILITY, OR TORT (INCLUDING NEGLIGENCE OR OTHERWISE) ARISING IN ANY WAY OUT OF THE USE OF THIS SOFTWARE, EVEN IF ADVISED OF THE POSSIBILITY OF SUCH DAMAGE.

## Lua

Copyright © 1994–2014 Lua.org, PUC-Rio.

Permission is hereby granted, free of charge, to any person obtaining a copy of this software and associated documentation files (the "Software"), to deal in the Software without restriction, including without limitation the rights to use, copy, modify, merge, publish, distribute, sublicense, and/or sell copies of the Software, and to permit persons to whom the Software is furnished to do so, subject to the following conditions:

The above copyright notice and this permission notice shall be included in all copies or substantial portions of the Software.

THE SOFTWARE IS PROVIDED "AS IS", WITHOUT WARRANTY OF ANY KIND, EXPRESS OR IMPLIED, INCLUDING BUT NOT LIMITED TO THE WARRANTIES OF MERCHANTABILITY, FITNESS FOR A PARTICULAR PURPOSE AND NONINFRINGEMENT. IN NO EVENT SHALL THE AUTHORS OR COPYRIGHT HOLDERS BE LIABLE FOR ANY CLAIM, DAMAGES OR OTHER LIABILITY, WHETHER IN AN ACTION OF CONTRACT, TORT OR OTHERWISE, ARISING FROM, OUT OF OR IN CONNECTION WITH THE SOFTWARE OR THE USE OR OTHER DEALINGS IN THE SOFTWARE.

## LuaSocket

LuaSocket 2.0.2 license

Copyright © 2004-2007 Diego Nehab

Permission is hereby granted, free of charge, to any person obtaining a copy of this software and associated documentation files (the "Software"), to deal in the Software without restriction, including without limitation the rights to use, copy, modify, merge, publish, distribute, sublicense, and/or sell copies of the Software, and to permit persons to whom the Software is furnished to do so, subject to the following conditions:

The above copyright notice and this permission notice shall be included in all copies or substantial portions of the Software.

THE SOFTWARE IS PROVIDED "AS IS", WITHOUT WARRANTY OF ANY KIND, EXPRESS OR IMPLIED, INCLUDING BUT NOT LIMITED TO THE WARRANTIES OF MERCHANTABILITY, FITNESS FOR A PARTICULAR PURPOSE AND NONINFRINGEMENT. IN NO EVENT SHALL THE AUTHORS OR COPYRIGHT HOLDERS BE LIABLE FOR ANY CLAIM, DAMAGES OR OTHER LIABILITY, WHETHER IN AN ACTION OF CONTRACT, TORT OR OTHERWISE, ARISING FROM, OUT OF OR IN CONNECTION WITH THE SOFTWARE OR THE USE OR OTHER DEALINGS IN THE SOFTWARE.



MD4

"RSA Data Security, Inc. MD4 Message-Digest Algorithm"

## Net-SNMP

Various copyrights apply to this package, listed in various separate parts below. Please make sure that you read all the parts.

---- Part 1: CMU/UCD copyright notice: (BSD like) -----

Copyright 1989, 1991, 1992 by Carnegie Mellon University

Derivative Work - 1996, 1998-2000

Copyright 1996, 1998-2000 The Regents of the University of California

All Rights Reserved

Permission to use, copy, modify and distribute this software and its documentation for any purpose and without fee is hereby granted, provided that the above copyright notice appears in all copies and that both that copyright notice and this permission notice appear in supporting documentation, and that the name of CMU and The Regents of the University of California not be used in advertising or publicity pertaining to distribution of the software without specific written permission.

CMU AND THE REGENTS OF THE UNIVERSITY OF CALIFORNIA DISCLAIM ALL WARRANTIES WITH REGARD TO THIS SOFTWARE, INCLUDING ALL IMPLIED WARRANTIES OF MERCHANTABILITY AND FITNESS. IN NO EVENT SHALL CMU OR THE REGENTS OF THE UNIVERSITY OF CALIFORNIA BE LIABLE FOR ANY SPECIAL, INDIRECT OR CONSEQUENTIAL DAMAGES OR ANY DAMAGES WHATSOEVER RESULTING FROM THE LOSS OF USE, DATA OR PROFITS, WHETHER IN AN ACTION OF CONTRACT, NEGLIGENCE OR OTHER TORTIOUS ACTION, ARISING OUT OF OR IN CONNECTION WITH THE USE OR PERFORMANCE OF THIS SOFTWARE.

---- Part 2: Networks Associates Technology, Inc copyright notice (BSD) -----

Copyright (c) 2001-2003, Networks Associates Technology, Inc  
All rights reserved.

Redistribution and use in source and binary forms, with or without modification, are permitted provided that the following conditions are met:

- \* Redistributions of source code must retain the above copyright notice, this list of conditions and the following disclaimer.
- \* Redistributions in binary form must reproduce the above copyright notice, this list of conditions and the following disclaimer in the documentation and/or other materials provided with the distribution.
- \* Neither the name of the Networks Associates Technology, Inc nor the names of its contributors may be used to endorse or promote products derived from this software without specific prior written permission.

THIS SOFTWARE IS PROVIDED BY THE COPYRIGHT HOLDERS AND CONTRIBUTORS "AS IS" AND ANY EXPRESS OR IMPLIED WARRANTIES, INCLUDING, BUT NOT LIMITED TO, THE IMPLIED WARRANTIES OF MERCHANTABILITY AND FITNESS FOR A PARTICULAR PURPOSE ARE DISCLAIMED. IN NO EVENT SHALL THE COPYRIGHT HOLDERS OR CONTRIBUTORS BE LIABLE FOR ANY DIRECT, INDIRECT, INCIDENTAL, SPECIAL, EXEMPLARY, OR CONSEQUENTIAL DAMAGES (INCLUDING, BUT NOT LIMITED TO, PROCUREMENT OF SUBSTITUTE GOODS OR SERVICES; LOSS OF USE, DATA, OR PROFITS; OR BUSINESS INTERRUPTION) HOWEVER CAUSED AND ON ANY THEORY OF LIABILITY, WHETHER IN CONTRACT, STRICT LIABILITY, OR TORT (INCLUDING NEGLIGENCE OR OTHERWISE) ARISING IN ANY WAY OUT OF THE USE OF THIS SOFTWARE, EVEN IF ADVISED OF THE POSSIBILITY OF SUCH DAMAGE.

---- Part 3: Cambridge Broadband Ltd. copyright notice (BSD) ----

Portions of this code are copyright (c) 2001-2003, Cambridge Broadband Ltd.  
All rights reserved.

Redistribution and use in source and binary forms, with or without modification, are permitted provided that the following conditions are met:

- \* Redistributions of source code must retain the above copyright notice, this list of conditions and the following disclaimer.

- \* Redistributions in binary form must reproduce the above copyright notice, this list of conditions and the following disclaimer in the documentation and/or other materials provided with the distribution.
- \* The name of Cambridge Broadband Ltd. may not be used to endorse or promote products derived from this software without specific prior written permission.

THIS SOFTWARE IS PROVIDED BY THE COPYRIGHT HOLDER ``AS IS" AND ANY EXPRESS OR IMPLIED WARRANTIES, INCLUDING, BUT NOT LIMITED TO, THE IMPLIED WARRANTIES OF MERCHANTABILITY AND FITNESS FOR A PARTICULAR PURPOSE ARE DISCLAIMED. IN NO EVENT SHALL THE COPYRIGHT HOLDER BE LIABLE FOR ANY DIRECT, INDIRECT, INCIDENTAL, SPECIAL, EXEMPLARY, OR CONSEQUENTIAL DAMAGES (INCLUDING, BUT NOT LIMITED TO, PROCUREMENT OF SUBSTITUTE GOODS OR SERVICES; LOSS OF USE, DATA, OR PROFITS; OR BUSINESS INTERRUPTION) HOWEVER CAUSED AND ON ANY THEORY OF LIABILITY, WHETHER IN CONTRACT, STRICT LIABILITY, OR TORT (INCLUDING NEGLIGENCE OR OTHERWISE) ARISING IN ANY WAY OUT OF THE USE OF THIS SOFTWARE, EVEN IF ADVISED OF THE POSSIBILITY OF SUCH DAMAGE.

---- Part 4: Sun Microsystems, Inc. copyright notice (BSD) ----

Copyright © 2003 Sun Microsystems, Inc., 4150 Network Circle, Santa Clara, California 95054, U.S.A. All rights reserved.

Use is subject to license terms below.

This distribution may include materials developed by third parties.

Sun, Sun Microsystems, the Sun logo and Solaris are trademarks or registered trademarks of Sun Microsystems, Inc. in the U.S. and other countries.

Redistribution and use in source and binary forms, with or without modification, are permitted provided that the following conditions are met:

- \* Redistributions of source code must retain the above copyright notice,

this list of conditions and the following disclaimer.

- \* Redistributions in binary form must reproduce the above copyright notice, this list of conditions and the following disclaimer in the documentation and/or other materials provided with the distribution.
  
- \* Neither the name of the Sun Microsystems, Inc. nor the names of its contributors may be used to endorse or promote products derived from this software without specific prior written permission.

THIS SOFTWARE IS PROVIDED BY THE COPYRIGHT HOLDERS AND CONTRIBUTORS "AS IS" AND ANY EXPRESS OR IMPLIED WARRANTIES, INCLUDING, BUT NOT LIMITED TO, THE IMPLIED WARRANTIES OF MERCHANTABILITY AND FITNESS FOR A PARTICULAR PURPOSE ARE DISCLAIMED. IN NO EVENT SHALL THE COPYRIGHT HOLDERS OR CONTRIBUTORS BE LIABLE FOR ANY DIRECT, INDIRECT, INCIDENTAL, SPECIAL, EXEMPLARY, OR CONSEQUENTIAL DAMAGES (INCLUDING, BUT NOT LIMITED TO, PROCUREMENT OF SUBSTITUTE GOODS OR SERVICES; LOSS OF USE, DATA, OR PROFITS; OR BUSINESS INTERRUPTION) HOWEVER CAUSED AND ON ANY THEORY OF LIABILITY, WHETHER IN CONTRACT, STRICT LIABILITY, OR TORT (INCLUDING NEGLIGENCE OR OTHERWISE) ARISING IN ANY WAY OUT OF THE USE OF THIS SOFTWARE, EVEN IF ADVISED OF THE POSSIBILITY OF SUCH DAMAGE.

---- Part 5: Sparta, Inc copyright notice (BSD) ----

Copyright (c) 2003-2012, Sparta, Inc  
All rights reserved.

Redistribution and use in source and binary forms, with or without modification, are permitted provided that the following conditions are met:

- \* Redistributions of source code must retain the above copyright notice, this list of conditions and the following disclaimer.
  
- \* Redistributions in binary form must reproduce the above copyright notice, this list of conditions and the following disclaimer in the documentation and/or other materials provided with the distribution.

- \* Neither the name of Sparta, Inc nor the names of its contributors may be used to endorse or promote products derived from this software without specific prior written permission.

THIS SOFTWARE IS PROVIDED BY THE COPYRIGHT HOLDERS AND CONTRIBUTORS ``AS IS" AND ANY EXPRESS OR IMPLIED WARRANTIES, INCLUDING, BUT NOT LIMITED TO, THE IMPLIED WARRANTIES OF MERCHANTABILITY AND FITNESS FOR A PARTICULAR PURPOSE ARE DISCLAIMED. IN NO EVENT SHALL THE COPYRIGHT HOLDERS OR CONTRIBUTORS BE LIABLE FOR ANY DIRECT, INDIRECT, INCIDENTAL, SPECIAL, EXEMPLARY, OR CONSEQUENTIAL DAMAGES (INCLUDING, BUT NOT LIMITED TO, PROCUREMENT OF SUBSTITUTE GOODS OR SERVICES; LOSS OF USE, DATA, OR PROFITS; OR BUSINESS INTERRUPTION) HOWEVER CAUSED AND ON ANY THEORY OF LIABILITY, WHETHER IN CONTRACT, STRICT LIABILITY, OR TORT (INCLUDING NEGLIGENCE OR OTHERWISE) ARISING IN ANY WAY OUT OF THE USE OF THIS SOFTWARE, EVEN IF ADVISED OF THE POSSIBILITY OF SUCH DAMAGE.

---- Part 6: Cisco/BUPTNIC copyright notice (BSD) ----

Copyright (c) 2004, Cisco, Inc and Information Network  
Center of Beijing University of Posts and Telecommunications.  
All rights reserved.

Redistribution and use in source and binary forms, with or without modification, are permitted provided that the following conditions are met:

- \* Redistributions of source code must retain the above copyright notice, this list of conditions and the following disclaimer.
- \* Redistributions in binary form must reproduce the above copyright notice, this list of conditions and the following disclaimer in the documentation and/or other materials provided with the distribution.
- \* Neither the name of Cisco, Inc, Beijing University of Posts and Telecommunications, nor the names of their contributors may be used to endorse or promote products derived from this software without specific prior written permission.

THIS SOFTWARE IS PROVIDED BY THE COPYRIGHT HOLDERS AND CONTRIBUTORS ``AS

IS" AND ANY EXPRESS OR IMPLIED WARRANTIES, INCLUDING, BUT NOT LIMITED TO, THE IMPLIED WARRANTIES OF MERCHANTABILITY AND FITNESS FOR A PARTICULAR PURPOSE ARE DISCLAIMED. IN NO EVENT SHALL THE COPYRIGHT HOLDERS OR CONTRIBUTORS BE LIABLE FOR ANY DIRECT, INDIRECT, INCIDENTAL, SPECIAL, EXEMPLARY, OR CONSEQUENTIAL DAMAGES (INCLUDING, BUT NOT LIMITED TO, PROCUREMENT OF SUBSTITUTE GOODS OR SERVICES; LOSS OF USE, DATA, OR PROFITS; OR BUSINESS INTERRUPTION) HOWEVER CAUSED AND ON ANY THEORY OF LIABILITY, WHETHER IN CONTRACT, STRICT LIABILITY, OR TORT (INCLUDING NEGLIGENCE OR OTHERWISE) ARISING IN ANY WAY OUT OF THE USE OF THIS SOFTWARE, EVEN IF ADVISED OF THE POSSIBILITY OF SUCH DAMAGE.

---- Part 7: Fabasoft R&D Software GmbH & Co KG copyright notice (BSD) ----

Copyright (c) Fabasoft R&D Software GmbH & Co KG, 2003

oss@fabasoft.com

Author: Bernhard Penz <bernhard.penz@fabasoft.com>

Redistribution and use in source and binary forms, with or without modification, are permitted provided that the following conditions are met:

- \* Redistributions of source code must retain the above copyright notice, this list of conditions and the following disclaimer.
- \* Redistributions in binary form must reproduce the above copyright notice, this list of conditions and the following disclaimer in the documentation and/or other materials provided with the distribution.
- \* The name of Fabasoft R&D Software GmbH & Co KG or any of its subsidiaries, brand or product names may not be used to endorse or promote products derived from this software without specific prior written permission.

THIS SOFTWARE IS PROVIDED BY THE COPYRIGHT HOLDER ``AS IS" AND ANY EXPRESS OR IMPLIED WARRANTIES, INCLUDING, BUT NOT LIMITED TO, THE IMPLIED WARRANTIES OF MERCHANTABILITY AND FITNESS FOR A PARTICULAR PURPOSE ARE DISCLAIMED. IN NO EVENT SHALL THE COPYRIGHT HOLDER BE LIABLE FOR ANY DIRECT, INDIRECT, INCIDENTAL, SPECIAL, EXEMPLARY, OR CONSEQUENTIAL DAMAGES (INCLUDING, BUT NOT LIMITED TO, PROCUREMENT OF SUBSTITUTE GOODS OR SERVICES; LOSS OF USE, DATA, OR PROFITS; OR

BUSINESS INTERRUPTION) HOWEVER CAUSED AND ON ANY THEORY OF LIABILITY, WHETHER IN CONTRACT, STRICT LIABILITY, OR TORT (INCLUDING NEGLIGENCE OR OTHERWISE) ARISING IN ANY WAY OUT OF THE USE OF THIS SOFTWARE, EVEN IF ADVISED OF THE POSSIBILITY OF SUCH DAMAGE.

---- Part 8: Apple Inc. copyright notice (BSD) ----

Copyright (c) 2007 Apple Inc. All rights reserved.

Redistribution and use in source and binary forms, with or without modification, are permitted provided that the following conditions are met:

1. Redistributions of source code must retain the above copyright notice, this list of conditions and the following disclaimer.
2. Redistributions in binary form must reproduce the above copyright notice, this list of conditions and the following disclaimer in the documentation and/or other materials provided with the distribution.
3. Neither the name of Apple Inc. ("Apple") nor the names of its contributors may be used to endorse or promote products derived from this software without specific prior written permission.

THIS SOFTWARE IS PROVIDED BY APPLE AND ITS CONTRIBUTORS "AS IS" AND ANY EXPRESS OR IMPLIED WARRANTIES, INCLUDING, BUT NOT LIMITED TO, THE IMPLIED WARRANTIES OF MERCHANTABILITY AND FITNESS FOR A PARTICULAR PURPOSE ARE DISCLAIMED. IN NO EVENT SHALL APPLE OR ITS CONTRIBUTORS BE LIABLE FOR ANY DIRECT, INDIRECT, INCIDENTAL, SPECIAL, EXEMPLARY, OR CONSEQUENTIAL DAMAGES (INCLUDING, BUT NOT LIMITED TO, PROCUREMENT OF SUBSTITUTE GOODS OR SERVICES; LOSS OF USE, DATA, OR PROFITS; OR BUSINESS INTERRUPTION) HOWEVER CAUSED AND ON ANY THEORY OF LIABILITY, WHETHER IN CONTRACT, STRICT LIABILITY, OR TORT (INCLUDING NEGLIGENCE OR OTHERWISE) ARISING IN ANY WAY OUT OF THE USE OF THIS SOFTWARE, EVEN IF ADVISED OF THE POSSIBILITY OF SUCH DAMAGE.

---- Part 9: ScienceLogic, LLC copyright notice (BSD) ----



Copyright (c) 2009, ScienceLogic, LLC

All rights reserved.

Redistribution and use in source and binary forms, with or without modification, are permitted provided that the following conditions are met:

- \* Redistributions of source code must retain the above copyright notice, this list of conditions and the following disclaimer.
- \* Redistributions in binary form must reproduce the above copyright notice, this list of conditions and the following disclaimer in the documentation and/or other materials provided with the distribution.
- \* Neither the name of ScienceLogic, LLC nor the names of its contributors may be used to endorse or promote products derived from this software without specific prior written permission.

THIS SOFTWARE IS PROVIDED BY THE COPYRIGHT HOLDERS AND CONTRIBUTORS "AS IS" AND ANY EXPRESS OR IMPLIED WARRANTIES, INCLUDING, BUT NOT LIMITED TO, THE IMPLIED WARRANTIES OF MERCHANTABILITY AND FITNESS FOR A PARTICULAR PURPOSE ARE DISCLAIMED. IN NO EVENT SHALL THE COPYRIGHT HOLDERS OR CONTRIBUTORS BE LIABLE FOR ANY DIRECT, INDIRECT, INCIDENTAL, SPECIAL, EXEMPLARY, OR CONSEQUENTIAL DAMAGES (INCLUDING, BUT NOT LIMITED TO, PROCUREMENT OF SUBSTITUTE GOODS OR SERVICES; LOSS OF USE, DATA, OR PROFITS; OR BUSINESS INTERRUPTION) HOWEVER CAUSED AND ON ANY THEORY OF LIABILITY, WHETHER IN CONTRACT, STRICT LIABILITY, OR TORT (INCLUDING NEGLIGENCE OR OTHERWISE) ARISING IN ANY WAY OUT OF THE USE OF THIS SOFTWARE, EVEN IF ADVISED OF THE POSSIBILITY OF SUCH DAMAGE.

## OpenSSL

### OpenSSL License

-----

/\* =====

\* Copyright (c) 1998-2011 The OpenSSL Project. All rights reserved.

\*

\* Redistribution and use in source and binary forms, with or without

\* modification, are permitted provided that the following conditions

\* are met:

\*

\* 1. Redistributions of source code must retain the above copyright

\* notice, this list of conditions and the following disclaimer.

\*

\* 2. Redistributions in binary form must reproduce the above copyright

\* notice, this list of conditions and the following disclaimer in

\* the documentation and/or other materials provided with the

\* distribution.

\*

\* 3. All advertising materials mentioning features or use of this

\* software must display the following acknowledgment:

\* "This product includes software developed by the OpenSSL Project

\* for use in the OpenSSL Toolkit. (<http://www.openssl.org/>)"

\*

\* 4. The names "OpenSSL Toolkit" and "OpenSSL Project" must not be used to

\* endorse or promote products derived from this software without

\* prior written permission. For written permission, please contact

\* [openssl-core@openssl.org](mailto:openssl-core@openssl.org).

\*

\* 5. Products derived from this software may not be called "OpenSSL"

\* nor may "OpenSSL" appear in their names without prior written

\* permission of the OpenSSL Project.

\*

\* 6. Redistributions of any form whatsoever must retain the following

\* acknowledgment:

\* "This product includes software developed by the OpenSSL Project

\* for use in the OpenSSL Toolkit (<http://www.openssl.org/>)"

\*  
\* THIS SOFTWARE IS PROVIDED BY THE OpenSSL PROJECT ``AS IS" AND ANY  
\* EXPRESSED OR IMPLIED WARRANTIES, INCLUDING, BUT NOT LIMITED TO, THE  
\* IMPLIED WARRANTIES OF MERCHANTABILITY AND FITNESS FOR A PARTICULAR  
\* PURPOSE ARE DISCLAIMED. IN NO EVENT SHALL THE OpenSSL PROJECT OR  
\* ITS CONTRIBUTORS BE LIABLE FOR ANY DIRECT, INDIRECT, INCIDENTAL,  
\* SPECIAL, EXEMPLARY, OR CONSEQUENTIAL DAMAGES (INCLUDING, BUT  
\* NOT LIMITED TO, PROCUREMENT OF SUBSTITUTE GOODS OR SERVICES;  
\* LOSS OF USE, DATA, OR PROFITS; OR BUSINESS INTERRUPTION)  
\* HOWEVER CAUSED AND ON ANY THEORY OF LIABILITY, WHETHER IN CONTRACT,  
\* STRICT LIABILITY, OR TORT (INCLUDING NEGLIGENCE OR OTHERWISE)  
\* ARISING IN ANY WAY OUT OF THE USE OF THIS SOFTWARE, EVEN IF ADVISED  
\* OF THE POSSIBILITY OF SUCH DAMAGE.

\* =====

\*  
\* This product includes cryptographic software written by Eric Young  
\* (eay@cryptsoft.com). This product includes software written by Tim  
\* Hudson (tjh@cryptsoft.com).

\*  
\*/

Original SSLeay License

-----

/\* Copyright (C) 1995-1998 Eric Young (eay@cryptsoft.com)  
\* All rights reserved.  
\*  
\* This package is an SSL implementation written  
\* by Eric Young (eay@cryptsoft.com).  
\* The implementation was written so as to conform with Netscapes SSL.  
\*  
\* This library is free for commercial and non-commercial use as long as  
\* the following conditions are aheared to. The following conditions  
\* apply to all code found in this distribution, be it the RC4, RSA,  
\* lhash, DES, etc., code; not just the SSL code. The SSL documentation  
\* included with this distribution is covered by the same copyright terms  
\* except that the holder is Tim Hudson (tjh@cryptsoft.com).  
\*

\* Copyright remains Eric Young's, and as such any Copyright notices in  
 \* the code are not to be removed.

\* If this package is used in a product, Eric Young should be given attribution  
 \* as the author of the parts of the library used.

\* This can be in the form of a textual message at program startup or  
 \* in documentation (online or textual) provided with the package.  
 \*

\* Redistribution and use in source and binary forms, with or without  
 \* modification, are permitted provided that the following conditions  
 \* are met:

\* 1. Redistributions of source code must retain the copyright  
 \* notice, this list of conditions and the following disclaimer.

\* 2. Redistributions in binary form must reproduce the above copyright  
 \* notice, this list of conditions and the following disclaimer in the  
 \* documentation and/or other materials provided with the distribution.

\* 3. All advertising materials mentioning features or use of this software  
 \* must display the following acknowledgement:  
 \* "This product includes cryptographic software written by  
 \* Eric Young (eay@cryptsoft.com)"  
 \* The word 'cryptographic' can be left out if the routines from the library  
 \* being used are not cryptographic related :-).

\* 4. If you include any Windows specific code (or a derivative thereof) from  
 \* the apps directory (application code) you must include an acknowledgement:  
 \* "This product includes software written by Tim Hudson (tjh@cryptsoft.com)"  
 \*

\* THIS SOFTWARE IS PROVIDED BY ERIC YOUNG ``AS IS" AND  
 \* ANY EXPRESS OR IMPLIED WARRANTIES, INCLUDING, BUT NOT LIMITED TO, THE  
 \* IMPLIED WARRANTIES OF MERCHANTABILITY AND FITNESS FOR A PARTICULAR PURPOSE  
 \* ARE DISCLAIMED. IN NO EVENT SHALL THE AUTHOR OR CONTRIBUTORS BE LIABLE  
 \* FOR ANY DIRECT, INDIRECT, INCIDENTAL, SPECIAL, EXEMPLARY, OR CONSEQUENTIAL  
 \* DAMAGES (INCLUDING, BUT NOT LIMITED TO, PROCUREMENT OF SUBSTITUTE GOODS  
 \* OR SERVICES; LOSS OF USE, DATA, OR PROFITS; OR BUSINESS INTERRUPTION)  
 \* HOWEVER CAUSED AND ON ANY THEORY OF LIABILITY, WHETHER IN CONTRACT, STRICT  
 \* LIABILITY, OR TORT (INCLUDING NEGLIGENCE OR OTHERWISE) ARISING IN ANY WAY  
 \* OUT OF THE USE OF THIS SOFTWARE, EVEN IF ADVISED OF THE POSSIBILITY OF  
 \* SUCH DAMAGE.  
 \*

\* The licence and distribution terms for any publically available version or

\* derivative of this code cannot be changed. i.e. this code cannot simply be  
\* copied and put under another distribution licence  
\* [including the GNU Public Licence.]  
\*/