

PB50 | PB51

Mobile Printer



User's Guide

Intermec Technologies Corporation

Worldwide Headquarters

6001 36th Ave.W.

Everett, WA 98203

U.S.A.

www.intermec.com

The information contained herein is provided solely for the purpose of allowing customers to operate and service Intermec-manufactured equipment and is not to be released, reproduced, or used for any other purpose without written permission of Intermec Technologies Corporation.

Information and specifications contained in this document are subject to change without prior notice and do not represent a commitment on the part of Intermec Technologies Corporation.

© 2007 - 2010 by Intermec Technologies Corporation. All rights reserved.

The word Intermec, the Intermec logo, Norand, ArciTech, Beverage Routebook, CrossBar, dcBrowser, Duratherm, EasyADC, EasyCoder, EasySet, Fingerprint, i-gistics, INCA (under license), Intellitag, Intellitag Gen2, JANUS, LabelShop, MobileLAN, Picolink, Ready-to-Work, RoutePower, Sabre, ScanPlus, ShopScan, Smart Mobile Computing, SmartSystems, TE 2000, Trakker Antares, and Vista Powered are either trademarks or registered trademarks of Intermec Technologies Corporation.

There are U.S. and foreign patents as well as U.S. and foreign patents pending.

Wi-Fi is a registered certification mark of the Wi-Fi Alliance.

Bluetooth is a trademark of Bluetooth SIG, Inc., U.S.A.

Document Change Record

This page records changes to this document. The document was originally released as Revision 001.

Version Number	Date	Description of Change
004	1/2010	<ul style="list-style-type: none">• Updated procedures for upgrading printer firmware and cleaning the printer.
003	5/2009	<ul style="list-style-type: none">• Addition of information describing the PB51 printer.• Addition of changes to the media adjust in the PB50 printer.
002	11/2008	<p>These changes were made for the current release:</p> <ul style="list-style-type: none">• Support for the ESC/P programming language.• Addition of a radioless PB50 printer.• Change to the Ready-to-Work indicator behavior.• Addition of linerless media support.• New icons for Bluetooth radio and addition of printhead lifted error message.• Addition of power management options Sleep Timer and Standby Timer.

Contents

Before You Begin.....	ix
Safety Information.....	ix
Global Services and Support.....	ix
Warranty Information.....	ix
Web Support.....	ix
Telephone Support.....	x
Service Location Support.....	x
Who Should Read This Manual.....	x
Related Documents.....	xi

1 Using the Mobile Printer..... 1

Introducing the Mobile Printer.....	2
What's New?.....	2
Features of the Printer.....	3
Identifying the Parts of the Printer.....	3
Understanding the Control Panel.....	4
Understanding the Printer Language.....	6
Understanding the Printer Sounds.....	7
Using the Batteries.....	7
Installing the Battery.....	8
Charging the Batteries.....	8
Understanding the Battery Icons.....	9
Managing Power on the Mobile Printer.....	10
Extending Battery Life.....	11
Loading Media.....	11
Printing on Floodcoated Media.....	16
Understanding the Display Modes.....	17
Understanding Ready Mode.....	17
Understanding Information Mode.....	17
Understanding Pause Mode.....	18
Understanding Setup Mode.....	18
Understanding Error Mode.....	19
Understanding Test Mode.....	20
Printing a Test Page.....	22

2	Configuring the Mobile Printer	25
	Connecting the Printer to Your PC	26
	Connecting the Printer Through the USB Interface	26
	Connecting the Printer Through the Serial Port	27
	Connecting the Printer to Your Network	29
	Setting Up Bluetooth Communications	29
	Setting Up 802.11 Radio Communications	30
	Configuring Wireless Printing Using IPL	33
	Configuring Wireless Printing Using Fingerprint	36
	Configuring the Printer Settings	38
	Changing Configuration Settings From the Display	38
	Changing Configuration Settings From PrintSet	40
	Changing Configuration Settings Using the Command Line	40
	Changing Configuration Settings From the Printer Home Page	41
	Changing Configuration Settings From the SmartSystems Console ..	42
	Upgrading the Firmware	43
	Upgrading the Printer Firmware Using PrintSet	43
	Upgrading the Printer Firmware Using the Printer Home Page	44
	Upgrading Printer Firmware Using SmartSystems Foundation	47
	Upgrading the Printer Firmware Using a Communications Program	48
	Downloading Fonts and Graphics	51
3	Troubleshooting and Maintaining the Mobile Printer	53
	Troubleshooting the Mobile Printer	54
	Contacting Product Support	54
	Understanding Error Messages	54
	Troubleshooting Printer Problems and Finding Solutions	56
	Troubleshooting Communication Problems	58
	Using the Line Analyzer in Fingerprint	58
	Using Dump Mode in IPL	59
	Resetting the Mobile Printer	60
	Cleaning the Printer	60
	Cleaning the Printhead	61
	Cleaning the Platen Roller	62
	Cleaning the Printer Exterior	62

Cleaning the Printer Media Compartment 63

A Specifications 65

Specifications..... 66

Interfaces..... 70

 RS-232 Serial Interface 70

 USB Interface..... 71

Accessories for the Mobile Printer 72

B IPL and Fingerprint Setup Menus..... 75

IPL Setup Menu 76

Fingerprint Setup Menu..... 77

Contents

Before You Begin

This section provides you with safety information, technical support information, and sources for additional product information.

Safety Information

Your safety is extremely important. Read and follow all warnings and cautions in this document before handling and operating Intermec equipment. You can be seriously injured, and equipment and data can be damaged if you do not follow the safety warnings and cautions.

This section explains how to identify and understand warnings, cautions, and notes that are in this document.



A warning alerts you of an operating procedure, practice, condition, or statement that must be strictly observed to avoid death or serious injury to the persons working on the equipment.



A caution alerts you to an operating procedure, practice, condition, or statement that must be strictly observed to prevent equipment damage or destruction, or corruption or loss of data.



Note: Notes either provide extra information about a topic or contain special instructions for handling a particular condition or set of circumstances.

Global Services and Support

Warranty Information

To understand the warranty for your Intermec product, visit the Intermec web site at www.intermec.com and click **Support > Returns and Repairs > Warranty**.

Web Support

Visit the Intermec web site at www.intermec.com to download our current manuals (in PDF). To order printed versions of the Intermec manuals, contact your local Intermec representative or distributor.

Visit the Intermecc technical knowledge base (Knowledge Central) at www.intermec.com and click **Support > Knowledge Central** to review technical information or to request technical support for your Intermecc product.

Telephone Support

In the U.S.A. and Canada, call **1-800-755-5505**.

Outside the U.S.A. and Canada, contact your local Intermecc representative. To search for your local representative, from the Intermecc web site, click **About Us > Contact Us**.

Service Location Support

For the most current listing of service locations, go to www.intermec.com and click **Support > Returns and Repairs > Repair Locations**.

For technical support in South Korea, use the after service locations listed below:

AWOO Systems

102-1304 SK Ventium

522 Dangjung-dong

Gunpo-si, Gyeonggi-do Korea, South 435-776

Contact: Mr. Sinbum Kang

Telephone: +82-31-436-1191

E-mail: mjyun@awoo.co.kr

IN Information System PTD LTD

6th Floor

Daegu Venture Center Bldg 95

Shinchun 3 Dong

Donggu, Daegu City, Korea

E-mail: jmyou@idif.co.kr or korlim@gw.idif.co.kr

Who Should Read This Manual

This document is for the person who is responsible for installing, configuring, and maintaining the PB50 or PB51 mobile printer.

This document provides you with information about the features of the mobile printer, and how to install, configure, operate, maintain, and troubleshoot it.

Before you work with the mobile printer, you should be familiar with your network and general networking terms, such as IP address.

Related Documents

This table contains a list of related Intermec documents and their part numbers.

Document Title
<i>Intermec Fingerprint Command Reference Manual</i>
<i>Intermec Fingerprint Developer's Guide</i>
<i>Intermec Printer Language (IPL) Developer's Guide</i>
<i>Intermec Printer Language (IPL) Command Reference Manual</i>
<i>ESC/P Programmer's Reference Manual</i>

The Intermec web site at www.intermec.com contains our documents (as PDF files) that you can download for free.

To download documents

- 1 Visit the Intermec web site at www.intermec.com.
- 2 Click the **Products** tab.
- 3 Use the **Products** menu, navigate to your product page. For example, to find the CN3 computer product page, click **Computers > Handheld Computers > CN3**.
- 4 Click the **Manuals** tab.

Before You Begin

1

Using the Mobile Printer

Use this chapter to familiarize yourself with your mobile printer. In this chapter you will find these sections:

- **Introducing the Mobile Printer**
- **Features of the Printer**
- **Using the Batteries**
- **Loading Media**
- **Printing on Floodcoated Media**
- **Understanding the Display Modes**
- **Printing a Test Page**

Introducing the Mobile Printer

The PB50, PB50C, and PB51 are rugged direct thermal label and receipt printers designed for use with Intermec mobile computers as well as the SF51 and SR61 scanners. The PB50 is intended to be used primarily for label printing, and the PB51 is intended to be used primarily for receipt printing.

Throughout this manual, all models of the printer are referred to as printer unless the information is specific to one model.

The printer provides:

- print resolution of 203 dpi.
- print speeds of up to 100 mm per second (4 ips).
- 802.11 radio, Bluetooth radio, or no radio options.



Note: Unless otherwise noted, this manual uses the term “printer” to refer to both the PB50 and PB51 printers.

What’s New?

This version of the printer manual contains these changes:

- Updated information for upgrading printer firmware.
- Updated information for configuring the printer.
- Updated information for cleaning the printer.

Features of the Printer

Use this section to understand how to use the printer. This section contains information about:

- parts of the printer.
- control panel.
- printer language.
- printer sounds.

Identifying the Parts of the Printer

Use the illustration to familiarize yourself with some of the features of the printer.

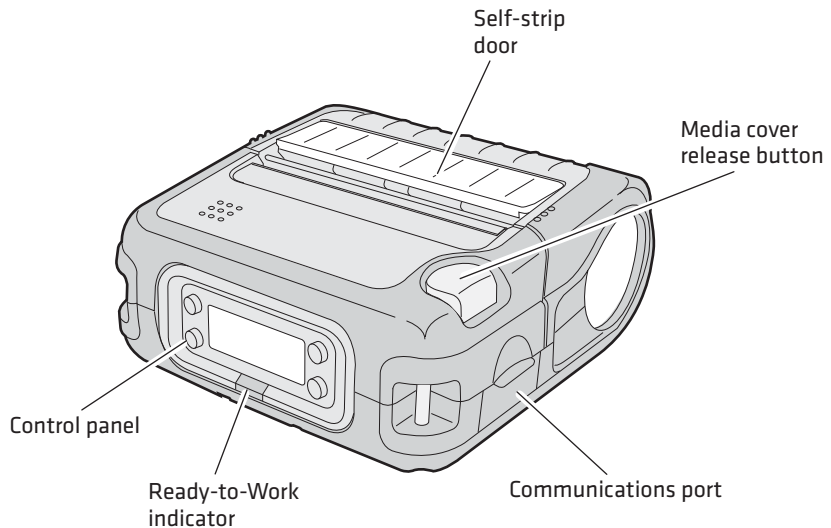

PB50 and PB51 Mobile Printer: This illustration shows the important features of the printer. A weather-resistant flap protects the communications port and the external power connector.



Note: The PB50 has a self-strip door but the PB51 does not.



Understanding the Control Panel

The printer control panel contains four buttons, a liquid crystal display (LCD), and one LED indicator. Use the four buttons to navigate the menu system and perform functions on the printer. See the following tables to understand the buttons, the menu system, and what the LED means.





Printer Control Panel: Use this illustration to familiarize yourself with the buttons and lights on the printer.

Understanding How to Use the Printer Buttons











Button Name	Button	Function
Feed		<p>Press to advance label or receipt paper. The amount of media that feeds is dependent on the type of media you are using. It will advance by 5 mm (0.2 inch), feed out an entire label, or feed a configured length of media based on your media and settings.</p> <p>If you hold the button down for longer than two seconds, the printer performs a testfeed and calibrates the media.</p> <p>If the printer is printing, pressing this button causes the printer to pause. Press the button again to resume printing.</p>
Setup		<p>Press to display the Setup menu. With ESC/P firmware, press and hold to cancel printing.</p>

Understanding How to Use the Printer Buttons (continued)

Button Name	Button	Function
Standby (Power)		Press to put the printer in Standby mode. In Standby mode, power to the radio, the display, and the backlight are turned off. Press to turn the printer back on and put in Ready mode.
Info		Press to display a summary of network connection information and error conditions. Each setting in the summary information displays on the screen for five seconds. In Fingerprint and IPL, press this button in Pause mode to cancel the print job. The info button is not functional with ESC/P.

All of the buttons can act as “soft keys,” which means that the function of each button depends on the state of the printer. A small icon appears in the screen next to the button to indicate the function it performs

Understanding the Soft Keys

Button	Soft Keys	Description
		Moves through the settings at the same level in the menu system.
		Exit Setup mode and return to Ready mode.
		• Moves up one level in the menu system. This soft key appears in Setup mode.
		• Increases the value of a number when editing settings such as an IP address. This soft key appears in Setup mode.
		• Pauses the printing job. This icon appears only when you are printing.
	OK	• Moves down one level in the menu system and saves changes to a setting.
		• Exits a printing job or exits Information mode.

There is only one LED on the printer: the Ready-to-Work™ indicator.

Understanding the Ready-to-Work Indicator

Indicator State	Description
Off	When the light is off, it can mean one of several conditions: <ul style="list-style-type: none">• The printer is in Standby mode.• The printer is in Info mode.• The printer is in Setup mode.
On	The printer is powered on and operating.
Blinking	A blinking light can mean one of several conditions: <ul style="list-style-type: none">• The printer is out of paper.• The media cover is open.• There is a printer error that requires you to perform an action. For a list of possible problems, see “Troubleshooting the Mobile Printer” on page 54.

Understanding the Printer Language

Depending on the configuration you ordered, your printer comes with Intermec Printer Language (IPL), Fingerprint. This manual contains information for using both printer language.

The current firmware type and version display on the printer screen when the printer is in Ready mode.

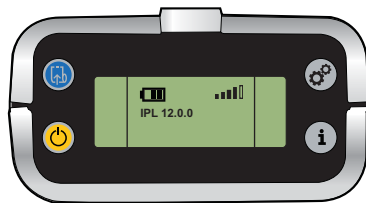

The Screen of a PB50 and PB51 Running IPL Firmware

Understanding the Printer Sounds

The printer plays sounds in response to several actions that you can take with it. Use the following table to understand when the sounds occur and what they mean.

Understanding the Printer Sounds

Sound	Occurs When:
Power	<ul style="list-style-type: none"> You supply power (battery or AC adapter) to the printer. The printer starts charging the battery.
Hardware	You open the media door, close the media door, or insert a cable.
Button	You press any of the printer buttons.
Error	<ul style="list-style-type: none"> The printer cannot feed paper or print a job because of a hardware issue such as the media door open, a paper jam, or there is no media. An error occurs such as a paper jam or a print error.

Using the Batteries

The printer uses a rechargeable 2200 mAh lithium-ion battery (Model AB13) for power. You must fully charge the battery before you can use the printer. A fully charged battery can last up to one week without needing to be recharged when the printer is in Standby mode.



Caution

Use Intermec Model AB13 battery only. Use of another battery may present a risk of fire or explosion.



Caution

The Model AB13 battery may present a fire or chemical burn hazard if mistreated. Do not disassemble, heat above 100°C (212°F), or incinerate.

Dispose of used batteries promptly. Keep away from children.

Installing the Battery

Make sure you fully charge the battery before you use your printer. You can charge the battery before or after you install them into the printer.

To install the battery

- 1 Lay the printer upside down on a flat surface.
- 2 Insert the battery with the tab facing away from the front control panel.

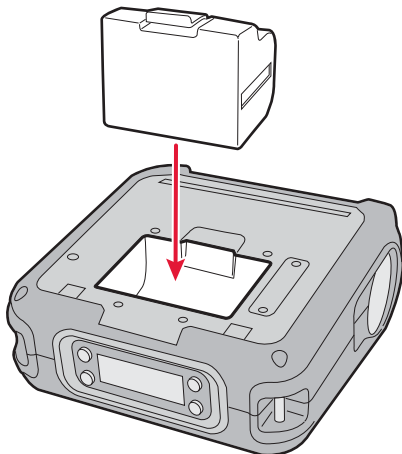

- 3 Insert the edge of the battery under the lip of the printer and then push down until you hear the battery latch click.

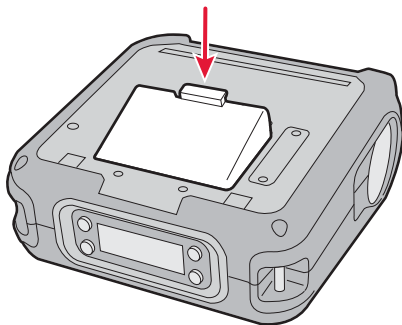

Charging the Batteries

There are two ways to charge the printer battery:

- Connect AC power to the printer and charge the battery while it is in the printer.
- Charge the battery in the AC18 4-bay battery charger.

For information on charging your battery in the 4-bay battery charger, see the [AC18 4-Bay Battery Charger Instructions](#).

It takes approximately 6 hours to charge the battery while it is installed in the printer. To charge the battery inside the printer, you need:

- an Intermec 12 VDC power supply (Model AE19).
- an AC power cord.





To charge the battery inside the printer

- 1 Install the battery in the printer. For help, see the previous section, [“Installing the Battery” on page 8](#).
- 2 Connect the power supply to the DC power connector on the printer.
- 3 Connect one end of the power cord to the power supply and then plug the other end into an AC outlet.

Understanding the Battery Icons

The easiest way to tell the status of your battery is to look at the battery icons on the control panel of the printer.

Battery Icon Status

Icon	Status
	Battery is fully charged.
	Battery has a medium charge. You should be able to work for several more hours before charging or replacing the battery.
	Battery is low. You need to replace the battery soon.
	Battery is critically low. You need to replace the battery now.
	Battery charging error. You may need to replace the battery.

Battery Icon Status (continued)

Icon	Status
	External power connected and there is no battery in the printer.

Managing Power on the Mobile Printer

Use the power options on the printer to manage and conserve battery power. From the Power option in Setup menu, you can set Low Battery, Sleep Timer, and Standby Timer.

Use the Low Battery option to set the battery voltage at which the low battery warning appears. The values for Low Battery range from 12.1 V to 16.8 V in 0.1 V increments. The default setting is 13.5 V.

Use the Sleep Timer option to set the amount of time it takes for the printer to go to “sleep” if it is not printing and you do not have any interaction with it. When the printer goes to “sleep,” it turns off the backlight and it dims the Ready-to-Work indicator. By default, the printer backlight turns off after 20 seconds of no user interaction. You can set Sleep Timer to always off, always on, 5 seconds, 10 seconds, 20 seconds, 30 seconds, or 60 seconds. The backlight turns on when:

- the printer begins printing.
- you press a button.
- you connect the printer to external power.
- you are communicating with or sending data to the printer.



Note: If you have Sleep Timer set to always on, the Standby timer setting will have no effect.

Use the Standby Timer option to turn off power to the radio, the display, and the backlight. The Standby Timer option has the same effect on the printer as pressing the Standby button. When the printer is in Standby mode, both the LCD and the Ready-to-Work indicator are turned off. You can set Standby Timer to 5 mins, 10 mins, 20 mins, 30 mins, 60 mins, or disabled. Press the **Standby** button to turn the printer back on.

Extending Battery Life

Here are some tips for extending the overall life of your battery:

- Never expose the battery to direct sunlight or temperatures over 50°C (122°F).
- Only charge the battery inside the printer using a power supply or in the 4-bay battery charger (Model AC18).
- Do not set the backlight to **always on**. The **always on** setting disables the automatic power saving modes.

Here are some tips for extending the life of your battery between charges:

- Press the **Standby** button to put the printer in Standby mode.
- Remove the battery from the printer if you will not be using it for three days or more.
- Do not operate the printer in extremely cold temperatures. Using the printer in temperatures below freezing reduces the overall battery life.

Remember that any rechargeable battery loses its ability to maintain a charge over time. You can only recharge it a finite number of times before you must replace it.

Loading Media

You can use roll or fanfold receipt media with both the PB50 and PB51 printers. Your printer ships with a small amount of media loaded and a test page printed to verify that the printer works. The PB50 printer supports self-strip printing applications. For information on how to correctly load media for self-strip printing, see **“To load media for self-strip printing (PB50 only)” on page 14**. For information on media specifications, see **“Specifications” on page 66**.

To load media

- 1 Make sure that the printer is in Ready mode.

Chapter 1 – Using the Mobile Printer

- If the printer is off or in Standby mode, press the **Standby** button.
 - If the printer is already on, press the  soft key to return to Ready mode.
- 2** Press down on the blue media cover release button until the cover releases.

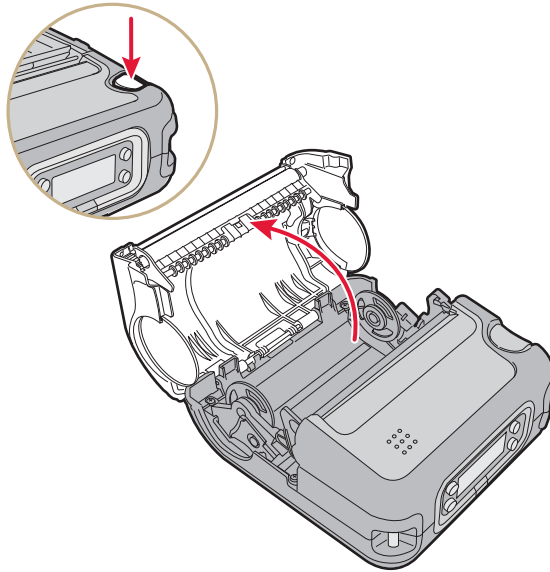

- 3 Slide the two media supports apart.

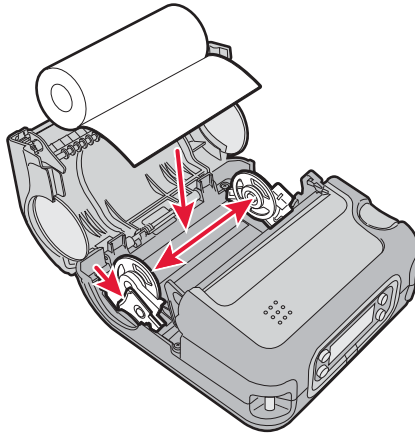

- 4 Insert a roll of media and press the media adjust guide until the roll is held firmly in place. Make sure you load the media clockwise so that it pulls off the core from the bottom of the printer.
- 5 Pull out approximately 8 cm (3 inches) of the media.
- 6 Close the media cover until it latches. The printer emits the hardware sound to tell you that the media door closed correctly.

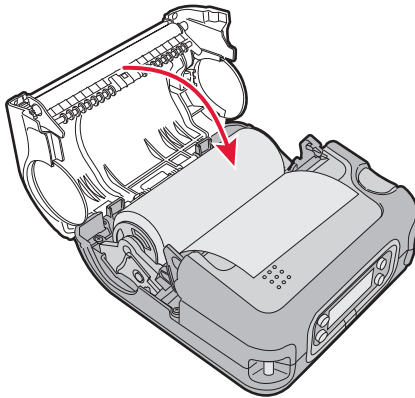

- 7 Press down on the self-strip door to make sure the media cover is completely latched.



Note: The linerless printer does not have a self-strip door. Instead, the self-strip door is molded plastic and part of the media cover.

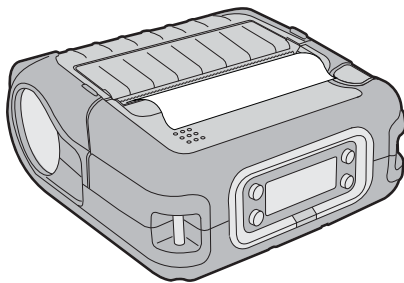

- 8 Press and hold the **Feed** button for more than two seconds to calibrate the media.

To load media for self-strip printing (PB50 only)

- 1 Complete Steps 1 through 3 in the previous procedure.
- 2 Open the self-strip door in the media cover.

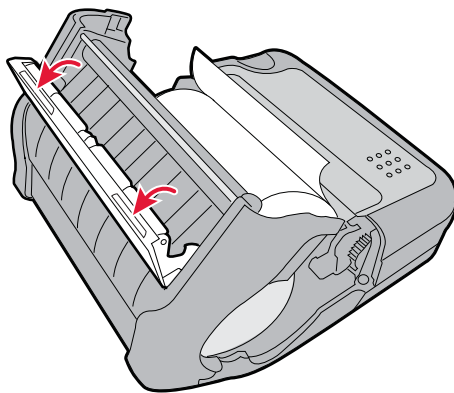

- 3** Feed the label liner over the self-strip bar and out the back of the self-strip door.

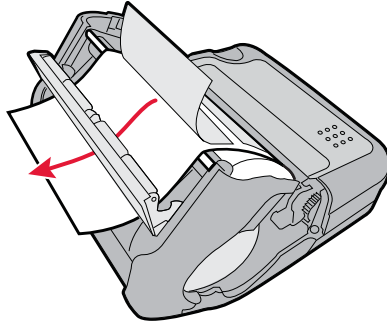

- 4** Remove a label from the roll of media so that you are left with several inches of label liner.
- 5** Close the media cover until it latches and press down on the self-strip door to make sure it locks.

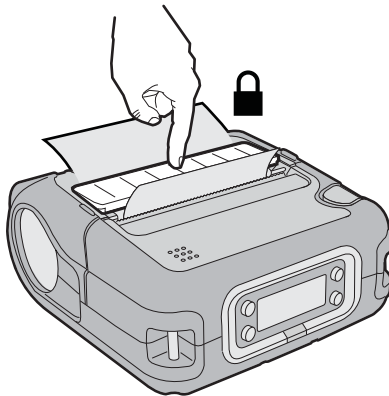

- 6** Pull on the liner to tighten it and ensure a good self strip.
- 7** Press and hold the **Feed** button for more than two seconds to calibrate the media.

Printing on Floodcoated Media

If you are using colored media, also known as floodcoated media, you may need to adjust the settings to enable better printing.

To configure the printer to print on Floodcoated media

- 1 Press the **Setup** button.
- 2 Press **➤** until you reach **Media**.
- 3 Press **OK** to enter the Media menu system.
- 4 Press **➤** until you reach **Advanced**.
- 5 Press **OK** to enter the Advanced menu system.
- 6 Press **➤** until you reach **Thermal Management**.
- 7 Press **OK** to enter the Thermal Management menu system.
- 8 Press **➤** until you reach **Custom TM**.
- 9 Press **OK** to select Custom TM.

To adjust the print speed for floodcoated media

- 1 Press the **Setup** button.
- 2 Press **➤** until you reach **Media**.
- 3 Press **OK** to enter the Media menu system.
- 4 Press **➤** until you reach **Advanced**.
- 5 Press **OK** to enter the Advanced menu system.
- 6 Press **➤** until you reach **Min Speed**.
- 7 Press the **Feed** button to scroll through a list of numbers. Choose a number that is appropriate for the floodcoated media. To see a sensitivity settings for each media type, go to **“Recommended Media Sensitivity, Constant, Factor, and Print Speed” on page 69**.
- 8 Press **OK** to select a number.
- 9 Reboot your printer.

Understanding the Display Modes

The printer has six display modes to help you effectively interact with the printer: Ready, Information, Paused, Setup, Error, and Test. Use the following sections to understand the different printer modes.

Understanding Ready Mode

The printer is in Ready mode when the printer is on and ready to print. The main screen displays the power status, the radio status, and the printer language and version.

To enter ready mode

- If the printer is off or in Standby mode, press the **Standby** button.
- If the printer is already on, press the  soft key to return to Ready mode.



The Printer in Ready Mode

Understanding Information Mode

When the printer is in Information mode, it displays a subset of network information about the printer. If the printer experienced an error, the error message displays first followed by the printer information. Each message displays on the screen for five seconds. After five seconds on the last information screen, the printer exits Information mode.

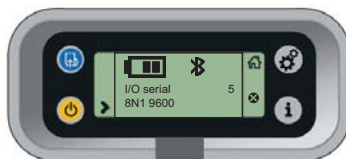

The Printer in Information Mode

To enter Information mode

- Press the **Information** button on the control panel.

Understanding Pause Mode

Use Pause mode to momentarily stop printing or to cancel a current print job. Once you pause the printer, the Pause mode screen appears. Use the **Feed** button to both pause and resume printing.

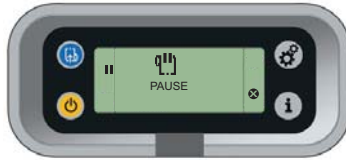

The Printer in Pause Mode

To enter Pause mode

- Press the **Feed** button while the printer is printing.

To resume printing

- Press the **Feed** button (or **||** soft key).

To cancel a print job

- 1 Press the **Feed** button to pause printing.
- 2 Press the Information button (or **⊗** soft key) to cancel the print job.

Understanding Setup Mode

Use Setup mode to change the settings on the printer.



Sample Setup Mode Screen

To enter or exit Setup mode

- Press the **Setup** button.

Once you enter Setup mode, there are two editing modes: normal and enhanced.

Editing Settings in Setup Mode

Editing Mode	To Navigate	To Accept Value
Normal	<ul style="list-style-type: none"> Press ▶ to move among choices. Press ▲ to go up a level in menu system. 	Press OK .
Enhanced	<ul style="list-style-type: none"> Press ▶ to move within the editable fields. When the field blinks, you can edit it. Press + to increase the value of the field. 	Press OK .

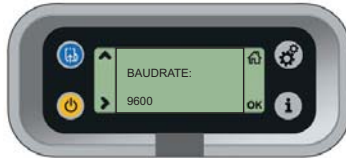

Normal Editing Mode: In normal editing mode, you see an up arrow and a right arrow for making selections.



Enhanced Editing Mode: In enhanced editing mode you have a plus sign and a right arrow to change the value of numeric fields.

Understanding Error Mode

The printer enters Error mode when it detects an error condition such as a low battery or a paper fault. Some error messages appear on the screen immediately when they occur, such as DOOR OPEN. Other error messages do not appear until you press the **Info** button. If there is more than one error at a given time, the errors display in the order that they occurred.



Sample Error Mode Screen

If you encounter an error message, see **“Understanding Error Messages” on page 54** for information on how to fix the problem.

Understanding Test Mode

Use Test mode to verify printer settings, print test labels, restore factory default settings, or enter Dump mode for troubleshooting purposes. Two test modes are available: Test mode and Extended Test mode.

Using Test Mode

Test mode is a simple sequence of events which requires little user interaction. Extended Test mode requires more user interaction and lets you choose which actions you want the printer to perform.

To enter Test mode

- 1** Make sure the printer is in Ready mode and is loaded with media.
- 2** Press the **Feed** and **Standby** buttons at the same time and hold until Select Media appears on the screen and it displays the type of media you are using.
- 3** Release both buttons. The printer performs a test feed (sensor calibration), prints a series of test labels, and then enters Dump mode.

The printer is now in Dump mode and it scans the communication ports. Any characters received on the communication ports are printed.

- 4** Press **Feed** to exit Dump mode.

After you exit Dump mode, the printer returns to Ready mode. For more information on Dump mode, see **“Troubleshooting Communication Problems” on page 58**.

Using Extended Test Mode

Use Extended Test mode to run additional diagnostic tests, including printing specific test labels, entering Dump mode, and resetting to factory defaults.



Sample Extended Test Mode Screen

To enter Extended Test mode

- 1 Make sure that the printer is loaded with media.
- 2 Press the media cover release button to open the media cover.
- 3 Press the **Standby** button to turn the printer off.
- 4 Press **Feed** and **Standby** buttons at the same time until CLOSE PRINTER DOOR appears on the screen.
- 5 Close the media cover. You are now in Extended Test mode.
 - Press **➤** to cycle through the options.
 - Press **OK** to select a test option.
 - Press **⏪** to exit Extended Test mode.

Options in Extended Test Mode

Function	Description
Select Media	This option is almost the same as the process in Test mode, except that the printer performs a slow test feed in Extended Test mode. The slow test feed enables the printer to perform a slow sensor calibration which can help resolve gap or mark detection problems.
Test Labels	This option allows you to print test labels one at a time. Press OK to print the next label.

Options in Extended Test Mode (continued)

Function	Description
Dump Mode	This options enters Dump mode. For more information on Dump mode, see “Troubleshooting Communication Problems” on page 58.
Factory Default	This option restores the factory default settings. Press OK to select this option and then follow the instructions on the screen.
Setup and Exit	This option exits Extended Test mode and puts the printer in Setup mode.
Exit	This option exits Extended Test mode.

Printing a Test Page

After you have loaded media in the printer, you are ready to print a testprint. You can choose from several testprint options for each type of firmware. If you cannot get the testprint information to print, see [“Troubleshooting the Mobile Printer” on page 54.](#)

To print a test page with a printer loaded with IPL

- 1 Press the **Setup** button.
- 2 Press **➤** until you reach **Test/Service**.
- 3 Press **OK** to enter the Test/Service menu system.
- 4 Press **OK** to enter the Testprint Config menu.
- 5 Press **OK** to enter the Config menu.
- 6 Press **➤** to choose a testprint.
- 7 Press **OK** to print the Config testprint of your choice.

To print a test page with a printer loaded with Fingerprint

- 1 Press the **Setup** button.
- 2 Press **➤** until you reach **Print Defs**.
- 3 Press **OK** to enter the Print Defs menu system.
- 4 Press **➤** until you reach **Testprint**.
- 5 Press **OK** to enter the Testprint menu.

- 6** Press **>** to choose a testprint.
- 7** Press **OK** to print the testprint of your choice.

To print a self test with a printer loaded with ESC/P

- 1** Press and hold the **Feed** and **Power** button simultaneously for approximately five seconds.
- 2** Release the **Feed** and **Power** buttons when the printer displays the media you are printing on.
- 3** Press the **Feed** button to exit Dump Mode.

2

Configuring the Mobile Printer

In this chapter you will find these sections:

- **Connecting the Printer to Your PC**
- **Connecting the Printer to Your Network**
- **Configuring the Printer Settings**
- **Upgrading the Firmware**
- **Downloading Fonts and Graphics**

Connecting the Printer to Your PC

You can easily connect to the printer to your PC using one of these ports:

- USB port
- RS-232 serial interface port

Connecting the Printer Through the USB Interface

To connect the printer to a PC through the USB device port, you need to install Intermec InterDriver® software. To make sure you have the latest version of InterDriver, you may want to go to the downloads page for the printer on <http://www.intermec.com/support/downloads/index.aspx>.

The USB cable you need is not included in the shipping box with the printer. To connect the printer to your PC using the USB port, you need:

- a USB cable (P/N 321-611-xxx).

To connect the printer through a USB port

- 1 Open the Interdriver executable.
- 2 The File Download - Security Warning screen appears. Click **Run** to run the executable.
- 3 The **Intermec End User License Agreement** appears. Read the agreement and select the radio button to accept the agreement, and then click **Next**.
- 4 The Installation Directory screen appears. The default installation directory is c:\Intermec\InterDriver7. Click **Next** to use the default directory or specify a different location to install the files.
- 5 The Installation Information screen appears. Clear the **Run Add Print Wizard after unpacking drivers** check box and click **Finish**.

- 6 On the New Hardware Wizard screen, select **Install from a list or specific location** and then click **Next** to continue.



Note: For LPT connections, you must restart your computer for Windows to detect the new hardware. For USB connections, the New Hardware Wizard will launch automatically when the printer is connected and turned on.

- 7 On the Search and Installation Options screen, click **Next**.
- 8 On the Hardware Installation warning screen, click **Continue Anyway**.
- 9 Click **Finish** to exit the New Hardware Wizard. InterDriver files are now installed on your computer.
- 10 Connect the USB cable to the connector on the back of the printer and connect the other end to your PC. You do not need to set up any parameters for USB communications.

Connecting the Printer Through the Serial Port

You can use a serial connection to communicate with your PC and run PrintSet, LabelShop, or InterDriver. You can also use the serial port to send commands directly to the printer through a communications program like HyperTerminal.

The serial communication parameters control the communication between the printer and the PC connected on the serial port, referred to as “uart1:” on the printer. Make sure the serial port settings on the printer match the settings on the connected device. The default serial communication settings on the printer are: 115200 baud rate, 8 data bits, no parity, 1 stop bit, and no flow control.

The serial cable you need is not included in the shipping box with the printer. To connect the printer to your PC using the serial port, you need:

- a serial cable (P/N 075497).

To connect the printer to a PC through the serial port

- 1 Connect the serial cable to the connector on the back of the printer and connect the other end to your PC.
- 2 On your PC, start the communications program.

- 3 If necessary, configure the PC port settings so they match those of your printer.

Bits per second: 115200

Data bits: 8

Parity: None

Stop bits: 1

Flow control: XON_XOFF

- 4 If you are using HyperTerminal
 - a Click the **Settings** tab.
 - b Click **ASCII Setup**. The ASCII Setup window appears.
 - c Check the following check boxes:
 - **Send line ends with line feed**
 - **Echo typed characters locally**
 - **Append line feeds to incoming line ends**
 - Click **OK** to save and exit ASCII Setup.
- 5 Test your connection by typing one of the following commands on your communications program window
 - For IPL, press **Ctrl** and in communications program window simultaneously type:
b, w, c
 - For FingerPrint, type:
FF
and press **Enter**.
 - For ESC/P, press the **ESC** key and type:
EZ {AHEAD:10}

The printer responds by feeding a small amount of media.

Connecting the Printer to Your Network

The printer must establish communications with a host that will send the data for the printer to print. The printer provides four ways to communicate with a host:

- Bluetooth radio communications
- 802.11 b/g radio communications

Setting Up Bluetooth Communications

Your mobile printer can contain a Bluetooth radio that allows wireless communications with a remote device from distances up to 100 meters (approximately 328 feet) depending on the Bluetooth range capabilities of the remote device, environmental conditions, and obstructions. For the Bluetooth-enabled devices to exchange data, both devices must establish a connection. Bluetooth software is always running in the background.

A printer cannot initiate a Bluetooth connection. One of the devices, such as a CK31, CK61, 700 series, CN2B, or CN3 mobile computer, must request a connection with the printer. The printer then accepts or rejects the connection. Use Intermec Settings on the mobile computer to enable the Bluetooth settings on the printer.

If the printer has a Bluetooth connection, it can also connect to Bluetooth scanners, such as the SF51 and the SR61 Cordless scanners. You can create the bar code labels you need to connect the printer to a Bluetooth scanner using EasySet software. If you are going to create the bar code labels using EasySet, you will need to know the Bluetooth Device Address and the PIN of the printer. You can download a free version of EasySet from the Intermec web site at www.intermec.com.

Each printer equipped with a Bluetooth radio has a unique Bluetooth Device Address (BDA) loaded into its module when manufactured. You can find the BDA on the certification label located on the bottom of the printer.

To set up Bluetooth communications with a mobile computer



- Follow the procedure to discover and connect to Bluetooth devices in your mobile computer user’s manual.



Note: For maximum security, you need to configure a Bluetooth passcode for your mobile printer. The default passcode is “1234.”

To set up Bluetooth communications with a scanner

- 1 Download and install EasySet.
- 2 Create the following bar code labels using EasySet:
 - Administrator reset factory defaults
 - Bluetooth parameters - security - not active
 - Bluetooth parameters - connect/disconnect - compose BT address
 - Bluetooth parameters - security - compose PIN:
- 3 Scan the bar code labels with the Bluetooth scanner.

Icon	Description
	The Bluetooth radio is on and the printer is not connected to a serial cable.
	The Bluetooth radio is turned off. The Bluetooth radio turns off when you connect a serial cable.

Setting Up 802.11 Radio Communications

The printer can have an internal 802.11 b/g radio to transfer and receive data using wireless communications. This manual assumes that you have already set up your wireless communications network including your access points. The following procedures include information on setting up wireless security for both IPL and Fingerprint versions of the printer.

The printer supports these authentication modes: none, WEP, WPA Personal and Enterprise mode (802.1x authentication), WPA2 Personal and Enterprise mode (802.1x authentication).



Note: WPA and WPA2 Enterprise mode currently support PEAP, TTLS, and LEAP. For LEAP authentication, the printer supports Open EAP, but does not support Network EAP.

To set up the printer to work in your wireless network, you need these items:

- Serial cable (P/N 075497-001)
- Host PC running Windows or Linux
- A communications program such as HyperTerminal.

To set up the printer for wireless communications

- 1 Connect the 8-pin circular DIN connector to the serial port on the printer.
- 2 Connect the other end of the serial cable to a serial port on the back of your PC or to a serial adapter on your mobile computer.
- 3 Open a communications program on your PC and configure the following parameters for the serial port:

Parameter	Default Setting
Baud rate	115200
Data bits	8
Parity	None
Stop bits	1

- 4 From the host PC, check the wireless settings.

If you have an IPL version of the printer, send these commands to the printer:

```
<STX><SI>wt,SSID<ETX>  
<STX><SI>wt,WEP1<ETX>  
<STX><SI>wt,WEP2<ETX>  
<STX><SI>wt,WEP3<ETX>  
<STX><SI>wt,WEP4<ETX>  
<STX><SI>wt,AUTH<ETX>  
<STX><SI>wt,WPA<ETX>
```







```
<STX><SI>wt , WPA2<ETX>  
<STX><SI>wt , WPA_PSK<ETX>  
<STX><SI>wt , ROAM<ETX>  
<STX><SI>wt , PWR_MODE<ETX>  
<STX><SI>wt , CHANNEL<ETX>  
<STX><SI>wt , AP_MAC<ETX>  
<STX><SI>wt , SIGNAL<ETX>  
<STX><SI>wt , SPEED<ETX>  
<STX><SI>wt , ACTIVE<ETX>
```

If you have a Fingerprint version of the printer, send this command to the printer:

```
setup write "wlan", "uart1:"
```

- 5 Set up the printer to use the correct SSID and authentication modes. See one of the following procedures to configure wireless printing on your IPL or Fingerprint printer.
- 6 If you are going to use certificates for validation, transfer the certificate to the printer. The printer can accept .pfx, .pem, and .der certificates.
- 7 Verify that the printer is connected to the access point and make sure it has an IP address allocated to it.

Understanding the 802.11 Radio Icons

Icon	Description
	Excellent signal
	Strong signal
	Good signal
	Weak signal
	Poor signal
	No signal

Use the following sections to set most of your wireless communication settings. For help with additional commands and information, see either the *Fingerprint Command Reference Manual* or the *IPL Command Reference Manual*. You can download both documents from the Intermec web site at www.intermec.com.

Configuring Wireless Printing Using IPL

Use the following procedures to configure your printer with IPL for wireless printing.

To configure the printer to use WEP authentication

- 1 Send the following commands to login as an admin and set the SSID:

```
<STX><ESC>.x,su -p pass admin<ETX>  
<STX><SI>ws,SSID,xxxxxx<ETX>
```

where *xxxxxx* can be from 0 to 32 ASCII characters, not including the double quote.



Note: The default password for logging in as an admin is “pass.” If you have changed the password, you will need to use your password instead of “pass.”

- 2 Send the following commands to configure the WEP keys. The following example sets WEP key 1 to 1234 and enables WEP key 1.

```
<STX><SI>ws,WEP1,0x0001020304<ETX>  
<STX><SI>ws,.WEP_KEY,1<ETX>
```

- 3 Send the following command to activate the settings.

```
<STX><SI>ws,ACTIVE,1<ETX>
```

To configure the printer to use WPA-PSK or WPA2-PSK mode

- 1 Send the following commands to login as an admin and set the SSID:

```
<STX><ESC>.x,su -p pass admin<ETX>  
<STX><SI>ws,SSID,xxxxxx<ETX>
```

where *xxxxxx* can be from 0 to 32 alphanumeric characters.

- 2 Send one of the following commands to turn on WPA or WPA2 authentication. Send the WPA-PSK or WPA2-PSK command to set a pre-shared key:

```
<STX><SI>ws , WPA , ON<ETX>  
<STX><SI>ws , WPA2 , ON<ETX>  
<STX><SI>ws , WPA_PSK , xxxxxxxxxxxx<ETX>
```

where *xxxxxxxxxx* is a value between 8 and 64 characters.

- 3 Send the following command to activate the settings:

```
<STX><SI>ws , ACTIVE , 1<ETX>
```

To configure the printer to use WPA or WPA2 Enterprise mode

- 1 Send the following commands to login as an admin and set the SSID:

```
<STX><ESC> .x , su -p pass admin<ETX>  
<STX><SI>ws , SSID , xxxxxx<ETX>
```

where *xxxxxx* can be from 0 to 32 alphanumeric characters.



Note: The default password for logging in as an admin is “pass.” If you have changed the password, you will need to use your password instead of “pass.”

- 2 Send one of the following commands to enable WPA-802.1x or WPA2-802.1x authentication. You should also send the WPA_PSK command that does not contain a value:

```
<STX><SI>ws , WPA , ON<ETX>  
<STX><SI>ws , WPA2 , ON<ETX>  
<STX><SI>ws , WPA_PSK , <ETX>
```

- 3 Send these commands to configure the EAP_TYPE:

```
<STX><SI>ws , EAP_TYPE , xxxx<ETX>
```

where *xxxx* can be OFF, LEAP, PEAP, or TTLS.

```
<STX><SI>ws , . EAP_USER , xxxx<ETX>  
<STX><SI>ws , . EAP_PASS , xxxx<ETX>
```

where *xxxx* is the unique username and the unique password for this protocol.

- 4 If you are using TTLS, you may need to send this command to set the TTLS outer name:

```
<STX><SI>ws , TTLS_USER , xxxx <ETX>
```

where *xxxx* is the outer name.

- 5 If you are using certificates for validation, here are some commands you may need to use.

- Send the following commands to set a certificate and enable validation:

```
<STX><SI>ws, CA_CERT, c:/testCA.pfx@export<ETX>  
<STX><SI>ws, VALIDATE, ON<ETX>
```

where *c:/testCA.pfx* is the location and name of the certificate and *export* is the passphrase.

- Send the following commands to set a common name for server 1 and server 2:

```
<STX><SI>ws, .SERVER_CN1, xxxxxxxxxxxx <ETX>  
<STX><SI>ws, .SERVER_CN2, xxxxxxxxxxxx <ETX>
```

where *xxxxxxxxxx* can be a value from 0 to 64 characters.

- Send the following command to make sure your values match those used by the access point:

```
<STX><SI>wt, [variable name] <ETX>
```

All variables are returned with the exception of EAP_PASS which always returns “****” if configured and CA_CERT which transmits the name of the last certificate authority successfully installed. An additional read-only variable for the supplicant state, called STATE, is also returned.

- You may need to send the following command several times for the wireless station to connect:

```
<STX><SI>ws, ACTIVE, 1<ETX>
```

Configuring Wireless Printing Using Fingerprint

Use the following procedures to configure your printer with Fingerprint for wireless printing.

To configure the printer to use WEP authentication

- 1 Send the following commands to login as an admin and set the SSID:

```
run"su -p pass admin"  
setup write "wlan", "uart1:"  
setup "wlan", "SSID", "xxxxxx"
```

where *xxxxxx* can be from 0 to 32 ASCII characters, not including the double quote.



Note: The default password for logging in as an admin is “pass.” If you have changed the password, you will need to use your password instead of “pass.”

- 2 Send the following commands to configure the WEP keys. The following example sets WEP key 1 to 1234 and enables WEP key 1.

```
setup "wlan", "WEP1", "0x0001020304"  
setup "wlan", ".WEP_KEY", "1"  
setup "wlan", "ACTIVE", "1"  
setup write "wlan", "uart1:"
```

To configure the printer to use WPA-PSK or WPA2-PSK mode

- 1 Send the following commands to login as an admin and set the SSID:

```
run"su-p pass admin"  
setup write "wlan", "uart1:"  
setup "wlan", "SSID", "xxxxxx"
```

where *xxxxxx* can be from 0 to 32 alphanumeric characters.

- 2 Send one of the following WPA/WPA2 ON commands to turn on WPA or WPA2 authentication. Send the WPA-PSK or WPA2-PSK command to set a pre-shared key:

```
setup "wlan", "WPA", "ON"  
setup "wlan", "WPA2", "ON"  
setup "wlan", "WPA_PSK", "xxxxxxxxxxxxx"  
setup "wlan", "ACTIVE", "1"  
setup write "wlan", "uart1:"
```

where *xxxxxxxxxxxxx* is a value between 8 and 64 characters.

To configure the Printer to use WPA or WPA2 Enterprise mode

- 1 Send the following commands to login as an admin and set the SSID:

```
run"su-p pass admin"  
setup write "wlan","uart1:"  
setup "wlan","SSID","xxxxx"
```

where *xxxxx* can be from 0 to 32 alphanumeric characters.

- 2 Send one of the following WPA/WPA2 ON commands to set up WPA-802.1x or WPA2-802.1x authentication. You should also send the WPA_PSK command that does not contain a value:

```
setup "wlan","WPA","ON"  
setup "wlan","WPA2","ON"  
setup "wlan","WPA_PSK",""  
setup write "wlan","uart1:"
```

- To view the 802.1x values, send this command:

```
setup write "8021x","uart1:"
```

- 3 Send these commands to configure the EAP_TYPE:

```
setup "8021x","EAP_TYPE","xxxx"
```

where *xxxx* can be OFF, LEAP, PEAP, or TTLS.

```
setup "8021x",".EAP_USER","xxxx"  
setup "8021x","EAP_PASS","xxxx"
```

where *xxxx* is the unique username and the unique password for this protocol.

- 4 If you are using TTLS, you may need to send this command to set the TTLS outer name:

```
setup "8021x","TTLS_USER","xxxx"
```

where *xxxx* is the outer name.

- 5 If you are using certificates for validation, here are some commands you may need to use.

- Send the following commands to set a certificate and enable validation:

```
setup "8021x","CA_CERT","c:/test.pfx@export"  
setup "8021x","VALIDATE","ON"
```

where *c:/test.pfx* is the location and name of the certificate and *export* is the passphrase.

- Send the following commands to set a common name for server 1 and server 2:

```
setup "8021x", ".SERVER_CN1", "xxxxxxxxxxxx"  
setup "8021x", ".SERVER_CN2", "xxxxxxxxxxxx"
```

where *xxxxxxxxxxxx* can be a value from 0 to 64 characters.

- Send the following command to make sure your values match those used by the access point:

```
setup write "8021x", "uart1:"
```

- You may need to send the following command several times for the wireless station to connect:

```
setup "wlan", "ACTIVE", "1"<ETX>
```

Configuring the Printer Settings

You can change the configuration settings of the printer directly from:

- from the display.
- from the host PC using PrintSet.
- from the host PC using the command line.
- from the printer home page.
- from the SmartSystems Console.

For more information on the IPL and Fingerprint menu systems, see **“IPL Setup Menu” on page 76**.

Changing Configuration Settings From the Display

You need to enter Setup mode before you can change configuration settings. For more information on entering Setup mode and navigating through the settings, see **“Understanding Setup Mode” on page 18**.

The top levels of the Setup menu are organized in a one-way loop. Each level has several sub-levels.

Note: The ESC/P printer does not have a Setup menu.





Note: If you have a Bluetooth or radioless printer, you will not see the NETWORK setup menu in Fingerprint or IPL.

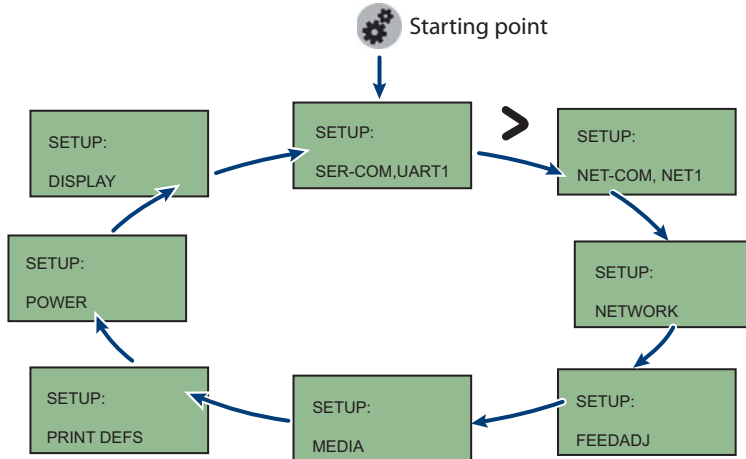

The Main Levels of the Setup Menu in Fingerprint

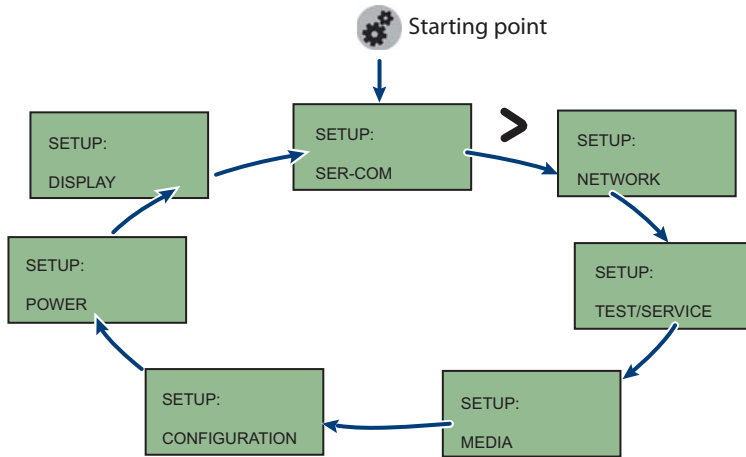

The Main Levels of the Setup Menu in IPL

Changing Configuration Settings From PrintSet

PrintSet Version 4.2 (or later) is a printer configuration tool that you can download from the Intermec web site and install on a host PC. PrintSet can communicate with your printer through a serial cable or a network connection. It works on all PCs running Windows 98 (or later). PrintSet allows you to easily change all of the setup parameters. It also includes setup wizards to guide you through some common configuration tasks. For more help using PrintSet, see the online help.

Changing Configuration Settings Using the Command Line

You can change configuration parameters by sending commands directly to the printer using a communications program like HyperTerminal and a serial or network connection.

If your printer uses the Fingerprint language, you use the SETUP command, followed by the node, subnode, and parameters setting. Here is a Fingerprint example that sets your media setting to labels with gaps:

```
SETUP "MEDIA, MEDIA TYPE, LABEL (w GAPS) "
```

If your printer uses the IPL language, you would send this command:

```
<STX><SI>T1<ETX>
```

Fingerprint automatically sends feedback to the communications program as you type. If you want to see what you are typing with IPL, you need to complete the following procedure.

To see IPL commands as you type

- 1 From the HyperTerminal menu, select **File > Properties > the Settings** tab.
- 2 Click the **ASCII Setup** button.
- 3 Select **Echo typed characters locally**.
- 4 Click **OK** twice.

For more information on how to change configuration settings, see either the *Fingerprint Command Reference Manual* or the *IPL Command Reference Manual*. You can download both documents from the Intermec web site at www.intermec.com.

Changing Configuration Settings From the Printer Home Page

If you have a printer with an 802.11 wireless radio, you can change configuration settings from the home page of the printer.

To make changes to the configuration

- 1 Establish a connection between your printer and the network. For help see **“Setting Up 802.11 Radio Communications” on page 30**.
- 2 Connect your PC to the same network that the printer is on.
- 3 If you are using Fingerprint or IPL, do the following to find the IP address:
 - a Press the **Setup** button .
 - b Press the **➤** until you reach **Network**.
 - c Press **OK** to enter the Network system menu.
 - d Press **➤** until you reach **IP address**.
 - e Press **OK** to view the IP address.
- 4 If you are using ESC/P, use a communications program to find the IP address.
 - a Start a communications program.
 - b In the communications program window, type:
`ESC{QST:NW}`
and press **Enter**. The IP address of the printer appears in the communications program window.
- 5 Start a web browser.

- 6 In the address field, type the IP address of your printer and press **Enter**. The home page of the printer appears.



- 7 Click Login and enter your administrator name and password.
- 8 On the home page of the printer, click **Configuration**.

For help with Fingerprint, IPL, ESC/P, or SmartSystems Foundation commands and information, see either the *Intermec Fingerprint Command Reference Manual*, the Intermec *Printer Language (IPL) Command Reference Manual*, the *ESC/P Programmer's Reference Manual*, or SmartSystems Foundation online help. You can download these documents from the Intermec web site at www.intermec.com.

Changing Configuration Settings From the SmartSystems Console

You can use the SmartSystems Console to change configuration settings on your printer. The printer ships with the SmartSystems client loaded on it. The console is part of SmartSystems Foundation and is available from the Intermec web site. To download SmartSystems Foundation, go to www.intermec.com/products/smrtsysfoundation/index.aspx.

Upgrading the Firmware

The latest firmware and software is available for download from the Intermec web site at www.intermec.com. You can upgrade the firmware on your printer using:

- PrintSet. You can download PrintSet from the downloads page for the printer on the Intermec web site at www.intermec.com.
- the printer home page.
- SmartSystems™ Foundation.
- a communications program like HyperTerminal.



When upgrading your firmware, make sure the battery in the printer is fully charged. If the printer loses power during the upgrade, the printer may be permanently damaged.

Upgrading the Printer Firmware Using PrintSet

You can only upgrade your printer using PrintSet when the printer is running IPL, Fingerprint, or ESC/P printer languages. To upgrade the printer using PrintSet, you need to install PrintSet to your PC and purchase a serial cable (P/N 075497).

To upgrade the printer firmware using PrintSet

- 1** Connect your printer to your printer using a serial cable. For help, see **“Connecting the Printer Through the Serial Port” on page 27**.
- 2** Download the firmware (.bin) file you want to upgrade to a location on your PC.
 - a** Go to www.intermec.com.
 - b** Click **Support > Downloads**.
 - c** Use the **Product Category**, **Product Family**, and **Product fields**, to select the printer model.
 - d** Click **Submit**. The latest available software appears on the page.
 - e** Download the latest firmware version to your PC.
 - f** Extract the .zip file to a folder on your PC.

3 Open PrintSet. The Intermec PrintSet dialog box appears.

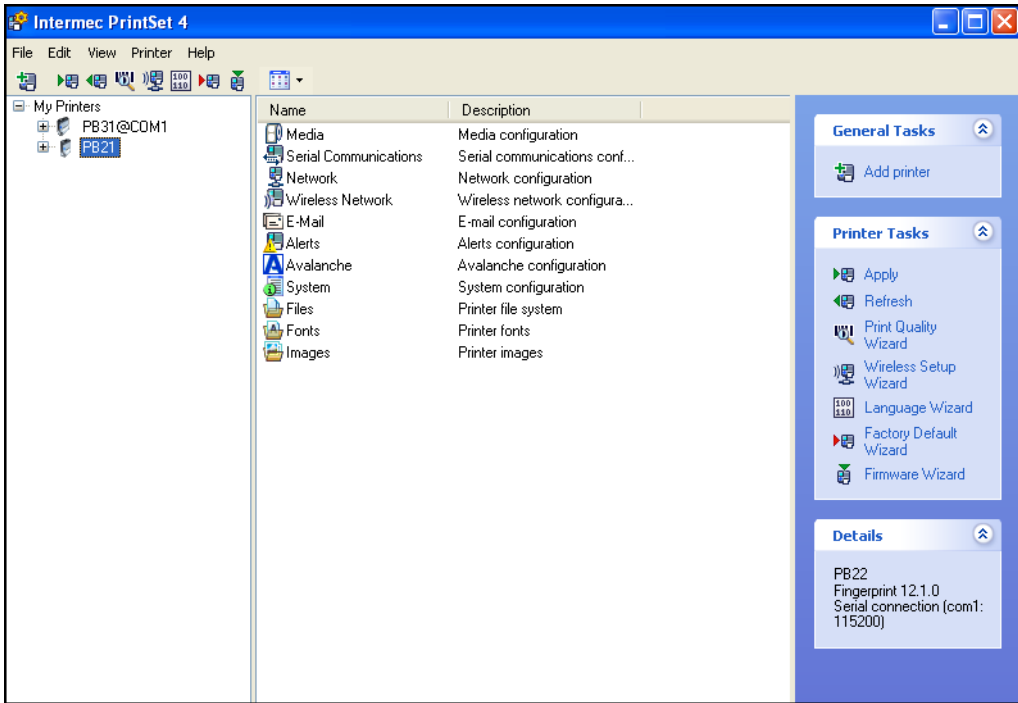

- 4 Under My Printers, click the printer whose firmware you want to upgrade.
- 5 Under Printer Tasks in the right-hand column, click **Firmware Wizard**.
- 6 Click **Next**. The Firmware Wizard dialog box appears.
- 7 Click **Browse** and navigate to the firmware (.bin) file you want to use. Wait approximately five minutes as your printer upgrades to the new firmware.

Upgrading the Printer Firmware Using the Printer Home Page

You can upgrade your printer using the printer home page with a printer with an 802.11 radio running IPL or Fingerprint.

To upgrade using the printer home page

- 1 Establish a connection between your printer and the network. For help, see “**Setting Up 802.11 Radio Communications**” on page 30.
- 2 Establish a connection between your PC and the network your printer is on.
- 3 Download the firmware (.bin) file you want to upgrade to a location on your PC.
 - a Go to www.intermec.com.
 - b Click **Support** > **Downloads**.
 - c Use the **Product Category**, **Product Family**, and **Product fields**, to select the printer model.
 - d Click **Submit**. The latest available software appears on the page.
 - e Download the latest firmware version to your PC.
 - f Extract the .zip file to a folder on your PC.
- 4 If you are using Fingerprint or IPL, use the display to find the IP address of the printer.
 - Press the **Setup** button.
 - Press **▶** until you reach Network.
 - Press **OK** to enter the Network menu.
 - Press **▶** until you reach IP Address.
 - Press **OK** to select and view the IP Address.
 - Press the **Setup** button to exit the menu.
- 5 Start a web browser.

- 6 In the address field type the IP address of your printer and press **Enter**.



INTERMEC000000 [Home](#) [Configuration](#) [Maintenance](#) [Support](#)

EasyCoder PB50

Name (WINS):	INTERMEC000000
Firmware Version:	MCS 1864, 12-Oct-07 14:16:56
Active Command Set:	FP 11.1.0 Beta3
MAC Address:	00:1A:73:40:93:EF
IP Address:	10.20.111.211
Image buffer:	label.png
RtW™:	Operational

7 Click **Maintenance**. The Maintenance page appears.

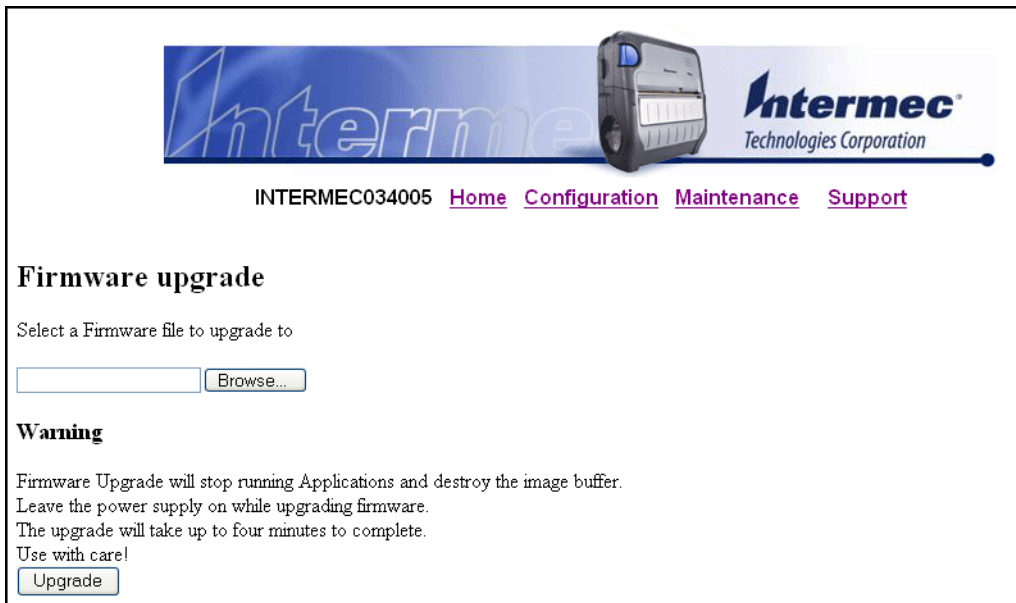

INTERMECC034005 [Home](#) [Configuration](#) [Maintenance](#) [Support](#)

Firmware upgrade

Select a Firmware file to upgrade to

Warning

Firmware Upgrade will stop running Applications and destroy the image buffer.
Leave the power supply on while upgrading firmware.
The upgrade will take up to four minutes to complete.
Use with care!

8 When prompted, enter your user name and password. The default user name is “admin” and the default password is “pass.”

9 Browse to the (.bin) file you want to upgrade to and select it.

10 Click **Upgrade**.

Wait approximately five minutes for the firmware upgrade to complete. The printer automatically reboots.

Upgrading Printer Firmware Using SmartSystems Foundation

You can use the SmartSystems console to upgrade the printer firmware. Your printer ships with the SmartSystems client loaded on it. The console is part of SmartSystems Foundation and is available from the Intermecc web site. To download SmartSystems Foundation, go to www.intermec.com/products/smrtsysfoundation/index.aspx.

Upgrading the Printer Firmware Using a Communications Program

You can upgrade your printer firmware using a communications program like HyperTerminal and a printer running either the IPL, Fingerprint or ESC/P printer language. Using a communications program is not the preferred method for upgrading printer firmware. When possible, upgrade using PrintSet or the home page of the printer.

To upgrade the printer firmware using a communications program and IPL

- 1 Connect your printer to your PC using a serial cable. For help, see [“Connecting the Printer Through the Serial Port” on page 27.](#)
or
Establish a connection between your printer and your network [“Connecting the Printer to Your Network” on page 29.](#)
- 2 If you connected your printer to the network, establish a connection between your PC and the network your printer is on.
- 3 Download the firmware (.bin) file you want to upgrade to a location on your PC.
 - a Go to www.intermec.com.
 - b Click **Support** > **Downloads**.
 - c Use the **Product Category**, **Product Family**, and **Product fields**, to select the printer model.
 - d Click **Submit**. The latest available software appears on the page.
 - e Download the latest firmware version to your PC.
 - f Extract the .zip file to a folder on your PC.
- 4 Open a communications program. The communications program window appears.
- 5 In the window, type:
`<STX><ESC> . y , ush<ETX>`
and press **Enter**. You will be prompted for more data.

6 Type:

```
su -p pass admin.
```

and press **Enter**.

7 Type:

```
dlk -z
```

and press **Enter**.

The printer's display will read "Upgrading".

8 In the communications program window, click **Transfer > Send File**. A dialog box will appear.

9 In the protocol drop-down box, choose **Zmodem**.

10 Browse to the firmware (.bin) file you want to upgrade to and select it.

Wait approximately five minutes for the firmware upgrade to complete. When the upgrade is complete, the communications program will display "kernal flashing ok." The printer automatically reboots.

To upgrade the printer firmware using a communications program and Fingerprint

1 Connect your printer to your PC using a serial cable. For help, see "[Connecting the Printer Through the Serial Port](#)" on page 27.

2 Download the firmware (.bin) file you want to upgrade to a location on your PC.

a Go to www.intermec.com.

b Click **Support > Downloads**.

c Use the **Product Category**, **Product Family**, and **Product fields**, to select the printer model.

d Click **Submit**. The latest available software appears on the page.

e Download the latest firmware version to your PC.

f Extract the .zip file to a folder on your PC.

3 Open a communications program like HyperTerminal.

4 Type:

```
run "su -p pass admin"
```

and press **Enter**.

5 Type:

```
run "dlk -z"
```

and press **Enter**.

The printer's display will read "Upgrading".

6 In the communications program, click **Transfer > Send File**. A dialog box will appear.

7 In the protocol drop-down box, choose **Zmodem**.

8 Browse to the firmware (.bin) file you want to upgrade to and select it.

Wait approximately five minutes for the firmware upgrade to complete. When the upgrade is complete, the communications program will display "kernal flashing ok." The printer will automatically reboot.

To upgrade the printer firmware using a communications program and ESC/P

- 1 Connect your printer to your PC using a serial cable. For help, see ["Connecting the Printer Through the Serial Port" on page 27](#).
- 2 Download the firmware (.bin) file you want to upgrade to a location on your PC.
 - a Go to www.intermec.com.
 - b Click **Support > Downloads**.
 - c Use the **Product Category**, **Product Family**, and **Product fields**, to select the printer model.
 - d Click **Submit**. The latest available software appears on the page.
 - e Download the latest firmware version to your PC.
 - f Extract the .zip file to a folder on your PC.
- 3 Open a communications program like HyperTerminal.
- 4 Reboot the printer.

- 5 Press the **Esc** key and in the communications program window type:

```
{SYS:USH}
```

and press **Enter**.

- 6 Type:

```
su -pass admin
```

and press **Enter**.

- 7 Type:

```
dlk -z.
```

and press **Enter**.

The printer's display will read "Upgrading".

- 8 In the communications program window, click **Transfer > Send File**. A dialog box will appear.
- 9 In the protocol drop-down box, choose Zmodem.
- 10 Browse to the firmware (.bin) file you want to upgrade to and select it.
- 11 Browse to the firmware (.bin) file you want to upgrade to and select it.

Wait approximately five minutes for the firmware upgrade to complete. When the upgrade is complete, the communications program will display "kernal flashing ok." The printer will automatically reboot.

Downloading Fonts and Graphics

The easiest way to download fonts and graphics is to use the free Intermec printer application called PrintSet. You can download PrintSet from the downloads page for the your printer on the Intermec web site at www.intermec.com. Follow the procedures in the PrintSet online help to download fonts and graphics.

Chapter 2 – Configuring the Mobile Printer

You can also use Fingerprint, IPL, or ESC/P commands to send fonts and graphics to the printer. For help with commands and information, see either the *Fingerprint Command Reference Manual*, the *IPL Command Reference Manual*, or the *ESC/P Programmer's Reference Manual*. You can download these documents from the Intermec web site at www.intermec.com.

3

Troubleshooting and Maintaining the Mobile Printer

Use this chapter to solve problems you may encounter while using the printer. You will also find information on booting the printer and routine maintenance.

In this chapter, you will find these sections:

- **Troubleshooting the Mobile Printer**
- **Resetting the Mobile Printer**
- **Cleaning the Printer**

Troubleshooting the Mobile Printer

You may have printer operation, print quality, or printer communication problems at some time during the life of the printer. It is easy to fix most of the problems and you will find solutions in “**Troubleshooting Printer Problems and Finding Solutions**” on [page 56](#). If you cannot find the answer to your problem, you may need to contact Product Support.

Contacting Product Support

Before you call Intermec Product Support, you may want to visit the Intermec technical knowledge base (Knowledge Central). To do so, go to www.intermec.com and click **Support > Knowledge Central**. If you still need help after visiting Knowledge Central, you may need to call Product Support.

To talk to an Intermec Product Support representative in the U.S.A. or Canada, call:

1-800-755-5505

Outside the U.S.A. and Canada, go to www.intermec.com and click **Contact Us** to find your local Intermec representative.

Before you call Intermec Product Support, make sure you have the following information ready:









- Printer serial number
- Firmware type and version
- Bluetooth, wireless, or serial port settings

You can find all of the information listed above in the printer menu system or on a testprint page.

Understanding Error Messages

Use the following tables to troubleshoot some common error message you may see display on printer screen. Some of the error messages are specific to the type of firmware you have loaded on your printer.

Possible Printer Error Icons and Messages

Error Icon	Error Message	Description
	Pause	The print job is paused.
	Paper out (IPL) Out of Paper (Fingerprint)	The printer is out of paper. Load a new roll of media. For help, see “Loading Media” on page 11 .
	Testfeed not done	The printer did not perform a testfeed before it printed out test labels. It is important to perform a testfeed because it calibrates the sensor. To perform a testfeed: <ul style="list-style-type: none"> • In Fingerprint and ESC/P, press the Feed button for more than 2 seconds. • In IPL, open and close the media door and then press the Feed button.
	Printhead hot	The printhead is overheated and needs to cool down. In IPL, wait for printing to resume automatically. In Fingerprint and ESC/P, your print job is lost.
	Upgrading	The printer is loading new firmware.
	LSS too high, LSS too low	These errors can occur when you run a test feed without any media installed, or if you have incorrect media settings. Load the printer with media (see “Loading Media” on page 11), run Test mode (see), and select the appropriate media type.
	IP configuration error	The printer is trying to acquire an IP address from the network. Wait for the printer to complete the task before taking any action.
	IP link error	No network connection.
	Field out of label	You are attempting to print in an area that extends beyond the print window. See the command reference manual for your type of firmware (IPL, Fingerprint, or ESC/P) for information on how to set the media parameters.

Possible Printer Error Icons and Messages (continued)

Error Icon	Error Message	Description
	Printhead lifted	The printer is not completely closed. Press down on the media cover to make sure it is latched.

Troubleshooting Printer Problems and Finding Solutions

Use the following tables to troubleshoot some common problems you may encounter with the printer.

Printer Problems and Solutions

Problem	Possible Solution
The printer does not turn on when you press Standby .	<ul style="list-style-type: none"> • Replace the battery with a charged battery. • Connect external power to make sure the printer works correctly and to charge the battery.
The blue light (Ready-to-Work indicator) is blinking.	<ul style="list-style-type: none"> • Make sure media is loaded and the media cover is closed. For help, see “Loading Media” on page 11. • There is a printing error. The screen displays an error message containing information on the error. • The printer is paused. The printer is cancelling a print job.
Printer keeps printing or feeding when it should stop.	<ul style="list-style-type: none"> • Check media settings. • Make sure the label gap sensor is clean. For help, see “Cleaning the Printer” on page 60.
The printout is not in the desired position.	<ul style="list-style-type: none"> • Check for errors in the software application. • Make sure the label gap sensor and platen roller are clean.
The printer is not printing with an 802.11 wireless connection.	<ul style="list-style-type: none"> • Verify that the wireless settings are correct. For help, see “Setting Up 802.11 Radio Communications” on page 30. • Make sure the printer has an IP address. • Make sure the printer is connected to the network. • Make sure the printer is in Ready mode.

Printer Problems and Solutions (continued)

Problem	Possible Solution
The printer is not printing with a Bluetooth connection.	<ul style="list-style-type: none"> • Re-establish a Bluetooth connection with the mobile computer or scanner. For help, see your mobile computer user's manual or "Setting Up Bluetooth Communications" on page 29. • Make sure the mobile computer can print to a known good printer. • Print a Bluetooth testprint page to make sure that the mobile printer discovered your printer. For help, see "Printing a Test Page" on page 22. • Make sure the printer is in Ready mode.
When printing, the printer is skipping labels.	<p>Perform a testfeed:</p> <ul style="list-style-type: none"> • In Fingerprint or ESC/P, press the Feed button for more than 2 seconds. • In IPL, open and close the media door and then press the Feed button. • Make sure the label gap sensor is clean. For help, see "Cleaning the Printer" on page 60.
Printout is faded or weak.	<ul style="list-style-type: none"> • Fingerprint users: adjust the media constant/factor and contrast (-10% to +10%). • IPL users: adjust the media sensitivity setting (-10 to +10). • ESC/P users: Adjust the darkness. • Check to see if the printhead needs cleaning. For help, see "Cleaning the Printer" on page 60.
The battery charge is not lasting as long as it should.	<ul style="list-style-type: none"> • Check the battery date. If the battery is a few years old, the shortened life may be due to normal aging. • Replace the battery.
The test pages do not print.	<ul style="list-style-type: none"> • Make sure that the blue light is not blinking. If it is, make sure your printer has media and that the media cover is closed. • Make sure that you can advance media by pressing the Feed button.

Printer Problems and Solutions (continued)

Problem	Possible Solution
Print quality is poor.	<ul style="list-style-type: none">• Clean the printhead. For help, see “Cleaning the Printer” on page 60.• Check the battery and recharge or replace as necessary. For help, see “Charging the Batteries” on page 8.• Check the quality of the media. Use only Intermec media to ensure superior print quality and product performance.• Check that the printer is set to the appropriate Constant/Factory or sensitivity number for the media you are using.
Your printer cannot connect to PrintSet or HyperTerminal	<ul style="list-style-type: none">• Make sure that the serial cable is plugged in.• Check to make sure that all pins on the serial cable are straight and not bent.

Troubleshooting Communication Problems

Use Dump mode to verify that the printer is receiving data from the host correctly.

Using the Line Analyzer in Fingerprint

In Dump mode, the printer runs a Fingerprint program called Line Analyzer. The Line Analyzer captures incoming characters on the communication ports and prints them on one or more labels.

The easiest way to enter Dump mode is through Test mode or Extended Test mode. For help, see **“Understanding Test Mode” on page 20.**

After the printer enters Dump mode, it tells you it has entered Dump mode by printing it on a label. The display shows the Dump mode icon and printer is ready to receive data.

While the printer is receiving data, the Ready-to-Work indicator blinks. After a half of a second, if no more characters have been received, the printer times out. The program considers the transmission terminated and prints out a label.

Printable characters are printed in black-on-white. Control characters and space characters (ASCII 000 to 032 dec) are printed in white-on-black.

As long as a continuous string of characters is being received, the program wraps the lines until the label is full and then starts to print another label. After each character transmission, the following information prints:

- Page number
- Number of characters printed on the label
- Total number of characters received so far

When you exit Dump mode, a final label prints to inform you that it is exiting from Dump mode.

Using Dump Mode in IPL

When you enter Dump mode, the printer captures incoming characters on the communication ports and prints them on one or more labels.

If you have IPL firmware on your printer, you can access Dump mode in two different ways with slightly different results:

- You can access Dump mode through Test mode or Extended Test mode and you will receive printouts that look exactly like those produced with the Line Analyzer program in Fingerprint. For more information, see the previous procedure, [“Using the Line Analyzer in Fingerprint” on page 58](#).
- You can access Dump mode using the control panel buttons. If you access Dump mode this way, characters are printed on a continuous line along with corresponding hexadecimal numbers.

To enter Dump mode using the control panel buttons

- Press and hold the **Feed** and **Standby** buttons until the printer starts feeding out media.

The printer feeds out several labels (or inches of media), prints the test labels, and then enters Dump mode.

To exit Dump mode using the control panel buttons

- Press the **Feed** button.

Resetting the Mobile Printer

You rarely need to cold boot the printer, unless you are upgrading the firmware. If your printer occasionally locks up, you will want to cold boot it. A cold boot reinitializes the 802.11 radio and clears the working memory.



Note: The Setup menu is not affected by a cold boot. Your printer retains all of your configuration settings after the printer powers back up.

To reset the printer

- 1 Disconnect the printer from power if externally powered.
- 2 Remove the battery from the printer for at least one second.
- 3 Insert the battery back into the printer.
- 4 Reconnect external power if your printer is externally powered.

Cleaning the Printer

To properly maintain your printer, you must clean it at the recommended interval. Use the following illustration to locate the parts of your printer to clean.

Make sure to clean the following parts:

Printhead

Platen roller

Paper sensors

Tear bar

Printer exterior

Media compartment



Warning

To avoid possible personal injury or damage to the printer, never insert any pointed or sharp objects into the printer.



Caution

Use only the cleaning agents specified in this section. Intermec is not responsible for damage caused by any other cleaning materials used on this printer. Clean most of the printer with a cotton swab saturated with alcohol.



Caution

Do not clean the linerless platen roller with isopropyl alcohol. It could damage the surface of the platen roller.

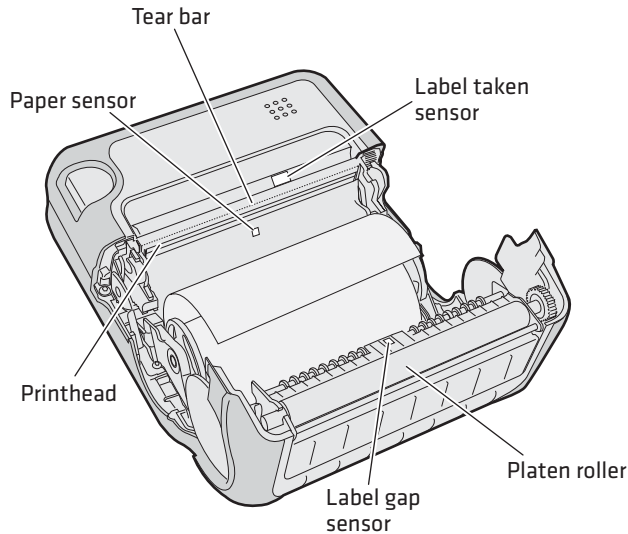

PB50 and PB51 Mobile Label and Receipt Printer: Identifying the parts of the printer to clean regularly

Cleaning the Printhead

Clean the printhead every five rolls of media to prolong the life of the printhead and ensures that you maintain high print quality.

Clean the printhead with the cleaning swab. The cleaning swab is shipped with the printer and can also be purchased separately from www.intermec.com.



Note: The cleaning swab is the recommended method for cleaning the printhead and platen roller. Using other methods for cleaning may damage the printer.

To clean the printhead

- 1 Open the media cover.
- 2 Remove the media and ribbon.
- 3 Use the cleaning swab to dissolve any contamination on the line of heat-emitting objects at the front/bottom of the printhead.
Or, clean thoroughly with 70% isopropyl alcohol and a cotton swab.
- 4 Wait 30 seconds and carefully rub off any contamination.
- 5 Repeat Steps 4 and 5 if necessary.
- 6 Allow the printhead to dry for a minute or more before loading a new supply of media and ribbon.

Cleaning the Platen Roller

Regular cleaning of the platen roller every five rolls of media prolongs the life of the printhead and ensures that you maintain high print quality.

Clean the printhead with the cleaning swab. The cleaning swab is shipped with the printer and can also be purchased separately from www.intermec.com.



Note: The cleaning swab is the recommended method for cleaning the printhead and platen roller. Using other methods for cleaning may damage the printer.

To clean the platen roller

- Rotate the platen roller and clean it thoroughly with the cleaning swab.

Be sure to clean the following parts using the cleaning swab:

- Paper sensors
- Tear bar

Cleaning the Printer Exterior

Make sure to keep the exterior of the printer clean, this will reduce the risk of dust or foreign particles reaching the inside of the printer and affect printer functionality.

To clean the printer exterior

- 1** Close the media cover.
- 2** Use a soft cloth, possibly moistened with water or a mild detergent and wipe the printer exterior.

Make sure to keep the surface surrounding the printer clean as well.

Cleaning the Printer Media Compartment

- 1** Open the media cover.
- 2** Remove the media and ribbon.
- 3** Use a brush or air blow the compartment.

Make sure the paper sensors are free of dust.

A

Specifications

Specifications

Physical Dimensions

Depth:	78.7 mm (3.1 in)
Height:	174.5 mm (6.9 in)
Width:	159.5 mm (6.3 in)
Weight:	1190 g (2 lb) with battery

Power Specifications

AC power adapter voltage:	100 to 240V
Printer voltage:	100V to 240V and 50 Hz to 60 Hz
Operating power:	Rechargeable 16.8 V 2200 mAh lithium-ion battery

Temperature and Humidity Specifications

Operating temperature:	-15°C to 50°C (5°F to 122°F)
Storage temperature:	-22°C to 70°C (-30°F to 158°F)
Charging temperature:	0°C to 45°C (32°F to 113°F)
Relative humidity:	0 to 95% non-condensing
Sealing:	IP54 is used. The paper path and slots are excluded from IP54.

Memory

RAM:	16 MB
Flash:	64 MB

Print Speed and Resolution

Print speed:	up to 4 ips (100 mm/s)
Resolution:	203 dpi (8 dots/mm)

Print Technology

Printhead:	Direct thermal
Maximum print width:	108 mm (4.25 in)

Media Specifications

Core inside diameter, standard:	19 mm (0.75in)
Core inside diameter, with adapter:	10.2 mm (0.4 in)
Maximum roll outside diameter:	67.3 mm (2.65 in)
Media width, label with liner/ receipt:	49mm (1.9 in) to 111.5 mm (4.4 in)
Media length, label:	25.4 mm (1.0 in) to 609.6 mm (24 in)
Media length, receipt:	Continuous
Media caliper, label with liner/ receipt:	0.05 mm (0.002 in) to 0.165 mm (0.0065 in)
Media caliper, tag (maximum):	0.15 mm (0.006 in)
Gap length (centered on perforation):	3.17 mm (0.125 in) to 12.7 mm (0.50 in)
Notch length (centered on perforation):	6.35 mm (0.25 in)
Notch width (centered on perforation):	12.7 mm (0.50 in)
Black mark length (centered on perforation):	3.17 mm (0.125 in) to 12.7 mm (0.50 in)
Black mark width (centered on media width):	Full width of media

Receipt roll stock media is supplied as a continuous roll. Label, tag, and fanfold media use repeat indicators for non-continuous media. Gap, notch, and black marks are used as repeat indicators:

- **Gap:** Label and fanfold media
- **Notch:** Tag media
- **Black mark:** Label, tag, and fanfold media

Here are a few things to keep in mind when ordering media for the printer:

Appendix A – Specifications

- Black marks can only be sensed on the back side of the media.
- You can use higher caliper media in the printer, but print quality will be reduced.
- Receipt roll stock media has an end of roll indicator. The end of roll indicator is a red marking (on last 3 feet of roll) on the thermally sensitive side of the

External Fanfold Media Specifications

Stack height:	70 mm (2.75 in)
Page length:	152 mm (6 in) to 305 mm (12 in)



Note: A 6-inch page length is supplied in 12-inch long stacks (two 6-inch stacks of equal height with the bottom page linked).

Specialty media is required for unique customer environments, including printer operating temperature extremes. Media performance is format and environment dependent. Not all media will work in all customer applications. Intermec recommends that you test the media in your application.

Supported Media

All models of the mobile printer support direct thermal label, tag, and receipt media. Both North American and European label media are supported in multiple label lengths. Receipt media is supported in both a top coated and an uncoated paper in continuous roll stock only.

The default media sensitivity number is 180.

The default media sensitivity number for linerless media is 103

Use the following table as a guide when setting sensitivity numbers.

Recommended Media Sensitivity, Constant, Factor, and Print Speed

Sensitivity	Constant	Factor	Description	Max Print Speed
North American Label Media				
720	60	40	Duratherm Lightning Plus	4 ips
470	52	40	Duratherm Lightning	4 ips
450	48	40	Duratherm Lightning	2 ips
430	100	40	Duratherm Synthetic	4 ips
180	80	40	Duratherm II Label	4 ips
180	80	40	Duratherm III Label	4 ips
180	80	40	Duratherm Near IR	4 ips
150	50	40	Duratherm 5 mil Tag	2 ips
North American Label Media (continued)				
103	110	45	Direct Thermal Linerless	Dependent on format and environment
North America Receipt Media				
401	45	40	Duratherm TC	2 ips
102	32	40	Duratherm NTC - 2	2 ips
101	30	40	Duratherm NTC	2 ips
European Label Media				
440	47	30	Thermal Eco	2 ips
140	70	40	Thermal Top	4 ips

Interfaces

This section describes the standard interfaces available on the PB50 and PB51 printers.

RS-232 Serial Interface

Use the following tables and graphics to understand the default settings of the serial port.

Default Settings of the Serial Port

Parameter	Default Setting
Baud rate	115200
Character Length or Data Bits	8
Parity	None
Stop Bits	1
Handshaking	none (Fingerprint XON/XOFF (IPL))

The illustration below shows printer end of the serial cable.

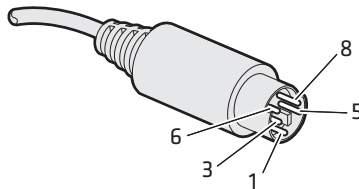

Serial Cable (Printer End)

Serial Cable Pins and Descriptions (Printer End)

Pins	Signal	Description
1	HHC RXD	Receive data from host (input)
3	HHC CTS	Clear to send from printer (output)
5	HHC RTS	Request to send from host (input)
6	HHC TXD	Transmit data to printer (output)
8	GND	Ground

The illustration below shows the PC end of the serial cable.

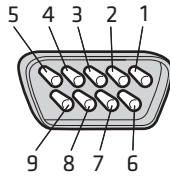

RS-232 Serial Cable DB9 Pins

Serial Cable Pins and Description (PC End)

Pin	Signal	Description
1	DCD	Data carrier detect
2	RXD	Receive data from host (input)
3	TXD	Transmit data to printer (output)
4	DTR	Data terminal ready
5	GND	Ground
6	DSR	Data set ready
7	RTS	Request to send from host (input)
8	CTS	Clear to send from printer (output)
9	RI	Ring indicator

USB Interface

To use the USB interface to print from a PC, you need to have the Intermec InterDriver printer driver installed on your PC. For help setting up USB communications, see **“Connecting the Printer Through the USB Interface” on page 26**.

The USB cable that ships with the printer has a USB Type A connector on one end to connect to the PC and a USB Type B connector on the other end to connect to the printer. You do not need to configure communications for the USB port.

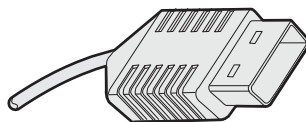

USB Type A Connector

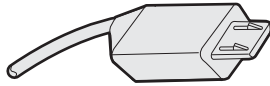

USB Type B Connector

Accessories for the Mobile Printer

You can use these accessories (sold and ordered separately) with the printer. To order accessories, contact your local Intermec sales representative.

AB13 Battery

Use the lithium-ion 2200 mAh battery to provide power to the printer.

AC18 4-Bay Battery Charger

Use the AC18 to charge up to four batteries at a time. The battery charger is designed to sense when a battery is fully charged and not overcharge it, ensuring long and consistent battery life.

AV8 Vehicle Cradle

Use the vehicle cradle to attach the printer to a truck or forklift. You will need the forklift power supply kit to connect your vehicle power to the printer.

Belt Clip

Use the printer belt clip to attach the printer to your belt.

Cart Dock

Use the cart dock to easily attach the printer to a movable cart or a flat surface.

Forklift Power Supply Kit

Use the forklift power supply kit to connect the printer and vehicle cradle to a truck or forklift.

Handstrap

Use the printer handstrap to conveniently carry your printer. With the handstrap attached, you can also attach the printer shoulder strap.

Intermec Cleaning Swab

Use the Intermec cleaning swab to clean the printhead and platen roller. One cleaning swab is included in the box with the printer. You can also purchase the cleaning swab from www.intermec.com.

Power Supply (Model AE19)

Provides power to the mobile printer and the 4-bay battery charger (Model AC18).

Printhead Cleaning Pen

Use the cleaning pen to clean the printhead.

Protective Case

Use the protective case to transport and store your printer. The protective case keeps the printer free of dust, dirt, and moisture and still provides easy access to the printer for printing.

Serial Cable

The serial adapter is an 8-pin DIN to DB9 connector that connects from the printer to your desktop PC.

Shoulder Strap

Use the shoulder strap in combination with the handstrap to easily carry the printer. The wide padded strap makes it comfortable to wear the printer for long periods of time.

B

IPL and Fingerprint Setup Menus

IPL Setup Menu

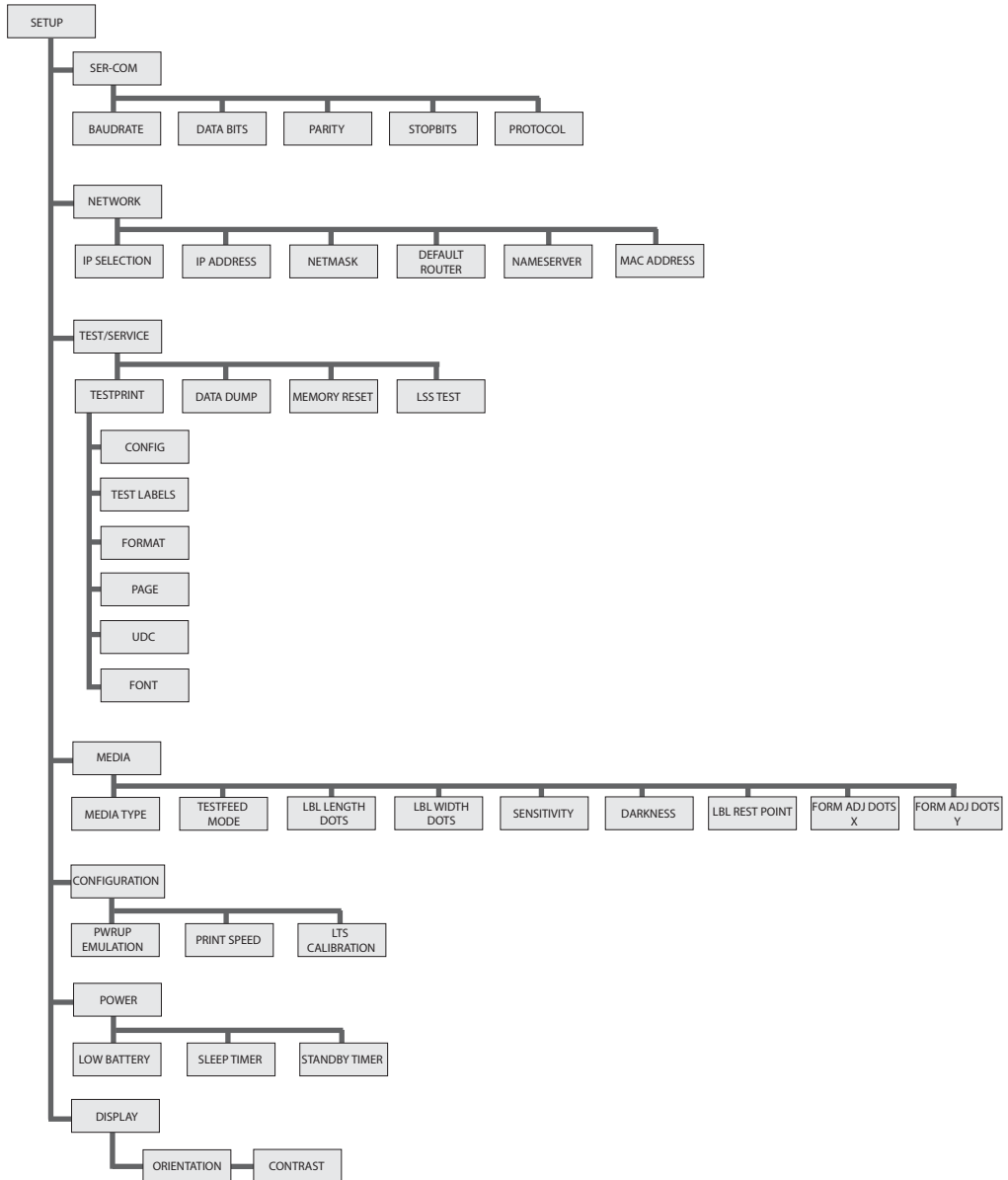

Fingerprint Setup Menu

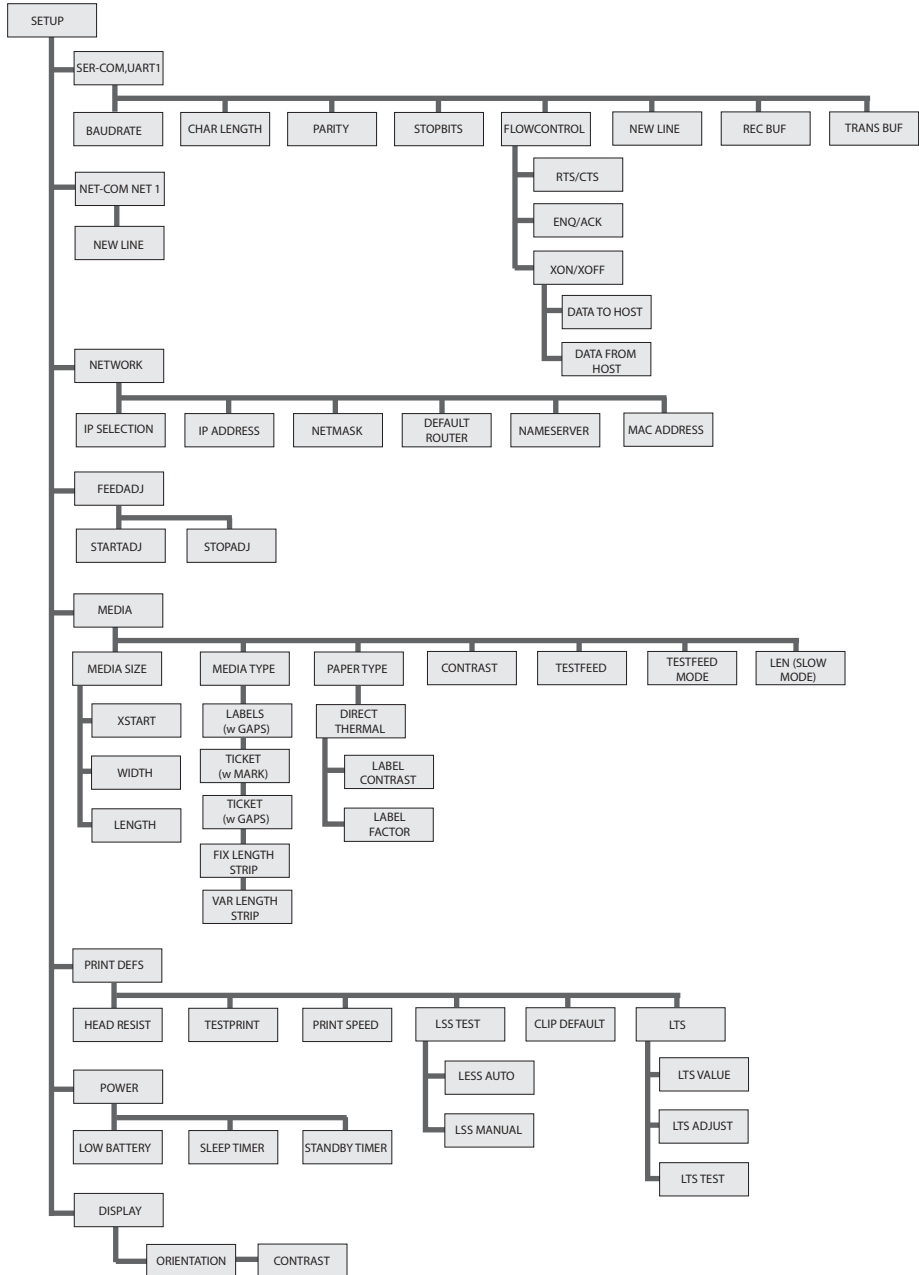

Appendix B – IPL and Fingerprint Setup Menus



Worldwide Headquarters
6001 36th Avenue West
Everett, Washington 98203
U.S.A.

tel 425.348.2600

fax 425.355.9551

www.intermec.com

© 2010 Intermec Technologies
Corporation. All rights reserved.

PB50 and PB51 Mobile Printer User's Guide



P/N 934-012-004