

# Dell Pro Stereo Headset UC150



## User's Guide

Regulatory model: UC150



# Notes, cautions, and warnings

---

-  **NOTE:** A NOTE indicates important information that helps you make better use of your computer.
-  **CAUTION:** A CAUTION indicates potential damage to hardware or loss of data if instructions are not followed.
-  **WARNING:** A WARNING indicates a potential for property damage, personal injury, or death.

Copyright © 2017 Dell Inc. All rights reserved. This product is protected by U.S. and international copyright and intellectual property laws. Dell™ and the DELL logo are trademarks of Dell Inc. in the United States and/or other jurisdictions. All other marks and names mentioned herein may be trademarks of their respective companies.

2017 – 03

Rev. A00

# Contents

<b>About your headset</b> . . . . .	<b>5</b>
Product features . . . . .	5
Intuitive control unit. . . . .	5
Plug-and-play setup. . . . .	5
Made for voice and music. . . . .	5
Easy call management . . . . .	5
Passive noise cancellation . . . . .	5
<b>What's in the box</b> . . . . .	<b>6</b>
<b>Features</b> . . . . .	<b>7</b>
Headset. . . . .	7
Call-control unit . . . . .	8
<b>Setting up your headset</b> . . . . .	<b>9</b>
Plug the headset into your computer . . . . .	9
Configure the headset on your computer . . . . .	10
Configuration for Skype for Business. . . . .	10
Configuration for other softphones. . . . .	10
Configuration to listen to music. . . . .	11
Adjusting the headset . . . . .	13
Answering/ending a call . . . . .	14
Answer an incoming call on the computer . . . . .	14
End an incoming call on the computer . . . . .	14
Adjusting the volume. . . . .	15
Muting/unmuting a call . . . . .	15
<b>Troubleshooting</b> . . . . .	<b>16</b>

Common symptoms . . . . .	16
<b>Specifications. . . . .</b>	<b>20</b>
General . . . . .	20
Physical characteristics . . . . .	20
Environmental . . . . .	20
<b>Statutory information. . . . .</b>	<b>21</b>
Warranty . . . . .	21
Limited warranty and return policies . . . . .	21
For U.S. customers: . . . . .	21
For European, Middle Eastern and African customers: . . . . .	21
For non-U.S. customers: . . . . .	21

# About your headset

---

## Product features

The features of the Dell Professional Stereo Headset UC150 include:

### Intuitive control unit

Get easy access to the most used functions, such as volume and mute. You can also answer and end calls directly from the control unit.

### Plug-and-play setup

The headset works out of the box with all leading systems. Installation is as easy as plugging the headset to your device.

### Made for voice and music

World-class speakers built for both voice and music. Quickly and easily switch between conversing and listening to your favorite tracks.

### Easy call management

The call controller offers access to large buttons and easy-to-see LED indicators. Answer or end calls, control the volume, or simply mute the call.

### Passive noise cancellation

Simply wear the headset to eliminate high-frequency noise, such as human voices - all thanks to the specially designed ear cushions. We call this “passive noise cancellation”.

# What's in the box

---

 **NOTE:** The documents shipped with the headset may vary based on your region.

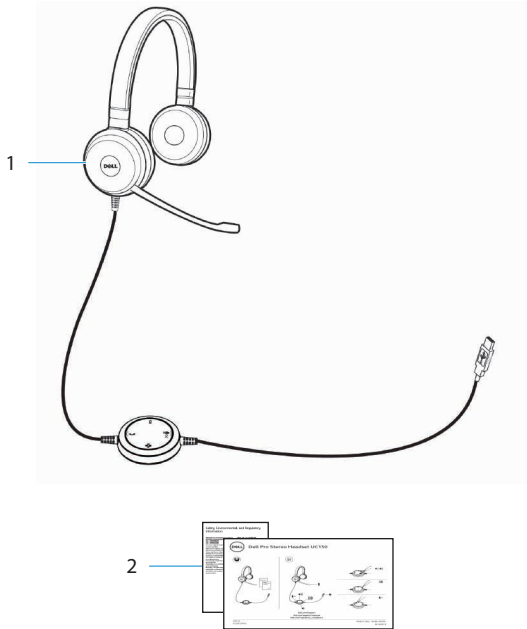

1 Headset

2 Documents

---

# Features

---

## Headset

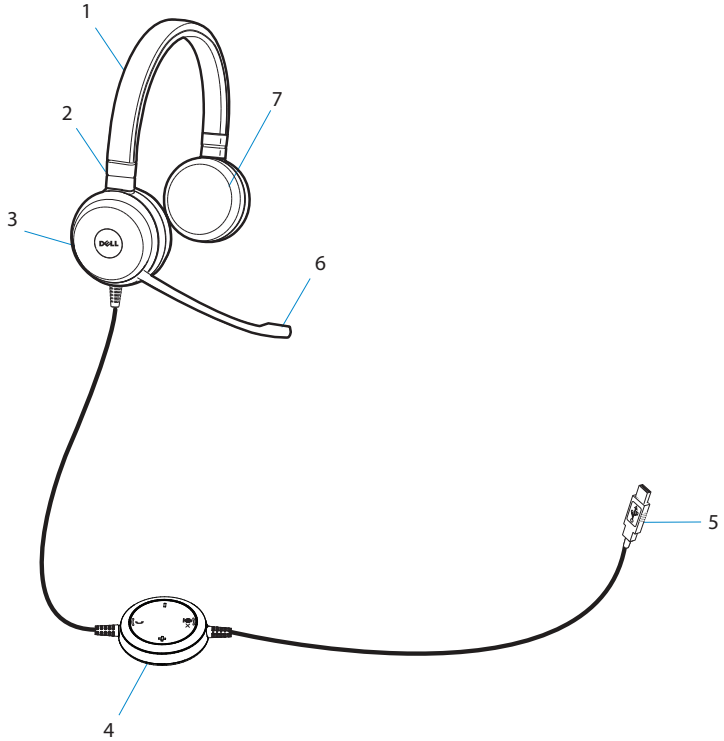

1	Headband	2	Adjustable speaker chambers
3	Speaker	4	Call control unit
5	USB plug	6	Noise cancelling microphone
7	Speaker		

---

# Call-control unit

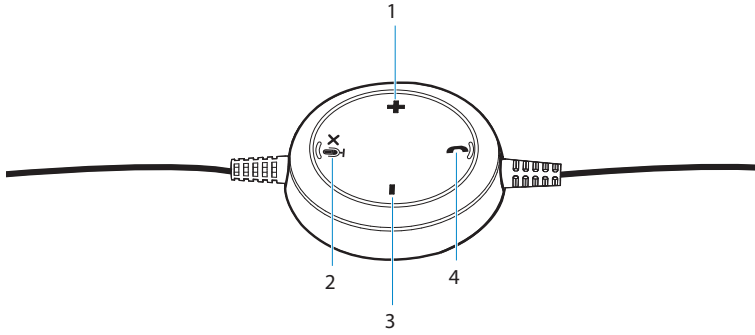

1	Volume up button	2	Mute button
3	Volume down button	4	Phone button



# Setting up your headset

---

## Plug the headset into your computer

Plug the headset into a USB port on your computer.

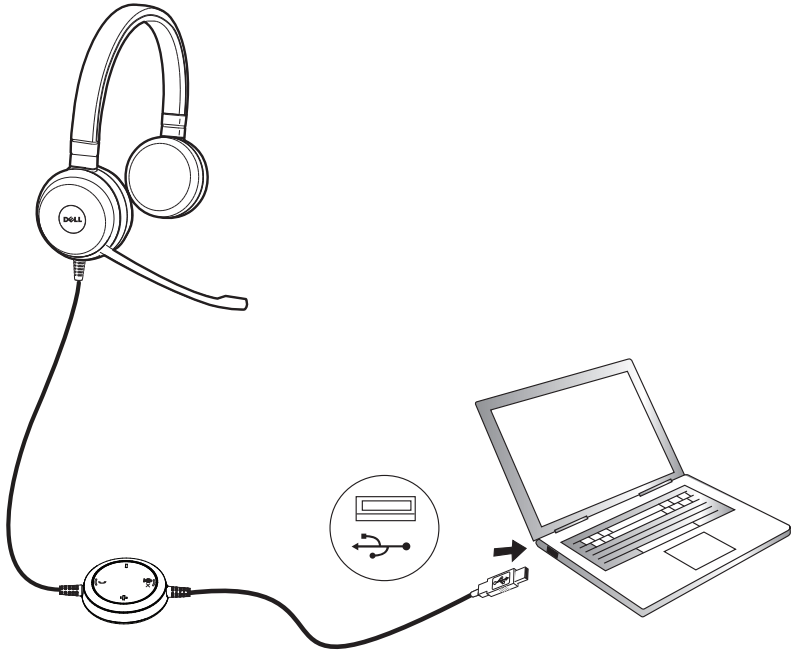

## **Configure the headset on your computer**

### **Configuration for Skype for Business**

The Dell Pro Stereo Headset UC150 is certified and optimized for Skype for Business. Connect your headset to your device via USB. Once the headset is detected, it is ready to use.

### **Configuration for other softphones**

The Dell Pro Stereo Headset UC150 is also certified and optimized for all leading Unified Communications platforms. First, you have to install the Jabra Direct software application on your computer to be able to use the call-control unit functionalities.

1. Connect the headset to your computer via USB.
2. Download the latest release of Jabra Direct at [www.jabra.com/direct](http://www.jabra.com/direct) and follow the installation guide at [www.dell.com/support](http://www.dell.com/support).
3. Once completed, the headset is ready to use.

## Configuration to listen to music

To use your headset to listen to music from your computer, select the headset as the default playback device in Windows Audio Settings.

1. Right click on the speaker icon on the Windows toolbar to access the Windows Audio Settings.

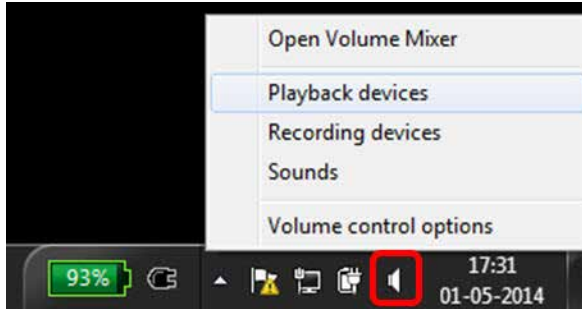

2. Set the Headset Earphone (Dell Pro Stereo Headset UC150) as the Default Playback Device.

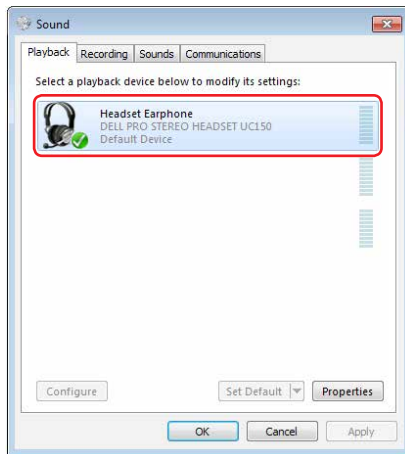

## Adjusting the headset

Adjust the headband to get the optimal fit for your headset. Adjust the headset boom arm to have the microphone around 2 centimeters (cm) away from the mouth.

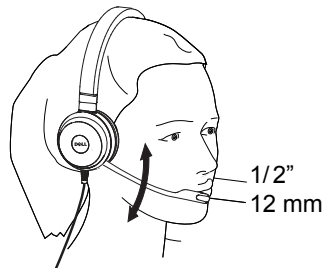
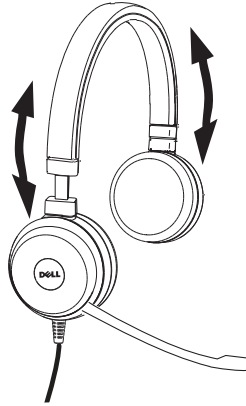

## Answering/ending a call

Answer an incoming call on the computer

You will hear a ringtone on the headset on an incoming call from the soft phone. Answer the call by doing one of the following:

1. Accept the call on the softphone.
2. Press the Phone button on the headset as shown below.

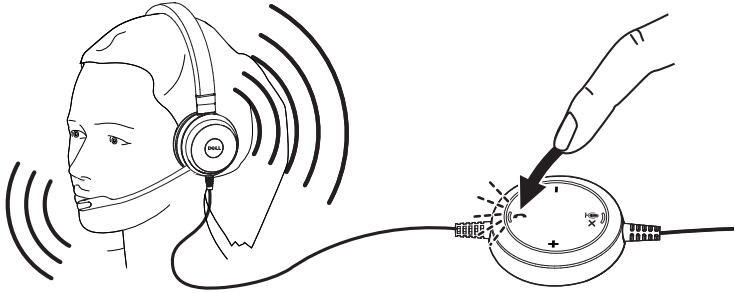

## End an incoming call on the computer

Perform one of the following actions to terminate the call:

1. Press the end-call button on your Softphone.
2. Press the Phone button on the headset as shown below.

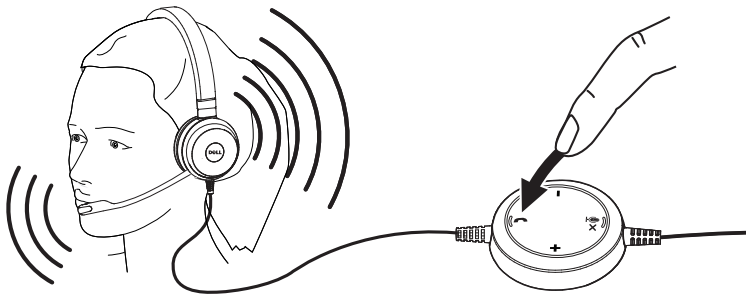

## Adjusting the volume

Use the + and – button located at the center of the call control unit to adjust the volume. Press + to increase the volume level and – to decrease the volume as shown below.

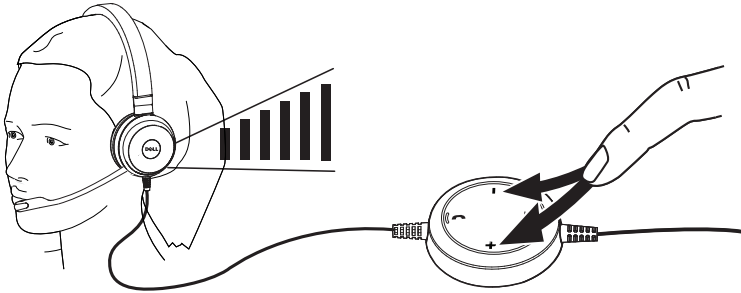

## Muting/unmuting a call

Press the mute button to mute and unmute the microphone as shown below. Whenever the microphone is muted, a red LED glows indicating that the microphone is muted, and whenever the microphone is unmuted, the red LED stops.

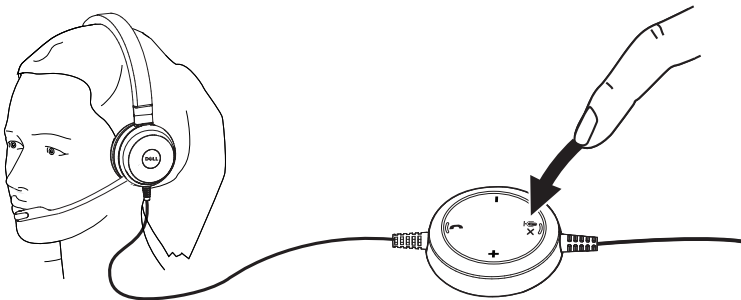

# Troubleshooting

---

## Common symptoms

The following table contains general information about common Dell Pro Stereo Headset UC150 symptoms you might encounter and the possible solutions.

<b>Common symptoms</b>	<b>What you experience</b>	<b>Possible solutions</b>
Headset does not power up when connected to the computer	The red and green LEDs on the call-control unit are not glowing after connection	<ul style="list-style-type: none"><li>• Make sure that the computer is powered up.</li><li>• Make sure that the headset is plugged into the computer through a USB port.</li><li>• Try using another USB port.</li><li>• Try plugging the headset directly into one of the computer's USB ports and NOT into a USB hub.</li><li>• Try using the headset on another computer.</li></ul>
Computer cannot detect the headset	Cannot be detected by the computer	<ul style="list-style-type: none"><li>• Make sure that the computer is powered up.</li><li>• Make sure that the headset is plugged into the computer through a USB port.</li><li>• Make sure that the USB port is not disabled.</li><li>• Try using another USB port.</li><li>• Try plugging the headset directly into one of the computer's USB ports and NOT into a USB hub.</li><li>• Try using the headset on another computer.</li><li>• Make sure that no settings in Windows or other applications such as firewall, anti-virus and security programs etc. prevent connectivity with the USB interface.</li></ul>

---



---

No audio in the headset –Using with Softphone on a computer

Cannot hear sound in the headset from softphone

- Make sure that the headset is connected properly and powered up.
- Make sure that the speaker volume is appropriately set on the headset.
- Make sure that the speaker is not muted on the softphone and volume is set to the appropriate level.
- Make sure that the caller has not muted his/her microphone.
- Make sure that the audio is routed to the headset from the softphone and verify the audio settings on the softphone.
- Make sure that the headset is correctly set up in Windows audio settings.
- Make sure that no settings in Windows or other applications such as firewall, anti-virus and security programs etc., prevent connectivity with the USB interface.

---

No audio in the headset –Using a media player on a computer

Cannot hear sound in the headset from a media player

- Make sure that the headset is connected to the computer and is powered up.
- Make sure that the speaker volume on the headset is set to an appropriate level.
- Make sure that the speaker on the media player is not muted and volume is set to an appropriate level.
- Make sure that the headset is correctly set up in Windows audio settings.

---

Audio not clear in headset	The sound is not clear	<ul style="list-style-type: none"> <li>• Make sure that the speaker volume is set to an appropriate level on the Windows, softphone and media player audio settings.</li> <li>• Make sure that the person on the other end has set the transmit volume to the appropriate level.</li> <li>• Make sure that the person on the other end, if using a headset, has positioned his/her microphone properly (close enough to the mouth - approximately 2 cm/less than 1 inch).</li> </ul>
----------------------------	------------------------	--

---

No microphone audio from headset – Using softphone on a computer	Person on the other end cannot hear you	<ul style="list-style-type: none"> <li>• Make sure that the headset is connected properly and powered up.</li> <li>• Make sure that the microphone is not muted, and the transmit volume is set to the appropriate level, both on the softphone and headset.</li> <li>• Make sure that audio is routed to the headset (Dell Pro Stereo Headset UC150) from the softphone and verify the audio settings on the softphone.</li> <li>• Make sure that the headset is correctly set up in Windows audio settings.</li> <li>• Make sure that the caller has not muted his/her speaker and that it is set to an appropriate level.</li> </ul>
--	---	---

---

<p>No microphone audio from headset – Using voice/recording application on a computer</p>	<p>Microphone does not work using voice/recording application</p>	<ul style="list-style-type: none"> <li>• Make sure that the headset is connected to the computer and is powered up.</li> <li>• Make sure that the microphone on the headset is not muted.</li> <li>• Make sure that the headset is correctly set up in Windows audio settings as shown in the link <a href="#">Audio settings for Windows</a>.</li> </ul>
<p>Microphone audio not clear from headset</p>	<p>Person on the other end cannot hear you clearly</p>	<ul style="list-style-type: none"> <li>• Make sure that the microphone volume is set to the appropriate level in the softphone audio settings.</li> <li>• Make sure that the microphone volume is set to the appropriate level in the Windows audio settings.</li> <li>• Make sure that the microphone is close enough to the mouth - approximately 2 cm/less than 1 inch.</li> <li>• Make sure that the person on the other end has set the speaker (receive) volume on computer / desk phone and headset to the appropriate level.</li> </ul>
<p>Cannot pause Windows Media Player while on an incoming/outgoing call</p>	<p>Music from Windows Media Player does not stop when you take a call</p>	<ul style="list-style-type: none"> <li>• Make sure that the Jabra PC Suite is installed on the computer. Download the latest release of Jabra PC Suite and follow the installation guide at the following link <a href="http://www.jabra.com/direct">www.jabra.com/direct</a>.</li> <li>• Open the application Jabra Device Service and select the Preferences tab.</li> <li>• Make sure that Pause Windows Media Player when a call is initiated is selected.</li> </ul>

# Specifications

---

## General

Model number	UC150
USB compliance	USB 2.0 (General and Audio Class specifications)
LED	Green for in use, red for mute
Supported operating systems	Windows 7 (32 and or 64 bit), Windows 8 and Windows 8.1, Windows 10

## Physical characteristics

Weight	171 g without packaging
Dimension	Headset 181 mm x 151 mm x 54 mm Controller 54 mm x 14.5 mm
Cord length	PC to USB 0.95 m, USB to headset 1.2 m
Washable item	None (general cleaning with damp cloth)

## Environmental

Operating temperature	+10° to +40° C
Operating humidity	5% to 93% relative humidity
Storage temperature	0° to +60° C

# Statutory information

---

## Warranty

Limited warranty and return policies

Dell-branded products carry a 1-year limited hardware warranty. If purchased together with a Dell system, it will follow the system warranty.

### For U.S. customers:

This purchase and your use of this product are subject to Dell's end user agreement, which you can find at [www.dell.com/terms](http://www.dell.com/terms). This document contains a binding arbitration clause.

### For European, Middle Eastern and African customers:

Dell-branded products that are sold and used are subject to applicable national consumer legal rights, the terms of any retailer sale agreement that you have entered into (which will apply between you and the retailer) and Dell's end user contract terms.

Dell may also provide an additional hardware warranty – full details of the Dell end user contract and warranty terms can be found by going to [www.dell.com](http://www.dell.com), selecting your country from the list at the bottom of the “home” page and then clicking the “terms and conditions” link for the end user terms or the “support” link for the warranty terms.

### For non-U.S. customers:

Dell-branded products that are sold and used are subject to applicable national consumer legal rights, the terms of any retailer sale agreement that you have entered into (which will apply between you and the retailer) and Dell's warranty terms. Dell may also provide an additional hardware warranty – full details of Dell's warranty terms can be found by going to [www.dell.com](http://www.dell.com), selecting your country from the list at the bottom of the “home” page and then clicking the “terms and conditions” link or the “support” link for the warranty terms.