

RIG 400 Series

RIG 400, RIG 400HS, RIG 400HX, RIG
400LX

User Guide

Contents

Setup and basics	3
Assemble headset	3
Be safe	3
Setup PS4	3
Setup Xbox One	4
Adjust the volume	4
Mute	4
LX1 adapter guide for LX series	5
Overview	5
Set up	5
Support	7

Setup and basics

Assemble headset

Your headset components easily snap into the headset frame to configure the best fit and sound.

- 1 Follow the diagram to put your headset together.
IMPORTANT When inserting the boom, align the notches on the boom jack and port. The microphone will not work if the boom is inserted incorrectly.

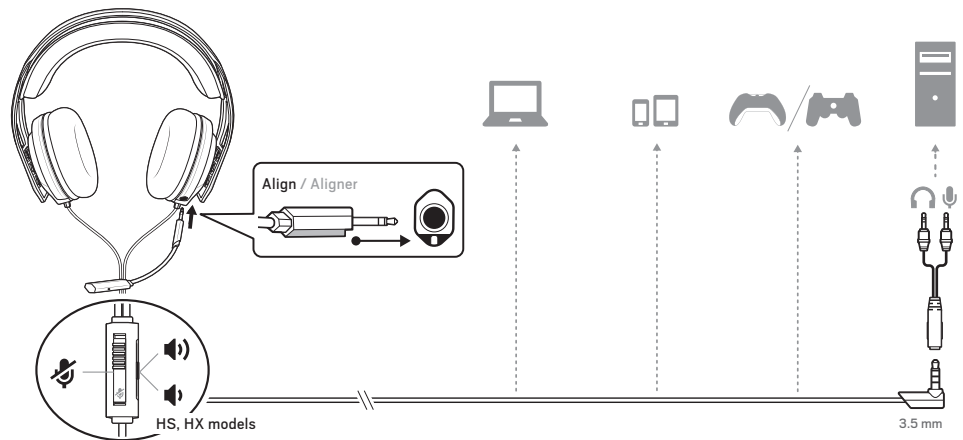

NOTE Laptop, tablet and mobile device compatibility and use with these devices is not tested nor endorsed by Sony Interactive Entertainment Europe.

- 2 The headband adjusts to three sizes (small, medium, large) by moving the earcups. To remove an earcup, press the earcup to detach it from the headband.

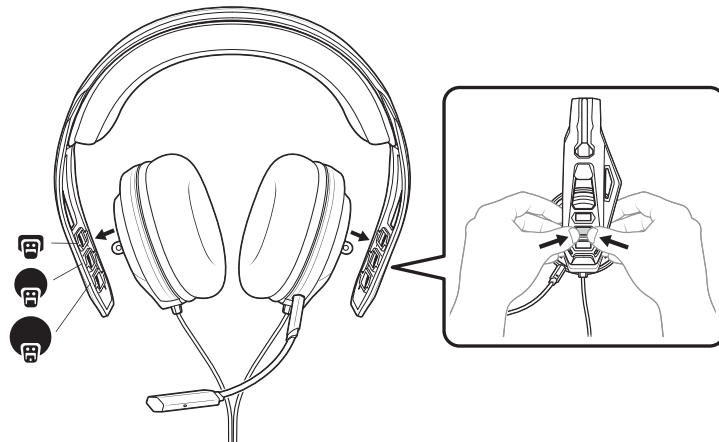

Be safe

Please read the safety guide for important safety, charging, battery and regulatory information before using your new headset.

Setup PS4

- 1 To setup your headset for PS4, first go to **Settings > Devices > Audio Devices > Output to Headphones > All Audio**
- 2 For system volume control, go to **Settings > Devices > Audio Devices > Output to headphones > Volume Control**

Setup Xbox One

To setup your headset for Xbox One, go to **Display and sound > Kinect and devices > Select device and adjust settings**

Adjust the volume

(HS, HX models) To adjust the volume, slide the volume control.

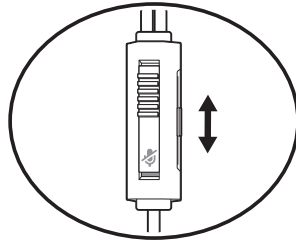

Mute

(HS, HX models) To mute your headset, slide the mute switch to reveal the red color.

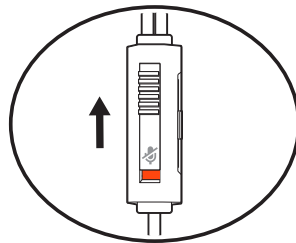

LX1 adapter guide for LX series

Overview

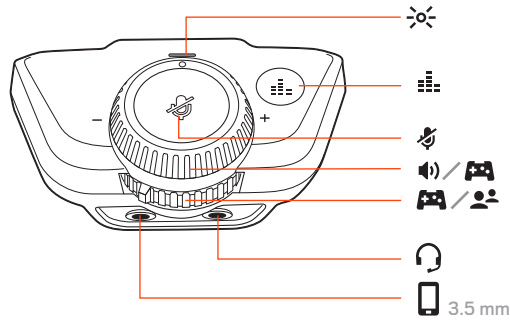



 **LED**
Red = Mute
Blue = Balanced mode
Green = Independent mode

 **EQ settings (short press)**
Single tone = Pure EQ maintains high frequencies
Double tone = Intensify EQ emphasizes mid-range sounds
Triple tone = Seismic EQ boosts bass

Mode settings (press and hold for 4 seconds)
Balance mode = The top dial controls master volume and the bottom dial controls game and chat volume
Independent mode = The top dial controls game volume and the bottom dial controls chat volume

 Tap to mute your mic (LED turns red)

 **Top dial**
Balance mode = Controls master volume
Independent mode = Controls game volume

 **Bottom dial**
Balance mode = Balances game and chat volume
Independent mode = Controls chat volume

 Headset port

 3.5mm stereo AUX input

NOTE *Balance mode is the default setting.*

Set up

The adapter is compatible with the Xbox One first and second generation wireless controllers.

- 1 Plug the adapter into a compatible Xbox One controller.
- 2 Power on the Xbox One controller. It may take the adapter up to 10 seconds to boot up. The LED turns on for 2 seconds to indicate power.

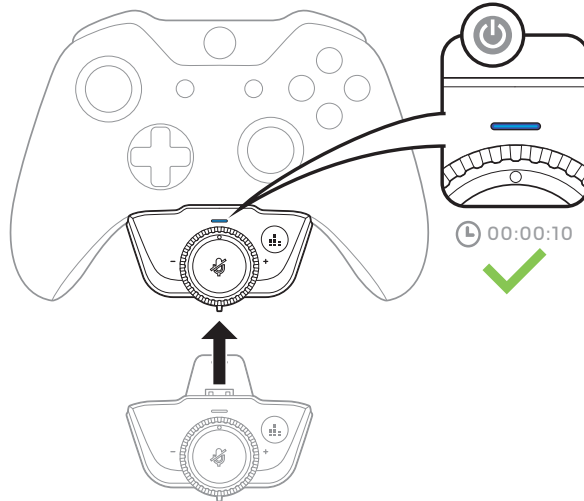

- 3 Connect a headset to the adapter in the 3.5 mm jack.
- 4 Choose how you want the dials to be configured. By default, the adapter is set to Balance mode. Press the EQ button for 2 seconds to switch between Balance and Independent mode.
 - **Balance mode** In Balance mode (blue LED) the top dial controls master volume and the bottom dial balances game and chat.



- **Independent mode** In Independent (green LED) mode the game and chat channels are split; the top dial controls game volume and the bottom dial controls chat volume.

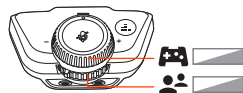

- 5 Choose an EQ setting. Cycle through the EQ modes by tapping the EQ button.

Tap the EQ button and hear	EQ mode
one tone	Pure EQ maintains high frequencies.
two tones	Intensify EQ emphasizes mid-range sounds.
three tones	Seismic EQ boosts bass.

- 6 **Optional** Plug a device into the 3.5 mm jack, if you want to listen music while gaming.

Support

EN 0800 410014	FI 0800 117095	NO 80011336
AR +44 (0)1793 842443*	FR 0800 945770	PL +44 (0)1793 842443*
CS +44 (0)1793 842443*	GA 1800 551 896	PT 800 84 45 17
DA 80 88 46 10	HE +44 (0)1793 842443*	RO +44 (0)1793 842443*
DE Deutschland 0800 9323 400 Österreich 0800 242 500 Schweiz 0800 932 340	HU +44 (0)1793 842443*	RU 8-800-100-64-14 +44 (0)1793 842443*
EL +44 (0)1793 842443*	IT 800 950934	SV 0200 21 46 81
ES 900 803 666	NL NL 0800 7526876 BE 0800 39202 LUX 800 24870	TR +44 (0)1793 842443*

**Support in English*

For warranty details, go to plantronics.com/warranty.

NEED MORE HELP?

plantronics.com/support

plantronics®
Simply Smarter Communications™

Plantronics, Inc.
345 Encinal Street
Santa Cruz, CA 95060
United States

Plantronics B.V.
Scorpius 171
2132 LR Hoofddorp
Netherlands

© 2017 Plantronics, Inc. Plantronics and RIG are trademarks of Plantronics, Inc. registered in the US and other countries. "PlayStation" and "DUALSHOCK" are registered trademarks of Sony Interactive Entertainment Inc. All rights reserved. All other trademarks are the property of their respective owners.

Patents: EM 002814079; patents pending.

207795-06 (11.17)