

Brilliance
BDM3270QP



www.philips.com/welcome

EN	User manual	1
	Customer care and warranty	40
	Troubleshooting & FAQs	45

PHILIPS

Table of Contents

1. Important	1
1.1 Safety precautions and maintenance	1
1.2 Notational Descriptions	2
1.3 Disposal of product and packing material	3
2. Setting up the monitor	4
2.1 Installation	4
2.2 Operating the monitor	6
2.3 MultiView	9
2.4 Remove the Base Assembly for VESA Mounting	12
2.5 MHL (Mobile High-Definition Link) introduction	13
3. Image Optimization	14
3.1 SmartImage	14
3.2 SmartContrast	15
3.3 Philips SmartControl Premium	15
3.4 SmartDesktop Guide	23
4. Technical Specifications	28
4.1 Resolution & Preset Modes	31
4.2 Crystalclear	31
5. Power Management	32
6. Regulatory Information	33
7. Customer care and warranty	40
7.1 Philips' Flat Panel Monitors Pixel Defect Policy	40
7.2 Customer Care & Warranty	42
8. Troubleshooting & FAQs	45
8.1 Troubleshooting	45
8.2 SmartControl Premium FAQs	46
8.3 General FAQs	47
8.4 Multiview FAQs	49

1. Important

This electronic user's guide is intended for anyone who uses the Philips monitor. Take time to read this user manual before you use your monitor. It contains important information and notes regarding operating your monitor.

The Philips guarantee applies provided the product is handled properly for its intended use, in accordance with its operating instructions and upon presentation of the original invoice or cash receipt, indicating the date of purchase, dealer's name and model and production number of the product.

1.1 Safety precautions and maintenance

Warnings

Use of controls, adjustments or procedures other than those specified in this documentation may result in exposure to shock, electrical hazards and/or mechanical hazards.

Read and follow these instructions when connecting and using your computer monitor.

Operation

- Please Keep the monitor out of direct sunlight, very strong bright lights and away from any other heat source. Lengthy exposure to this type of environment may result in discoloration and damage to the monitor.
- Remove any object that could fall into ventilation holes or prevent proper cooling of the monitor's electronics.
- Do not block the ventilation holes on the cabinet.
- When positioning the monitor, make sure the power plug and outlet are easily accessible.
- If turning off the monitor by detaching the power cable or DC power cord, wait for 6 seconds before attaching the power cable or DC power cord for normal operation.

- Please use approved power cord provided by Philips all the time. If your power cord is missing, please contact with your local service center. (Please refer to Customer Care Consumer Information Center)
- Do not subject the monitor to severe vibration or high impact conditions during operation.
- Do not knock or drop the monitor during operation or transportation.

Maintenance

- To protect your monitor from possible damage, do not put excessive pressure on the LCD panel. When moving your monitor, grasp the frame to lift; do not lift the monitor by placing your hand or fingers on the LCD panel.
- Unplug the monitor if you are not going to use it for an extensive period of time.
- Unplug the monitor if you need to clean it with a slightly damp cloth. The screen may be wiped with a dry cloth when the power is off. However, never use organic solvent, such as, alcohol, or ammonia-based liquids to clean your monitor.
- To avoid the risk of shock or permanent damage to the set, do not expose the monitor to dust, rain, water, or excessive moisture environment.
- If your monitor gets wet, wipe it with dry cloth as soon as possible.
- If foreign substance or water gets in your monitor, please turn the power off immediately and disconnect the power cord. Then, remove the foreign substance or water, and send it to the maintenance center.
- Do not store or use the monitor in locations exposed to heat, direct sunlight or extreme cold.
- In order to maintain the best performance of your monitor and use it for a longer lifetime, please use the monitor in a location that falls within the following temperature and humidity ranges.

1. Important

- Temperature: 0-40°C 32-95°F
- Humidity: 20-80% RH

Important information for Burn-in/Ghost image

- Always activate a moving screen saver program when you leave your monitor unattended. Always activate a periodic screen refresh application if your monitor will display unchanging static content. Uninterrupted display of still or static images over an extended period may cause “burn in”, also known as “after-imaging” or “ghost imaging”, on your screen.
- “Burn-in”, “after-imaging”, or “ghost imaging” is a well-known phenomenon in LCD panel technology. In most cases, the “burned in” or “after-imaging” or “ghost imaging” will disappear gradually over a period of time after the power has been switched off.

Warning

Failure to activate a screen saver, or a periodic screen refresh application may result in severe “burn-in” or “after-image” or “ghost image” symptoms that will not disappear and cannot be repaired. The damage mentioned above is not covered under your warranty.

Service

- The casing cover should be opened only by qualified service personnel.
- If there is any need for any document for repair or integration, please contact with your local service center. (please refer to the chapter of “Consumer Information Center”)
- For transportation information, please refer to “Technical Specifications”.
- Do not leave your monitor in a car/trunk under direct sun light.

Note

Consult a service technician if the monitor does not operate normally, or you are not sure what procedure to take when the operating instructions given in this manual have been followed.

1.2 Notational Descriptions

The following subsections describe notational conventions used in this document.

Notes, Cautions and Warnings

Throughout this guide, blocks of text may be accompanied by an icon and printed in bold or italic type. These blocks contain notes, cautions or warnings. They are used as follows:

Note

This icon indicates important information and tips that help you make better use of your computer system.

Caution

This icon indicates information that tells you how to avoid either potential damage to hardware or loss of data.

Warning

This icon indicates the potential for bodily harm and tells you how to avoid the problem.

Some warnings may appear in alternate formats and may not be accompanied by an icon. In such cases, the specific presentation of the warning is mandated by the relevant regulatory authority.

1.3 Disposal of product and packing material

Waste Electrical and Electronic Equipment- WEEE



This marking on the product or on its packaging illustrates that, under European Directive 2012/19/EU governing used electrical and electronic appliances, this product may not be disposed of with normal household waste. You are responsible for disposal of this equipment through a designated waste electrical and electronic equipment collection. To determine the locations for dropping off such waste electrical and electronic, contact your local government office, the waste disposal organization that serves your household or the store at which you purchased the product.

Your new monitor contains materials that can be recycled and reused. Specialized companies can recycle your product to increase the amount of reusable materials and to minimize the amount to be disposed of.

All redundant packing material has been omitted. We have done our utmost to make the packaging easily separable into mono materials.

Please find out about the local regulations on how to dispose of your old monitor and packing from your sales representative.

Taking back/Recycling Information for Customers

Philips establishes technically and economically viable objectives to optimize the environmental performance of the organization's product, service and activities.

From the planning, design and production stages, Philips emphasizes the important of

making products that can easily be recycled. At Philips, end-of-life management primarily entails participation in national take-back initiatives and recycling programs whenever possible, preferably in cooperation with competitors, which recycle all materials (products and related packaging material) in accordance with all Environmental Laws and taking back program with the contractor company.

Your display is manufactured with high quality materials and components which can be recycled and reused.

To learn more about our recycling program please visit

<http://www.philips.com/sites/philipsglobal/about/sustainability/ourenvironment/productrecyclingservices.page>

2. Setting up the monitor

2.1 Installation

1 Package contents

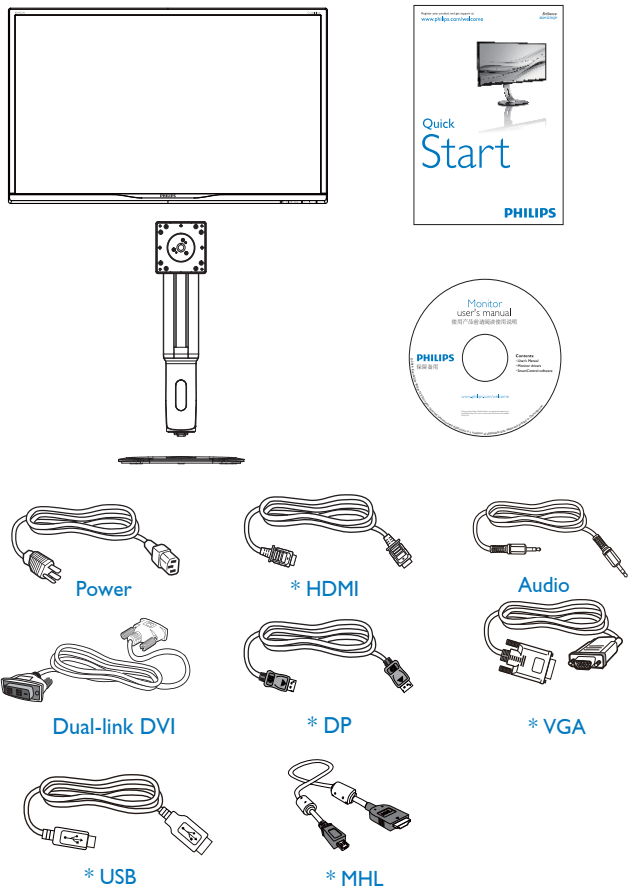

*Depends on the country

2 Install the base

1. Place the monitor face down on a smooth surface. Pay attention not to scratch or damage the screen.

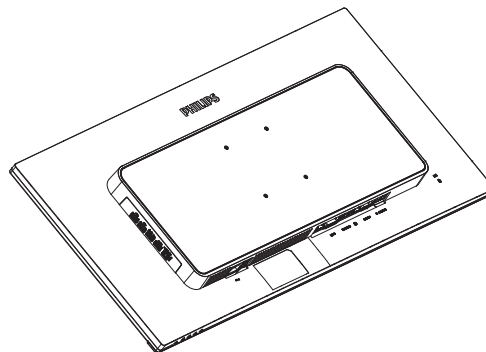

2. Hold the neck with both hands.
 - (1) Gently attach the neck to the VESA mount area until the latch locks the neck.
 - (2) Use a screwdriver to tighten the assembly screws, and secure the neck to the monitor tightly.
 - (3) Use your fingers to tighten the screw located at the bottom of the base, and secure the base to the stand tightly.

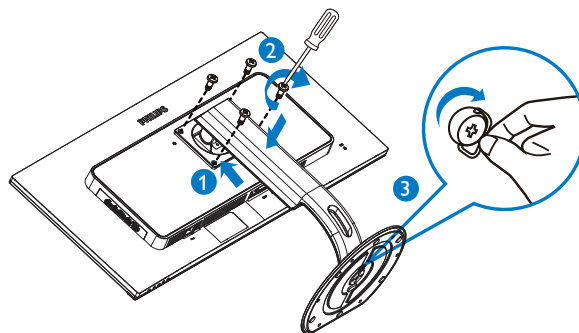

2. Setting up the monitor

3 Connecting to your PC

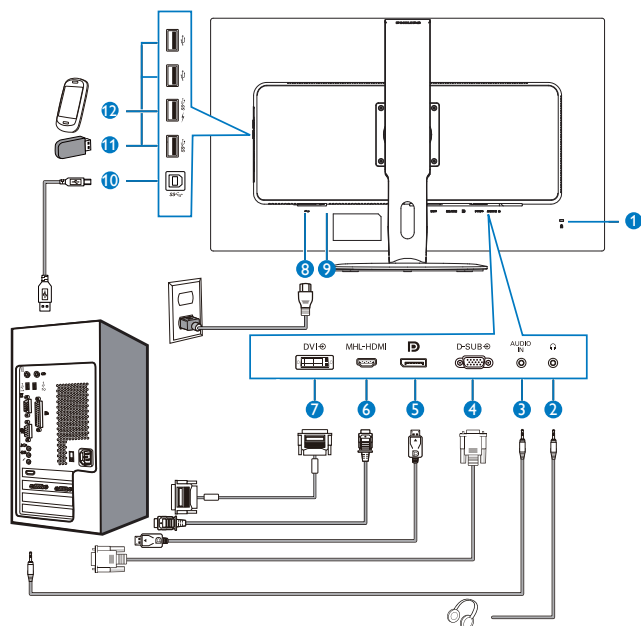

- 1 Kensington anti-theft lock
- 2 Earphone jack
- 3 Audio input
- 4 VGA input
- 5 Display port input
- 6 MHL-HDMI input
- 7 DVI input
- 8 AC power input
- 9 Power Switch
- 10 USB upstream
- 11 USB downstream
- 12 USB fast charger

Connect to PC

1. Connect the power cord to the back of the monitor firmly.
2. Turn off your computer and unplug its power cable.
3. Connect the monitor signal cable to the video connector on the back of your computer.
4. Plug the power cord of your computer and your monitor into a nearby outlet.
5. Turn on your computer and monitor. If the monitor displays an image, installation is complete.

2.2 Operating the monitor

1 Description of the control buttons

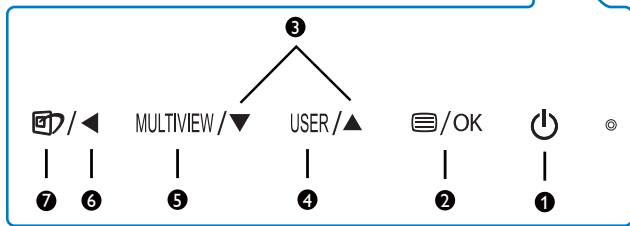
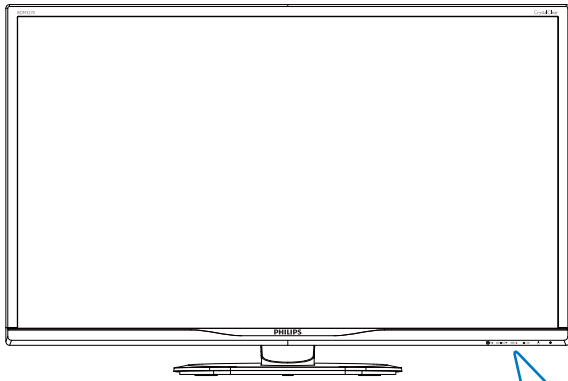

1		Switch monitor's power ON or OFF.
2		Access the OSD menu. Confirm the OSD adjustment.
3		Adjust the OSD menu.
4	USER	User preference key. Customize your own preference function from OSD to become the "user key".
5	MULTIVIEW	PIP/PBP/Off/Swap
6		Return to previous OSD level.
7		SmartImage hot key. There are 7 modes to select: Office, Photo, Movie, Game, Economy, SmartUniformity, Off.

2 Customize your own "USER" key

This hot key allows you to setup your favorite function key.

1. Press button on the front bezel to enter OSD Menu Screen.

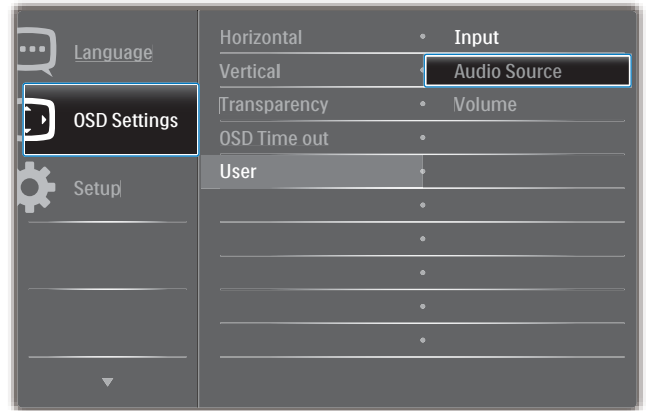

2. Press or button to select main menu [OSD Settings], then press **OK** button.
3. Press or button to select [User], then press **OK** button.
4. Press or button to select your preferred function: [Audio Source], [Volume], or [Input].
5. Press **OK** button to confirm your selection.

Now you can press the hotkey directly on the front bezel. Only your pre-selected function will appear for quick access.

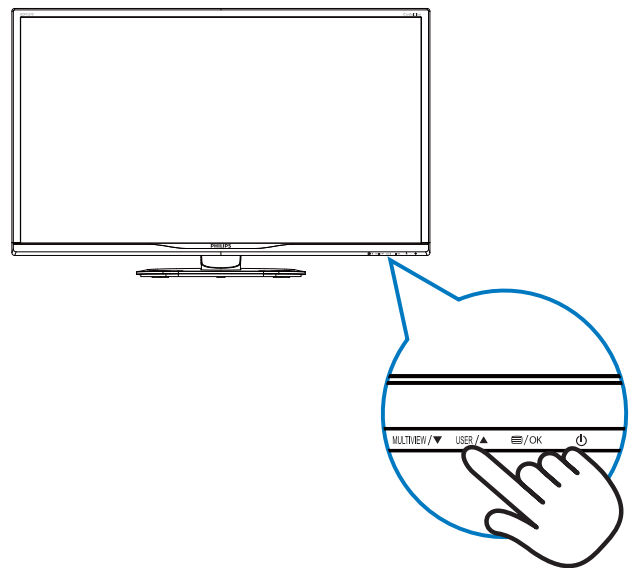

For example, if you selected [Audio Source] as the hotkey, press the **USER** button on the front bezel, the [Audio Source] menu appears.

2. Setting up the monitor

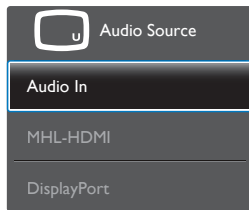





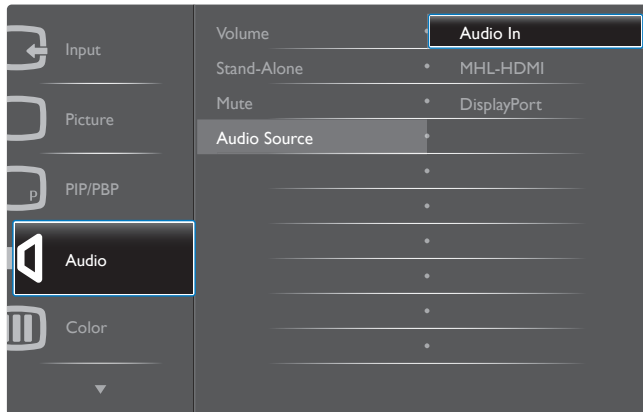

3 Independent audio playback, regardless of video input

Your Philips monitor can play the audio source independently, regardless of which video input. For example, you can play your MP3 player from the audio source connected to the [Audio in] port of this monitor, and still watch your video source connected from [MHL-HDMI], or [DisplayPort].

1. Press  button on the front bezel to enter OSD Menu Screen.



2. Press  or  button to select main menu [Audio], then press **OK** button.
3. Press  or  button to select [Audio Source], then press **OK** button.
4. Press  or  button to select your preferred audio source: [DisplayPort], [MHL-HDMI], or [Audio In].
5. Press **OK** button to confirm your selection.

Note

- The next time you turn on this monitor, it will by default select the audio source you previously selected.
- In case you want to change it, you will have to go through the selection steps again to select your new preferred audio source as the default.



4 Description of the On Screen Display

What is On-Screen Display (OSD)?

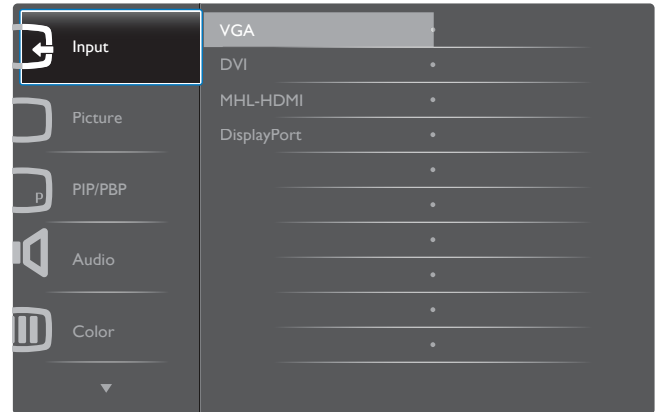
On-Screen Display (OSD) is a feature in all Philips LCD monitors. It allows an end user to adjust screen performance or select functions of the monitors directly through an on-screen instruction window. A user friendly on screen display interface is shown as below:



Basic and simple instruction on the control keys

In the OSD shown above, you can press   buttons at the front bezel of the monitor to move the cursor, and press **OK** button to confirm the choice or change.

2. Setting up the monitor

The OSD Menu

Below is an overall view of the structure of the On-Screen Display. You can use this as a reference when you want to work your way around the different adjustments later on.

Main menu	Sub menu	
Input	VGA	
	DVI	
	MHL-HDMI DisplayPort	
Picture	Picture Format	Wide screen, 4:3, 1:1
	Brightness	0~100
	Contrast	0~100
	Sharpness	0~100
	SmartResponse	Off, Fast, Faster, Fastest
	SmartContrast	On, Off
	Gamma	1.8, 2.0, 2.2, 2.4, 2.6
	Pixel Orbiting	On, Off
	Over Scan	On, Off
	PIP/PBP	PIP/PBP Mode
PIP/PBP Input		VGA, DVI, MHL-HDMI, DisplayPort
PIP Size		Small, Middle, Large
PIP Position		Top-Right, Top-Left, Bottom-Right, Bottom-Left
Swap		
Audio	Volume	0~100
	Stand-Alone	On, Off
	Mute	On, Off
	Audio Source	Audio in, MHL-HDMI, DisplayPort
Color	Color Temperature	5000K, 6500K, 7500K, 8200K, 9300K, 11500K
	sRGB	
	User Define	Red: 0~100 Green: 0~100 Blue: 0~100
Language	English, Deutsch, Español, Ελληνική, Français, Italiano, Magyar, Nederlands, Português, Português do Brasil, Polski, Русский, Svenska, Suomi, Türkçe, Čeština, Українська, 简体中文, 繁體中文, 日本語, 한국어	
OSD Settings	Horizontal	0~100
	Vertical	0~100
	Transparency	Off, 1, 2, 3, 4
	OSD Time Out	5s, 10s, 20s, 30s, 60s
	User	Input, Audio Source, Volume
Setup	Auto	
	H. Position	0~100
	V. Position	0~100
	Phase	0~100
	Clock	0~100
	Resolution Notification	On, Off
	DisplayPort	1.1, 1.2
	Reset	Yes, No
	Information	

5 Resolution notification

This monitor is designed for optimal performance at its native resolution, 2560 x 1440 @ 60 Hz. When the monitor is powered on at a different resolution, an alert is displayed on screen: Use 2560 x 1440 @ 60 Hz for best results.

Display of the native resolution alert can be switched off from Setup in the OSD (On Screen Display) menu.

6 Physical Function

Tilt

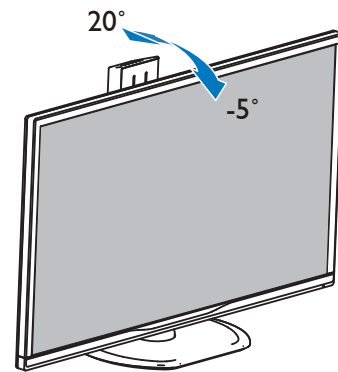

Swivel

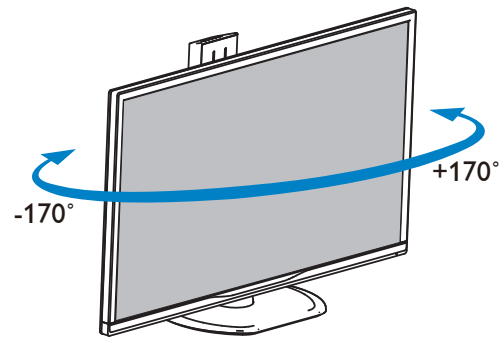

Height adjustment

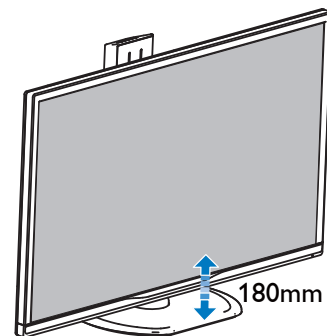

Pivot

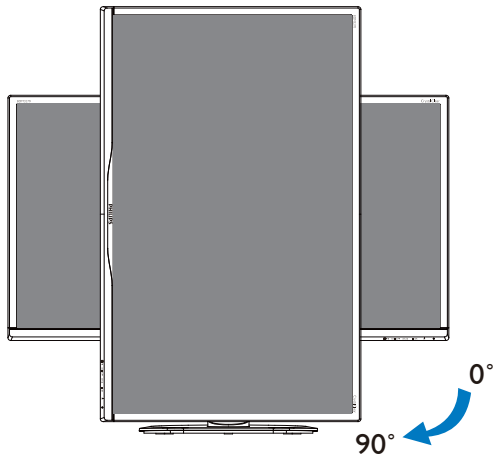

2.3 MultiView



1 What is it?

Multiview enables active dual connect and view so that you can work with multiple devices like PC and Notebook side-by-side simultaneously, making complex multi-tasking work a breeze.

2 Why do I need it?

With the ultra high resolution Philips MultiView display, you can experience a world of connectivity in a comfortable way in the office or at home. With this display, you can conveniently enjoy multiple content sources at one screen. For example: You may want to keep an eye on the live news video feed with audio in the small window, while working on your latest blog, or you may want to edit an Excel file from your Ultrabook, while logged into secured company intranet to access files from a desktop.

2. Setting up the monitor

3 How to enable MultiView by hotkey?

1. Press the hotkey **MULTIVIEW** directly on the front bezel.

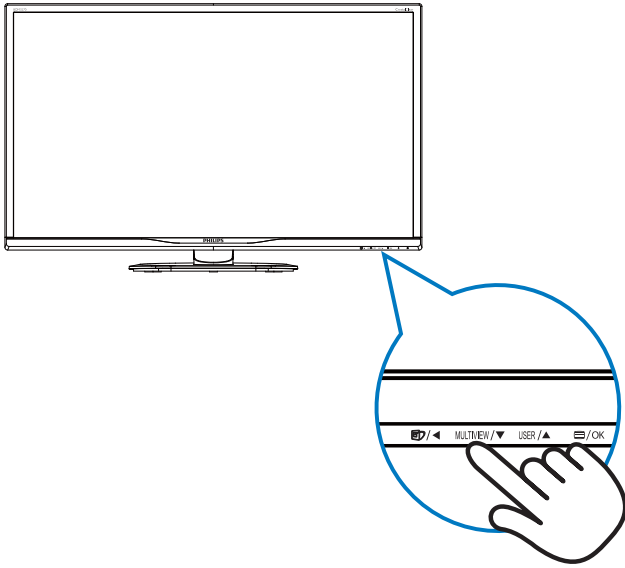

2. The MultiView selection menu appears. Press **▲** or **▼** button to select.

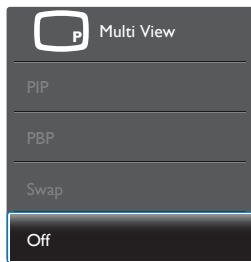

3. Press **OK** button to confirm your selection and then exit automatically.

4 How to enable MultiView by OSD menu?

Besides pressing the hotkey **MULTIVIEW** directly on the front bezel, the MultiView function can also be selected in OSD menu.

1. Press **≡** button on the front bezel to enter OSD Menu Screen.

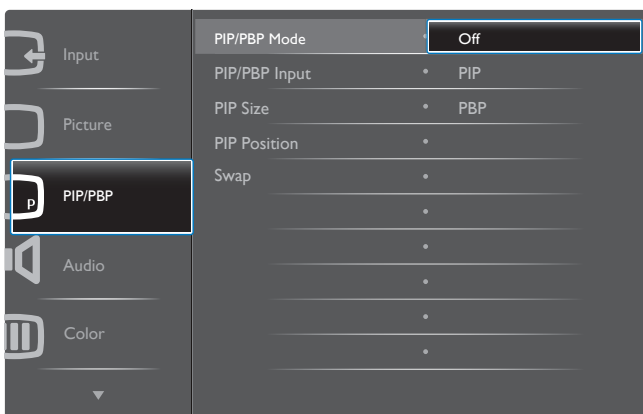

- Press **▲** or **▼** button to select main menu [**PIP / PBP**], then press **OK** button.
 - Press **▲** or **▼** button to select [**PIP / PBP Mode**], then press **OK** button.
 - Press **▲** or **▼** button to select [**PIP**] or [**PBP**].
 - Now you can move backward to set the [**PIP / PBP Input**], [**PIP Size**], [**PIP Position**], or [**Swap**].
2. Press **OK** button to confirm your selection.

5 MultiView in OSD menu

- **PIP / PBP Mode:** There are two modes for MultiView: [**PIP**] and [**PBP**].

[**PIP**]: Picture in Picture

Open up a sub-window of another signal source.

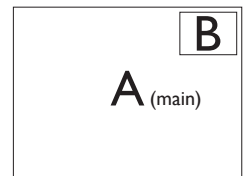

When the sub source is not detected:

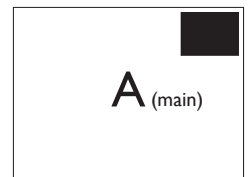

[**PBP**]: Picture by Picture

Open up a sub-window side-by-side of another signal source.

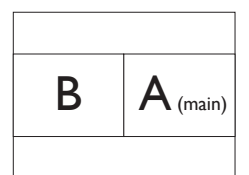

When the sub source is not detected:

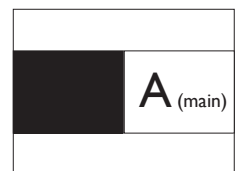

Note

The black strip shows on the top and the bottom of the screen for the correct aspect ratio when in the PBP mode.

2. Setting up the monitor

- **PIP / PBP Input:** There are four different video input to choose as the sub display source: [DVI], [MHL-HDMI], and [DisplayPort].

Please refer below table for compatibility of main/sub input source.

MultiView		SUB SOURCE POSSIBILITY (x1)			
		Inputs	VGA	DP	DVI
MAIN SOURCE (x1)	VGA		•	•	•
	DP	•		•	•
	DVI	•	•		•
	MHL-HDMI	•	•	•	

- **PIP Size:** When PIP is activated, there are three sub-window sizes to choose: [Small], [Middle], [Large].

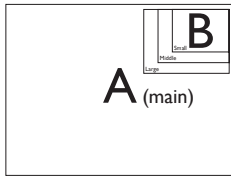

- **PIP Position:** When PIP is activated, there are two sub-window positions to choose.

Top-Right

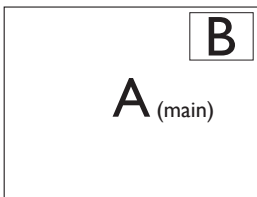

Bottom-Right

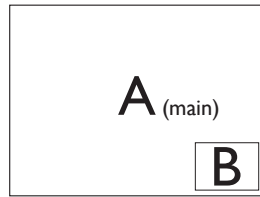

- **Swap:** The main picture source and the sub picture source swapped on the display.

Swap A and B source in [PIP] mode:

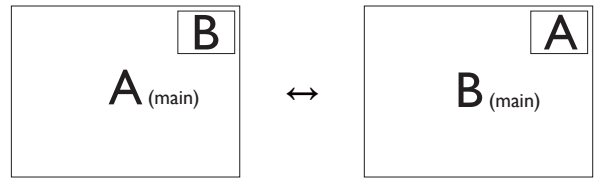

Swap A and B source in [PBP] mode:

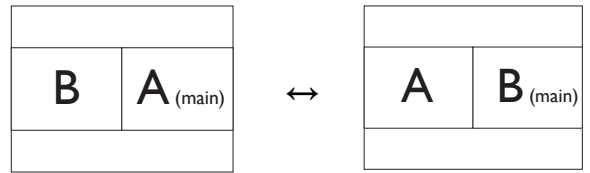

- **Off:** Stop MultiView function.

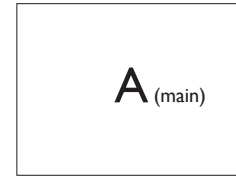

Note

- When you do the SWAP function, the video and its audio source will swap at the same time. (Refer to page 7 "Independent audio playback, regardless of video input" for more detail.)

2.4 Remove the Base Assembly for VESA Mounting

Before you start disassembling the monitor base, please follow the instructions below to avoid any possible damage or injury.

1. Place the monitor face down on a smooth surface. Pay attention not to scratch or damage the screen.

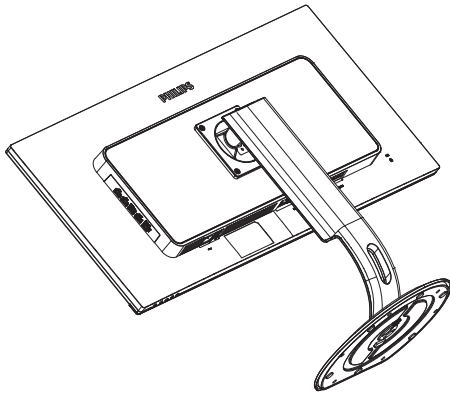

2. Loosen the assembly screws, then detach the neck from the monitor.

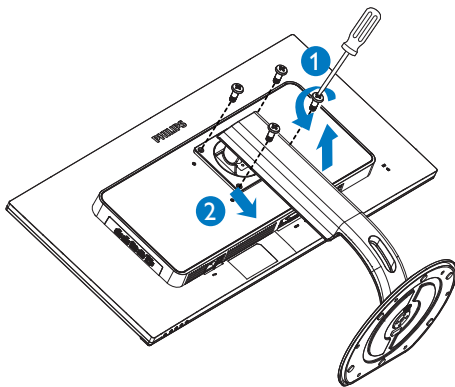

Note

This monitor accepts a 100mm x 100mm VESA-Compliant mounting interface.

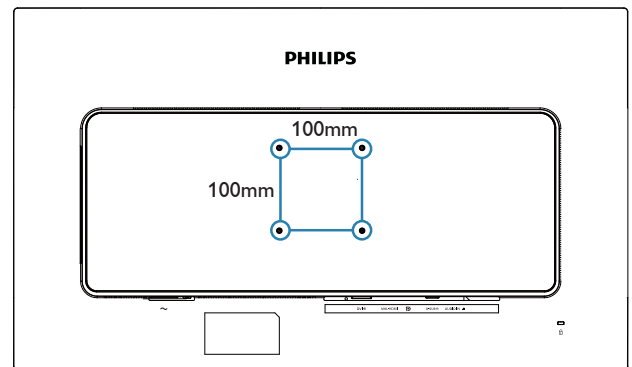

2.5 MHL (Mobile High-Definition Link) introduction

1 What is it?

Mobile High Definition Link (MHL) is a mobile audio/video interface for directly connecting mobile phones and other portable devices to high-definition displays.

An optional MHL cable allows you to simply connect your MHL capable mobile device to this large Philips MHL display, and watch your HD videos come to life with full digital sound. Now not only you can enjoy your mobile games, photos, movies, or other apps on its big screen, you can simultaneously charge your mobile device so you never run out of power half way.

2 How do I use the MHL function?

To use the MHL function, you need an MHL-Certified mobile device. To find a list of MHL-certified devices, visit the official MHL website (<http://www.mhlconsortium.org>)

You also need a optional MHL certified special cable in order to use this function.

3 How does it work? (how do I connect?)

Connect the Optional MHL cable to the mini USB port on the mobile device side, and the [MHL-HDMI] marked port on the monitor side. You are now ready to view the images on your big screen display and operate all function on you the mobile device such as internet surfing, game playing, photo browsing...etc. if your monitor has speaker function, then you will be able to hear accompanying sound too. When the MHL cable is disconnected or the mobile device is turned off, the MHL function will be automatically disabled.

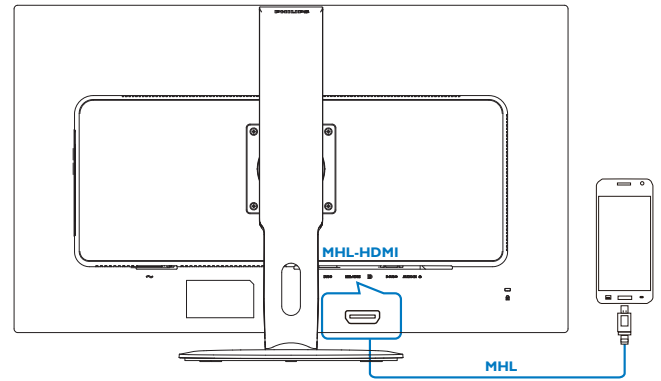

Note

- The port marked [MHL-HDMI] is the only port on the monitor that supports the MHL function when the MHL cable is used. Note that the MHL certified cable is different than a standard HDMI cable.
- A mobile device with MHL certification must be purchased separately
- You may have to manually switch the monitor to MHL-HDMI mode in order to activate the monitor, if you have other devices already working and connected to available inputs
- Standby/Off energy saving of ErP is not applicable for the MHL charging functionality
- This Philips display is MHL certified. However, in case your MHL device does not connect or work correctly, check with your MHL device FAQ or vendor directly for direction. The policy of your device manufacturer may require you to purchase their brand specific MHL cable or adapter in order to work with other brand MHL devices. Note that this is not a fault of this Philips display.

3. Image Optimization

3.1 SmartImage

1 What is it?

SmartImage provides presets that optimize display for different types of content, dynamically adjusting brightness, contrast, color and sharpness in real time. Whether you're working with text applications, displaying images or watching a video, Philips SmartImage delivers great optimized monitor performance.

2 Why do I need it?



You want a monitor that delivers optimized display all your favorite types of content, SmartImage software dynamically adjust brightness, contrast, color and sharpness in real time to enhance your monitor viewing experience.

3 How does it work?

SmartImage is an exclusive, leading edge Philips technology that analyzes the content displayed on your screen. Based on a scenario you select, SmartImage dynamically enhances the contrast, color saturation and sharpness of images to enhance the contents being displayed - all in real time with the press of a single button.

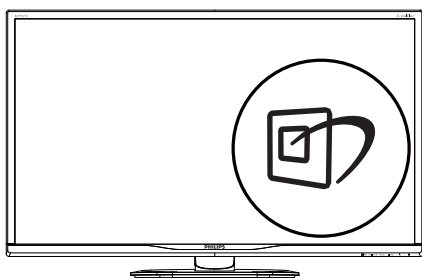
4 How to enable SmartImage?



1. Press  to launch the SmartImage on screen display.
2. Keep pressing   to toggle among Office, Photo, Movie, Game, Economy, SmartUniformity and Off.

3. The SmartImage on screen display will remain on screen for 5 seconds, or you can also press "OK" to make confirmation.

There are seven modes to select: Office, Photo, Movie, Game, Economy, SmartUniformity and Off.

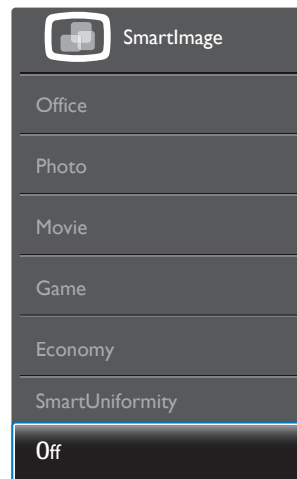

- **Office:** Enhances text and dampens brightness to increase readability and reduce eye strain. This mode significantly enhances readability and productivity when you're working with spreadsheets, PDF files, scanned articles or other general office applications.
- **Photo:** This profile combines color saturation, dynamic contrast and sharpness enhancement to display photos and other images with outstanding clarity in vibrant colors - all without artifacts and faded colors.
- **Movie:** Ramped up luminance, deepened color saturation, dynamic contrast and razor sharpness displays every details in darker areas of your videos without color washout in brighter areas maintaining a dynamic natural values for the ultimate video display.
- **Game:** Turn on over drive circuit for best response time, reduce jaggy edges for fast moving objects on screen, enhance contrast ratio for bright and dark scheme, this profile delivers the best gaming experience for gamers.

3. Image Optimization

- **Economy:** Under this profile, brightness, contrast are adjusted and backlighting finetuned for just right display of everyday office applications and lower power consumption.
- **SmartUniformity:** Fluctuations in brightness and color on different parts of a screen are a common phenomenon among LCD monitors. Typical uniformity is measured around 75-80%. By enabling Philips SmartUniformity feature, display uniformity is increased to above 95%. This produces more consistent and true images.
- **Off:** No optimization by SmartImage.

3.2 SmartContrast

1 What is it?

Unique technology that dynamically analyzes displayed content and automatically optimizes a Monitor's contrast ratio for maximum visual clarity and viewing enjoyment, stepping up backlighting for clearer, crisper and brighter images or dimming backlighting for clear display of images on dark backgrounds.

2 Why do I need it?

You want the very best visual clarity and viewing comfort for every type of content. SmartContrast dynamically controls contrast and adjusts backlighting for clear, crisp, bright gaming and video images or displays clear, readable text for office work. By reducing your monitor's power consumption, you save on energy costs and extend the lifetime of your monitor.

3 How does it work?

When you activate SmartContrast, it will analyse the content you are displaying in real time to adjust colors and control backlight intensity. This function will dynamically enhance contrast for a great entertainment experience when viewing videos or playing games.

3.3 Philips SmartControl Premium

The new SmartControl Premium software by Philips allows you to control your monitor via an easy to use on-screen graphic interface. Complicated adjustments are a thing of the past as this user friendly software guides you through fine-tuning resolution, Color calibration, Clock/Phase adjustments, RGB White point adjustment, etc.

Equipped with latest technology in core algorithm for fast processing and response, this Windows compliant eye catching animated Icon based software is ready to enhance your experience with Philips monitors!

1 Installation

- Follow the instruction and complete the installation.
- You can launch after installation is completed.
- If you want to launch later, you can either click the shortcut on desktop or toolbar.

PHILIPS



First launch -Wizard

- The first time after installation of SmartControl Premium, it will automatically go to Wizard for first time launch.
- The wizard will guide you through adjustment your monitor performance step by step.
- You can go to Plug-in menu to launch wizard later on as well.

3. Image Optimization

- You can adjust more options without wizard by Standard pane.



2 Start with Standard pane

Adjust menu

- Adjust Menu allows you to adjust Brightness, Contrast, and Resolution.
- You can follow the instruction and do the adjustment.
- Cancel prompts user if you want to cancel installation.

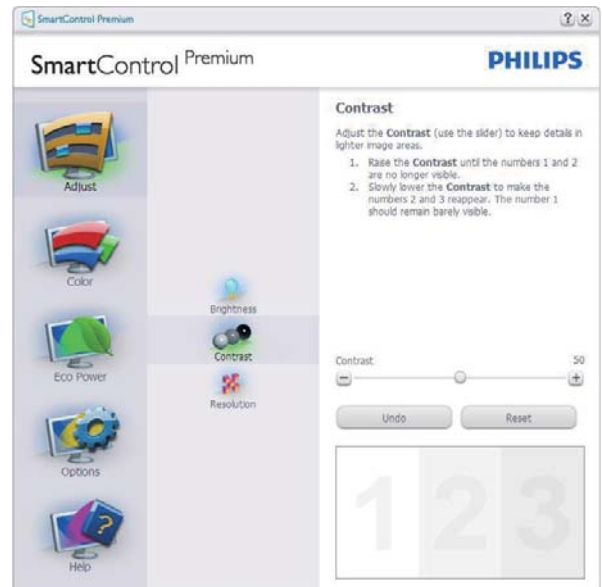

Color menu

- Color Menu allows you to adjust RGB, Black Level, White Point, Display Gamma, Calibration, SmartImage, and SmartKolor.
- You can follow the instruction and do the adjustment.
- Refer to below table for sub-menu item base on your input.
- Example for Color Calibration.

3. Image Optimization

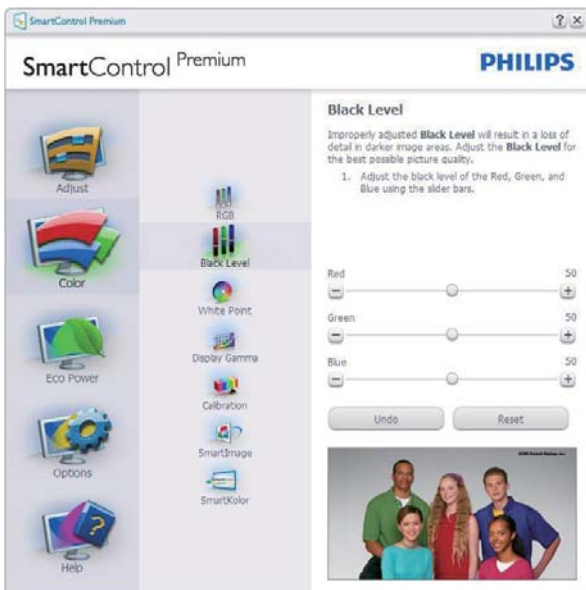

1. "Show Me" starts color calibration tutorial.
2. Start - starts the 6-step color calibration sequence.
3. Quick View loads the before/after images.
4. To return to Color home pane, click the **Cancel** button.
5. Enable color calibration - by default is on. If unchecked, does not allow for color calibration to happen, dimes out start and quick view buttons.
6. Must have patent info in calibration screen.

3. Image Optimization

First Color Calibration Screen



- Previous button is disabled until the second color screen.
- Next goes to the succeeding target (6-targets).
- Final next goes File > Presets pane.
- Cancel closes the UI and returns to the plug in page.

SmartImage

Allow users to change setting for better display setting based on content.

When Entertainment is set, SmartContrast and SmartResponse are enabled.



Eco Power menu



Options menu

Options>Preferences - Will only be active when selecting Preferences from the drop-down Options menu. On a non-supported display capable of DDC/CI, only the Help and Options tabs are available.



- Displays current preference settings.
- A checked box enables the feature. The check box is a toggle.
- Enable Context Menu on desktop is checked (On) by default. Enable Context menu displays SmartControl Premium selections for Select Preset and Tune Display in the desktop right-click context

3. Image Optimization

menu. Disabled removes SmartControl Premium from the right click context menu.

- Enable Task Tray icon is checked (On) by default. Enable context menu shows the task tray menu for SmartControl Premium. A right click on the task tray icon displays the menu options for Help, Technical Support, Check for Update, About, and Exit. When Enable task tray menu is disabled, the task tray icon will only display Exit.
- Run at Startup is checked (On) by default. When disabled, SmartControl Premium will not launch at start or be in the task tray. The only way to launch SmartControl Premium is either from the desktop short cut or from the program file. Any preset set to run at startup will not load when this box is unchecked (Disabled).
- Enable transparency mode (Windows 7, Windows 8, Vista, XP). Default is 0% Opaque.

Options>Audio - Will only be active when selecting Volume from the drop-down Options menu.

On a non-supported display capable of DDC/CI, only the Help and Options tabs are available.



Option>Auto Pivot.



Options>Input - Will only be active when selecting Input from the drop-down Options menu. On a non-supported display capable of DDC/CI, only the Help and Options tabs are available. All other SmartControl Premium tabs are not available.



- Display the Source instruction pane and current input source setting.
- On single input displays, this pane will not be visible.

3. Image Optimization

Options>Theft Deterrence - Theft Deterrence Pane will only be active when selecting Theft Deterrence Mode from the drop-down Plug-in menu.



To enable Theft Deterrence, click on **On** button to bring up the following screen:

- User can enter PIN between 4 and 9 digits numbers only.
- After entering PIN, Accept button takes user to the pop-up dialog box on the following page.
- Minimum minutes set to 5. Slider set to 5 by default.
- Does not require the display be attached to a different host to go into Theft Deterrence mode.

After creating PIN, the Theft Deterrence pane will indicate Theft Deterrence Enabled and provide PIN Options button:

- Theft Deterrence Enabled is displayed.
- Disable Theft Deterrence Mode opens pane screen on next page.
- PIN Options button only available after user creates PIN, button opens secure PIN web site.

Options>MultiView - Allow users to view content from multiple sources when in PIP and PBP mode.

- Click the red button to select a MultiView mode.



- PIP mode

Select Size, Location, Input, and Audio.



3. Image Optimization



- PBP mode Select Input and Audio.

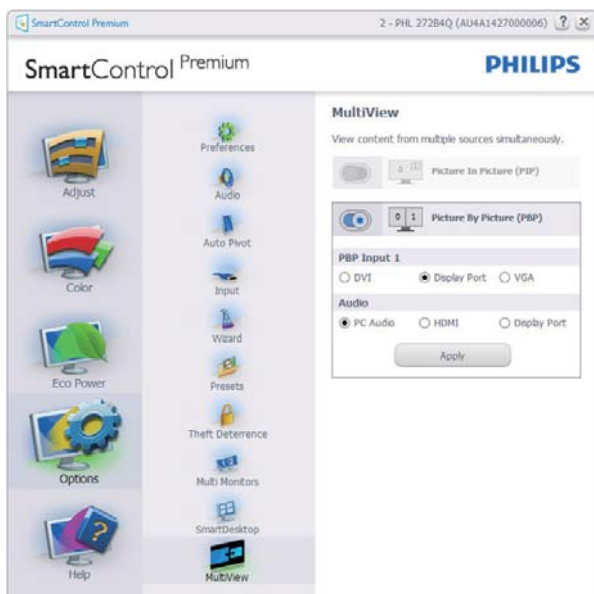
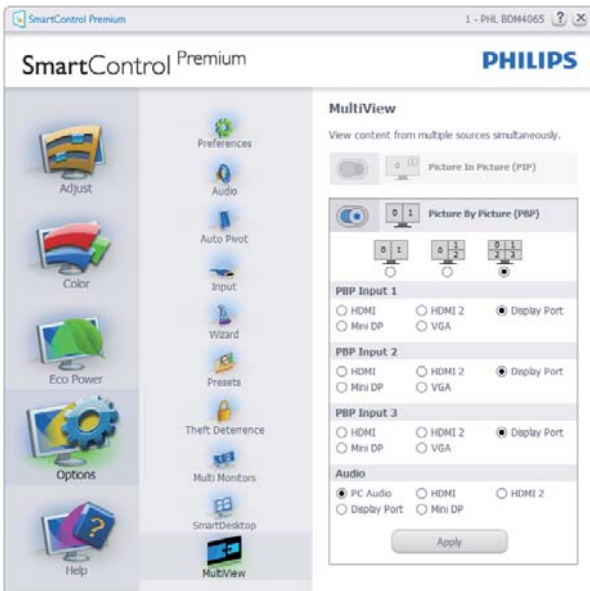

Help menu

Help>User Manual - Will only be active when selecting User Manual from the drop-down Help menu. On a non-supported display capable of DDC/CI, only the Help and Options tabs are available.



Help>Version - Will only be active when selecting Version from the drop-down Help menu. On a non-supported display capable of DDC/CI, only the Help and Options tabs are available.



Context Sensitive menu

The Context Sensitive menu is Enabled by default. If Enable Context Menu has been

3. Image Optimization

checked in the Options>Preferences pane, then the menu will be visible.

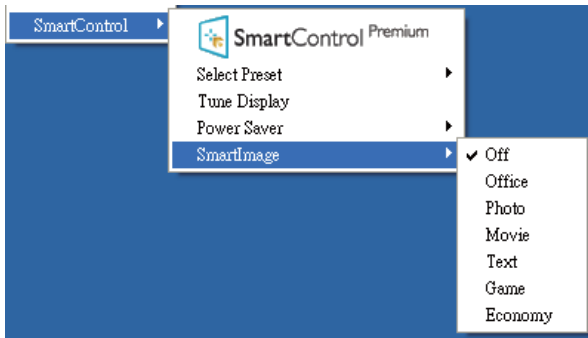

The Context Menu has four entries:

- **SmartControl Premium** - When selected the About screen is displayed.
- **Select Preset** - Provides a hierarchical menu of saved presets for immediate use. A check mark shows the currently selected preset. Factory Preset can also be called from the drop-down menu.
- **Tune Display** - Opens the SmartControl Premium control panel.
- **SmartImage** - Check current settings: Off, Office, Photo, Movie, Game, Economy.

Task Tray Menu Enabled

The task tray menu can be displayed by right-clicking on the SmartControl Premium icon from the task tray. Left Click will launch the application.



The task tray has five entries:

- **Help** - Access to User Manual file: Open User Manual file using the default browser window.
- **Technical Support** - Displays the tech support page.
- **Check for Update** - Takes the user to PDI Landing and checks the user's version against the most current available.
- **About** - Displays detailed reference information: product version, release information, and product name.
- **Exit** - Close SmartControl Premium.

To run SmartControl Premium again, either select SmartControl Premium from Program menu, double-click the desktop PC icon, or restart the system.



Task Tray Menu Disabled

When the Task Tray is disabled in the preference folder, only the Exit selection is available. To completely remove SmartControl Premium from the task tray, disable Run at Startup in Options>Preferences.

Note

All the illustrations in this section are for reference only. SmartControl software version might be changed without notification. Please always check official Portrait website www.portrait.com/dtune/phl/enu/index to download the latest version of SmartControl software.

3.4 SmartDesktop Guide

1 SmartDesktop

SmartDesktop is in SmartControl Premium. Install SmartControl Premium and select SmartDesktop from Options.

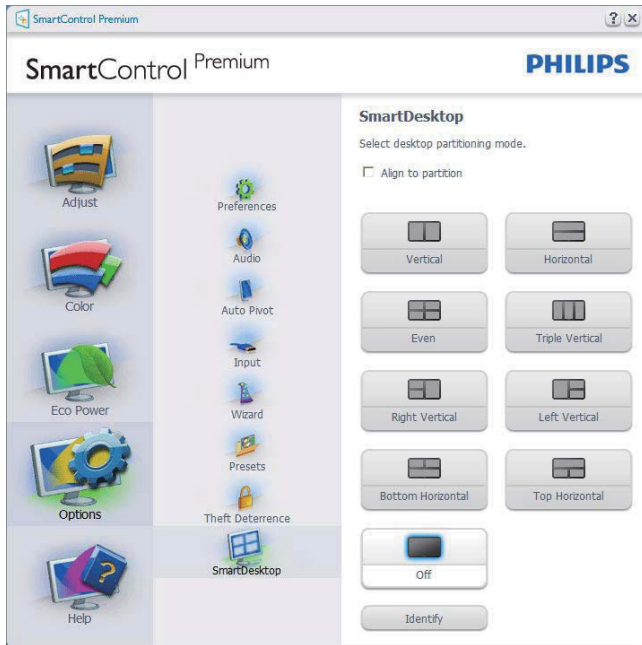

- Align to partition check box will enable automatic alignment for the window when dragged into the defined partition.
- Select the desired partition by clicking on the icon. The partition will be applied to the desktop and the icon will be highlighted.
- Identify provides a quick way to view the grid.

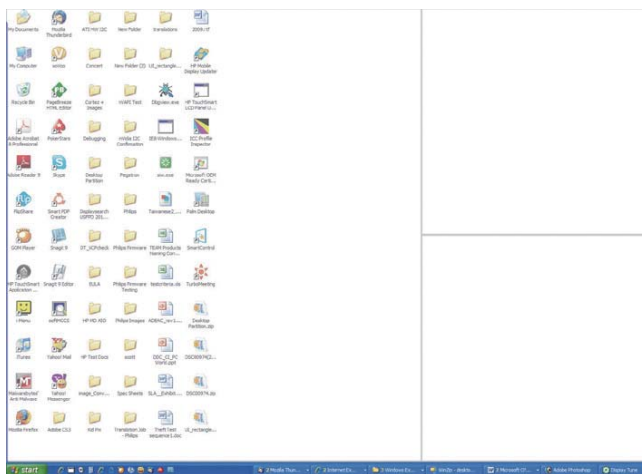

2 Drag and Drop Windows

Once the partitions are configured and Align to partition is selected a window can be dragged into the region and it will automatically align. When the window and mouse cursor are within the region, the region will become highlighted.

Note

If the outline of the region is not visible when dragging the window, "Show windows contents while dragging" is disabled. To enable:

1. In Control Panel, click System.
2. Click Advanced system settings (For Vista & Win7, Win8 OS, this is located on the left sidebar)
3. In Performance section, click Settings.
4. In the box, check Show window contents while dragging, and click OK.

Other alternative path:

Vista

Control Panel > Personalization > Window Color and Appearance > Click "Open Classic appearance properties for more color options" > Click "Effects" button > check Show window contents while dragging

XP:

Display Properties>Appearance>Effects...> check Show window contents while dragging

Win 7:

No other alternative path available.

Win 8:

Windows 8 is to right click on the lower left hand corner then select System > Advanced System Settings (Left side bar) > Performance section - Settings > Show Windows contents while dragging.

3 Title Bar Options

Desktop Partition can be accessed from the title bar of the active window. This provides a quick

3. Image Optimization

and easy way to manage the desktop as well as sending any window to any partition without having to drag and drop. Move the cursor into the active window's title bar to access the drop down menu.



4 Right Click Menu

Right click on the Desktop Partition icon to view the drop down menu.

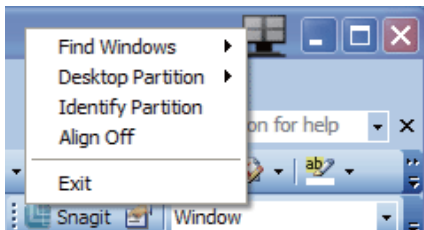

1. Find Windows – In some cases, the user may have sent multiple windows to the same partition. Find Window will show all open windows and move the selected window to the forefront.

2. Desktop Partition – Desktop Partition shows the current selected partition and allows the user to quickly change to any of the partitions shown in the drop down.

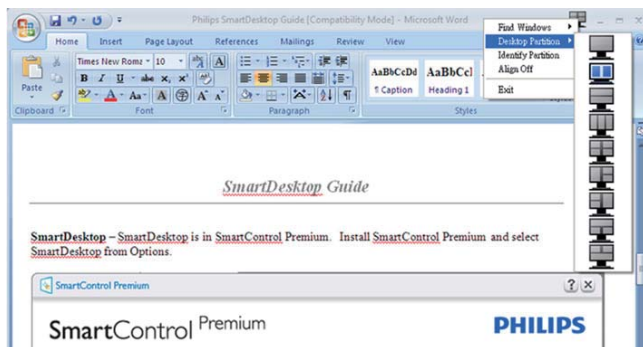

Note

If more than one display is attached, the user can select the targeted display to change the partition. The highlighted icon represents the current active partition.

3. Identify Partition – Displays the outline grid on the desktop for the current partition.

4. Align On/Align Off – Enables/disables the drag and drop auto align feature.

5. Exit – Closes Desktop Partition and Display Tune. To re-initialize, launch Display Tune from the start menu or short cut on the desktop.

5 Left Click Menu

Left click on the Desktop Partition icon to quickly send the active window to any partition without having to drag and drop. Releasing the mouse will send the window to the highlighted partition.

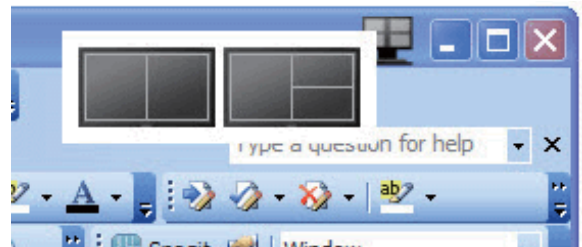





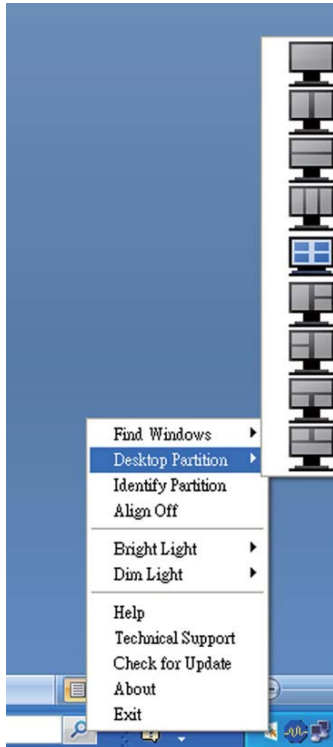

6 Task Tray Right Click

The task tray also contains most of the features supported in the title bar (with the exception of automatically sending a window to any partition).



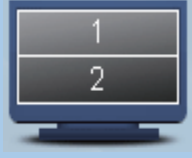

- **Find Windows** – In some cases, the user may have sent multiple windows to the same partition. Find Window will show all open windows and move the selected window to the forefront.
- **Desktop Partition** – Desktop Partition shows the current selected partition and allows the user to quickly change to any of the partitions shown in the drop down.
- **Identify Partition** – Displays the outline grid on the desktop for the current partition.
- **Align On/Align Off** – Enables/disables the drag and drop auto align feature.

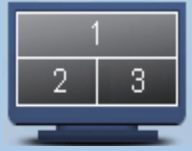
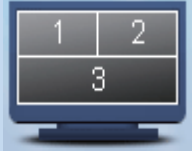

7 SmartDesktop Partition Definitions

Name	Description	Image
Full Desktop	Applies all settings to the entire desktop.	
Vertical	Assesses the screen resolution and divides the display into two evenly sized vertical regions. For 90/270 maintain vertical configuration.	
Horizontal	Assesses the screen resolution and divides the display into two evenly sized horizontal regions. For 90/270 maintain horizontal configuration.	
Vertical Triple	Assesses the screen resolution and divides the display into three evenly sized vertical regions. For 90 Partition 1 horizontal top Partition 2 horizontal center Partition 3 horizontal bottom. For 270 Partition 3 horizontal top Partition 2 horizontal center Partition 1 horizontal bottom.	
Vertical Split Left	Assesses the screen resolution and divides the display into two vertical regions, the left hand side is a single region, the right hand side is split into two evenly sized regions. For 90 Partition 1 on top Partition 2&3 on bottom For 270 Partition 1 on bottom Partition 2&3 on top.	
Vertical Split Right	Assesses the screen resolution and divides the display into two vertical regions, the right hand side is a single region, the left hand side is split into two evenly sized regions. For 90 Partition 1&2 on top Partition 3 on bottom. For 270 Partition 3 on top Partition 1&2 on bottom.	

3. Image Optimization

Name	Description	Image
Horizontal Split Top	<p>Assesses the screen resolution and divides the display into two evenly sized horizontal regions, the top region is single, the bottom region is split into two evenly sized regions</p> <p>For 90 Partition 1 on right side Vertical Partition 2&3 on left side Vertical.</p> <p>For 270 Partition 1 on left side Vertical Partition 2&3 on right side Vertical.</p>	
Horizontal Split Bottom	<p>Assesses the screen resolution and divides the display into two evenly sized horizontal regions, the bottom region is single, the top region is split into two evenly sized regions</p> <p>For 90 Partition 1&2 on right side Vertical Partition 3 on left side Vertical.</p> <p>For 270 Partition 1&2 on left side Vertical Partition 3 on right side Vertical.</p>	
Even Split	<p>Assesses the screen resolution and divides the display into four evenly sized regions.</p>	

4. Technical Specifications

Picture/Display	
Monitor Panel Type	AMVA
Backlight	LED
Panel Size	32" W (81.3 cm)
Aspect Ratio	16:9
Pixel Pitch	0.27675 × 0.27675 mm
Brightness	300 cd/m ²
SmartContrast	50,000,000:1
Contrast Ratio (typ.)	3000:1(Typ)
Response Time	12ms (GtG)
SmartResponse	4ms (GtG)
Optimum Resolution	VGA: 1920 × 1080 @ 60Hz DVI-Dual Link: 2560 × 1440 @ 60Hz HDMI: 2560 × 1440 @ 60Hz DisplayPort: 2560 × 1440 @ 60Hz MHL: 1920 × 1080 @ 60Hz
Viewing Angle	178° (H) / 178° (V) @ C/R > 10 (Typ)
Picture Enhancement	SmartImage
Display Colors	1.07B (10 bits)
Vertical Refresh Rate	56-76Hz (VGA) 50-76Hz (DVI) 23-76Hz (HDMI/MHL/DisplayPort)
Horizontal Frequency	30-99KHz (VGA/DVI) 15-99KHz (HDMI/MHL/DisplayPort)
sRGB	YES
Brightness uniformity	93%-105%
Delta E (typ.)	3 for 6500K
Connectivity	
Signal Input	DVI-Dual Link(Digital),VGA(Analog), DisplayPort, MHL-HDMI
USB	USB3.0x2 (1 for USB fast charger)/USB2.0x2
Input Signal	Separate Sync, Sync on Green
Audio In/Out	PC audio-in,headphone out
Convenience	
Built-in speaker	3 W × 2
Multi View	PIP/PBP mode, 2×devices
User Convenience	 MULTIVIEW / ▼ USER / ▲  /OK 
OSD Languages	English, German, Spanish, Greek, French, Italian, Hungarian, Dutch, Portuguese, Brasil Portuguese, Polish, Russian, Swedish, Finnish, Turkish, Czech, Ukranian, Simplified Chinese, Traditional Chinese, Japanese, Korean
Other Convenience	VESA mount(100×100mm), Kensington Lock
Plug & Play Compatibility	DDC/CI, sRGB, Windows 8.1/8/7/Vista/XP, Mac OSX

4. Technical Specifications

Stand	
Tilt	-5 / +20 degree
Swivel	-170 / +170 degree
Height adjustment	180mm
Pivot	90 degree

Power	
On Mode	70.6W (typ.), 102W (max.)
Sleep (Standby)	<0.5W(typ.)
Off	<0.3W(typ.)
Off (AC switch)	0W(typ.)
On Mode(ECO mode)	31W (typ.)

Power(EnergyStar test method)			
Energy Consumption	AC Input Voltage at 100VAC , 50Hz	AC Input Voltage at 115VAC , 60Hz	AC Input Voltage at 230VAC, 50Hz
Normal Operation	55.06W (typ.)	54.60W (typ.)	53.59W (typ.)
Sleep (Standby)	<0.36W(typ.)	<0.37W (typ.)	<0.46W(typ.)
Off	<0.23W(typ.)	<0.25W(typ.)	<0.30W(typ.)
Off (AC switch)	0W(typ.)	0W(typ.)	0W(typ.)
Heat Dissipation*	AC Input Voltage at 100VAC , 50Hz	AC Input Voltage at 115VAC , 60Hz	AC Input Voltage at 230VAC , 50Hz
Normal Operation	187.92 BTU/hr (typ.)	186.35 BTU/hr (typ.)	182.90 BTU/hr (typ.)
Sleep (Standby)	<1.23 BTU/hr(typ.)	<1.26 BTU/hr(typ.)	<1.57 BTU/hr(typ.)
Off	<0.78 BTU/hr(typ.)	<0.85 BTU/hr(typ.)	<1.02 BTU/hr(typ.)
Off (AC switch)	0 BTU/hr(typ.)	0 BTU/hr(typ.)	0 BTU/hr(typ.)
Power LED indicator	On mode: White, Standby/Sleep mode: White (blinking)		
Power Supply	Built-in, 100-240V AC, 50-60Hz		

Dimensions	
Product with stand (WxHxD)	742 x 657 x 270 mm
Product without stand (WxHxD)	742 x 438 x 61 mm

Weight	
Product with stand	10.76 kg
Product without stand	7.8 kg
Product with packaging	14.98 kg

Operating Condition	
Temperature range (operation)	0°C to 40 °C
Temperature range (Non-operation)	-20°C to 60°C
Relative humidity	20% to 80%

4. Technical Specifications

Environmental and energy	
ROHS	YES
EPEAT	Gold (www.epeat.net)
Packaging	100% recyclable
Specific Substances	100% PVC BFR free housing
EnergyStar	YES
Compliance and standards	
Regulatory Approvals	CE Mark, FCC Class B, SEMKO, cETLus, CU-EAC, TCO Edge, EPA, PSB, WEEE, CCC, CECP, PSE, KC, BSMI, VCCI
Cabinet	
Color	Black
Finish	Texture

Note

1. EPEAT Gold or Silver is valid only where Philips registers the product. Please visit www.epeat.net for registration status in your country.
2. This data is subject to change without notice. Go to www.philips.com/support to download the latest version of leaflet.
3. Smart response time is the optimum value from either GtG or GtG (BW) tests.

4.1 Resolution & Preset Modes

1 Maximum Resolution

1920 × 1080 @ 60 Hz (analog input)

2560 × 1440 @ 60 Hz (digital input)

2 Recommended Resolution

2560 × 1440 @ 60 Hz (digital input)

H. freq (kHz)	Resolution	V. freq (Hz)
31.47	720 × 400	70.09
31.47	640 × 480	59.94
35.00	640 × 480	66.67
37.86	640 × 480	72.81
37.50	640 × 480	75.00
37.88	800 × 600	60.32
46.88	800 × 600	75.00
48.36	1024 × 768	60.00
60.02	1024 × 768	75.03
44.77	1280 × 720	59.86
63.89	1280 × 1024	60.02
79.98	1280 × 1024	75.03
55.94	1440 × 900	59.89
70.64	1440 × 900	74.98
75.00	1600 × 1200	60.00
65.29	1680 × 1050	59.95
67.50	1920 × 1080	60.00
74.04	1920 × 1080	59.95
88.79	2560 × 1440	59.95

Note

- Please notice that your display works best at native resolution of 2560 × 1440 @ 60Hz. For best display quality, please follow this resolution recommendation.
MHL 2.0: 1920X1080@60Hz
- While using DVI, a Dual-link DVI cable is required for maximum resolution 2560 × 1440.

- The highest supporting screen resolution on HDMI is 2560 × 1440, but it always depends on your capability of graphics card and BluRay/video players.

4.2 Crystalclear

This latest Philips display delivers Crystalclear, 2560x1440 images. Utilizing high performance panels with high density pixel count, 178/178 wide viewing angles, enabled by high bandwidth sources like Displayport, HDMI, or Dual link DVI, this new display will make your images and graphics come alive. Whether you are demanding professional requiring extremely detailed information for CAD-CAM solutions, using 3D graphic applications or a financial wizard working on huge spreadsheets, this Philips display will give you Crystalclear images.

5. Power Management

If you have VESA DPM compliance display card or software installed in your PC, the monitor can automatically reduce its power consumption when not in use. If an input from a keyboard, mouse or other input device is detected, the monitor will 'wake up' automatically. The following table shows the power consumption and signaling of this automatic power saving feature:

Power Management Definition					
VESA Mode	Video	H-sync	V-sync	Power Used	LED Color
Active	ON	Yes	Yes	70.6W (typ.) 102W (max.)	White
Sleep (Standby)	OFF	No	No	<0.5W	White (blink)
Switch Off	OFF	-	-	<0.3W	OFF

The following setup is used to measure power consumption on this monitor:

- Native resolution: 2560 × 1440
- Contrast: 50%
- Brightness: 300 nits
- Color temperature: 6500k with full white pattern
- Audio and USB Inactive (Off)

Note

This data is subject to change without notice.

6. Regulatory Information

TCO Edge Certified



**Congratulations,
Your display is designed for both
you and the planet!**

The display you have just purchased carries the TCO Certified Edge label. This ensures that your display is designed, manufactured and tested according to some of the strictest quality and environmental requirements in the world. This makes for a high performance product, designed with the user in focus that also minimizes the impact on the climate and our natural environment.

This display is awarded the TCO Certified cutting edge mark to signify it incorporates a new cutting edge innovation that delivers distinct benefits for the user and reduced impact on the environment. TCO Certified is a third party verified program, where every product model is tested by an accredited impartial test laboratory. TCO Certified represents one of the toughest certifications for displays worldwide.

Some of the Usability features of the TCO Certified for displays:

- Good visual ergonomics and image quality is tested to ensure top performance and reduce sight and strain problems. Important parameters are luminance, contrast, resolution, black level, gamma curve, color and luminance uniformity, color rendition and image stability
- Product have been tested according to rigorous safety standards at an impartial laboratory
- Electric and magnetic fields emissions as low as normal household background levels
- Low acoustic noise emissions

Some of the Environmental features of the TCO Certified for displays:

- The brand owner demonstrates corporate social responsibility and has a certified environmental management system (EMAS or ISO 14001)
- Very low energy consumption both in on and standby mode minimize climate impact
- Restrictions on chlorinated and brominated flame retardants, plasticizers, plastics and heavy metals such as cadmium, mercury and lead (RoHS compliance)
- Both product and product packaging is prepared for recycling
- The brand owner offers take-back options

The requirements can be downloaded from our web site. The requirements included in this label have been developed by TCO Development in co-operation with scientists, experts, users as well as manufacturers all over the world. Since the end of the 1980s TCO has been involved in influencing the development of IT equipment in a more user-friendly direction. Our labeling system started with displays in 1992 and is now requested by users and IT manufacturers all over the world. About 50% of all displays worldwide are TCO certified.

For more information, please visit:
www.tcodevelopment.com

User define mode is used for TCO Certified compliance.

6. Regulatory Information

Lead-free Product



Lead free display promotes environmentally sound recovery and disposal of waste from electrical and electronic equipment. Toxic substances like Lead has been eliminated and compliance with European community's stringent RoHS directive mandating restrictions on hazardous substances in electrical and electronic equipment have been adhered to in order to make Philips monitors safe to use throughout its life cycle.

EPEAT

(www.epeat.net)



The EPEAT (Electronic Product Environmental Assessment Tool) program evaluates computer

desktops, laptops, and monitors based on 51 environmental criteria developed through an extensive stakeholder consensus process supported by US EPA.

EPEAT system helps purchasers in the public and private sectors evaluate, compare and select desktop computers, notebooks and monitors based on their environmental attributes. EPEAT also provides a clear and consistent set of performance criteria for the design of products, and provides an opportunity for manufacturers to secure market recognition for efforts to reduce the environmental impact of its products.

Benefits of EPEAT

Reduce use of primary materials
Reduce use of toxic materials

Avoid the disposal of hazardous waste EPEAT'S requirement that all registered products meet ENERGY STAR's energy efficiency specifications, means that these products will consume less energy throughout their life.

CE Declaration of Conformity



This product is in conformity with the following standards

- EN60950-1:2006+A11:2009+A1:2010+A12:2011+A2:2013(Safety requirement of Information Technology Equipment).
 - EN55022:2010(Radio Disturbance requirement of Information Technology Equipment).
 - EN55024:2010 (Immunity requirement of Information Technology Equipment).
 - EN61000-3-2:2006+A1:2009+A2:2009 (Limits for Harmonic Current Emission).
 - EN61000-3-3:2008 (Limitation of Voltage Fluctuation and Flicker) following provisions of directives applicable.
 - EN50581:2012 (Technical documentation for the assessment of electrical and electronic products with respect to the restriction of hazardous substances)
 - EN 50564:2011 (Electrical and electronic household and office equipment — Measurement of low power consumption) following provisions of directives applicable
 - 2006/95/EC (Low Voltage Directive).
 - 2004/108/EC (EMC Directive).
 - 2009/125/EC (ErP Directive, EC No. 1275/2008 Implementing Directive for Standby and Off mode power consumption)
 - 2011/65/EU (RoHS Directive) and is produced by a manufacturing organization on ISO9000 level
- And is produced by a manufacturing organization on ISO9000 level.
- ISO9241-307:2008 (Ergonomic requirement, Analysis and compliance test methods for electronic visual displays).
 - GS EK1-2000:2011 (GS mark requirement).

6. Regulatory Information

- prEN50279:1998 (Low Frequency Electric and Magnetic fields for Visual Display).
- MPR-II (MPR:1990:8/1990:10 Low Frequency Electric and Magnetic fields).
- TCO CERTIFIED (Requirement for Environment Labeling of Ergonomics, Energy, Ecology and Emission, TCO: Swedish Confederation of Professional Employees) for TCO versions.

Energy Star Declaration

(www.energystar.gov)



As an ENERGY STAR® Partner, we have determined that this product meets the ENERGY STAR® guidelines for energy efficiency.

Note

We recommend you switch off the monitor when it is not in use for a long time.

Federal Communications Commission (FCC) Notice (U.S. Only)

- This equipment has been tested and found to comply with the limits for a Class B digital device, pursuant to Part 15 of the FCC Rules. These limits are designed to provide reasonable protection against harmful interference in a residential installation. This equipment generates, uses and can radiate radio frequency energy and, if not installed and used in accordance with the instructions, may cause harmful interference to radio communications.

However, there is no guarantee that interference will not occur in a particular installation. If this equipment does cause harmful interference to radio or television reception, which can be determined by turning the equipment off and on, the user is encouraged to try to correct the interference by one or more of the following measures:

- Reorient or relocate the receiving antenna.

- Increase the separation between the equipment and receiver.
- Connect the equipment into an outlet on a circuit different from that to which the receiver is connected.
- Consult the dealer or an experienced radio/TV technician for help.
- **!** Changes or modifications not expressly approved by the party responsible for compliance could void the user's authority to operate the equipment.

Use only RF shielded cable that was supplied with the monitor when connecting this monitor to a computer device.

To prevent damage which may result in fire or shock hazard, do not expose this appliance to rain or excessive moisture.

THIS CLASS B DIGITAL APPARATUS MEETS ALL REQUIREMENTS OF THE CANADIAN INTERFERENCE-CAUSING EQUIPMENT REGULATIONS.

FCC Declaration of Conformity

Declaration of Conformity for Products Marked with FCC Logo,

United States Only



This device complies with Part 15 of the FCC Rules. Operation is subject to the following two conditions: (1) this device may not cause harmful interference, and (2) this device must accept any interference received, including interference that may cause undesired operation.

Commission Federale de la Communication (FCC Declaration)

- Cet équipement a été testé et déclaré conforme aux limites des appareils numériques de class B, aux termes de l'article 15 Des règles de la FCC. Ces limites sont conçues de façon à fournir une protection raisonnable contre les

6. Regulatory Information

interférences nuisibles dans le cadre d'une installation résidentielle.

CET appareil produit, utilise et peut émettre des hyperfréquences qui, si l'appareil n'est pas installé et utilisé selon les consignes données, peuvent causer des interférences nuisibles aux communications radio.

Cependant, rien ne peut garantir l'absence d'interférences dans le cadre d'une installation particulière. Si cet appareil est la cause d'interférences nuisibles pour la réception des signaux de radio ou de télévision, ce qui peut être décelé en fermant l'équipement, puis en le remettant en fonction, l'utilisateur pourrait essayer de corriger la situation en prenant les mesures suivantes:

- Réorienter ou déplacer l'antenne de réception.
- Augmenter la distance entre l'équipement et le récepteur.
- Brancher l'équipement sur un autre circuit que celui utilisé par le récepteur.
- Demander l'aide du marchand ou d'un technicien chevronné en radio/télévision.

! Toutes modifications n'ayant pas reçu l'approbation des services compétents en matière de conformité est susceptible d'interdire à l'utilisateur l'usage du présent équipement.

N'utiliser que des câbles RF armés pour les connections avec des ordinateurs ou périphériques.

CET APPAREIL NUMERIQUE DE LA CLASSE B RESPECTE TOUTES LES EXIGENCES DU REGLEMENT SUR LE MATERIEL BROUILLEUR DU CANADA.

EN 55022 Compliance (Czech Republic Only)

This device belongs to category B devices as described in EN 55022, unless it is specifically stated that it is a Class A device on the specification label. The following applies to devices in Class A of EN 55022 (radius of protection up to 30 meters). The user of the device is obliged to take all steps necessary to remove sources of interference to telecommunication or other devices.

Pokud není na typovém štítku počítače uvedeno, že spadá do třídy A podle EN 55022, spadá automaticky do třídy B podle EN 55022. Pro zařízení zařazená do třídy A (chranné pásmo 30m) podle EN 55022 platí následující. Dojde-li k rušení telekomunikačních nebo jiných zařízení je uživatel povinen provést taková opatření, aby rušení odstranil.

Polish Center for Testing and Certification Notice

The equipment should draw power from a socket with an attached protection circuit (a three-prong socket). All equipment that works together (computer, monitor, printer, and so on) should have the same power supply source.

The phasing conductor of the room's electrical installation should have a reserve short-circuit protection device in the form of a fuse with a nominal value no larger than 16 amperes (A).

To completely switch off the equipment, the power supply cable must be removed from the power supply socket, which should be located near the equipment and easily accessible.

A protection mark "B" confirms that the equipment is in compliance with the protection usage requirements of standards PN-93/T-42107 and PN-89/E-06251.

Wymagania Polskiego Centrum Badań i Certyfikacji

Urządzenie powinno być zasilane z gniazda z przyłączonym obwodem ochronnym (gniazdo z kółkiem). Współpracujące ze sobą urządzenia (komputer, monitor, drukarka) powinny być zasilane z tego samego źródła.

Instalacja elektryczna pomieszczenia powinna zawierać w przewodzie fazowym rezerwową ochronę przed zwarciami, w postaci bezpiecznika o wartości znamionowej nie większej niż 16A (amperów).

W celu całkowitego wyłączenia urządzenia z sieci zasilania, należy wyjąć wtyczkę kabla zasilającego z gniazda, które powinno znajdować się w pobliżu urządzenia i być łatwo dostępne.

Znak bezpieczeństwa "B" potwierdza zgodność urządzenia z wymaganiami bezpieczeństwa użytkownika zawartymi w PN-93/T-42107 i PN-89/E-06251.

Pozostałe instrukcje bezpieczeństwa

- Nie należy używać wtyczek adapterowych lub usuwać kółka obwodu ochronnego z wtyczki. Jeżeli konieczne jest użycie przedłużacza to należy użyć przedłużacza 3-żyłowego z prawidłowo połączonym przewodem ochronnym.
- System komputerowy należy zabezpieczyć przed nagłymi, chwilowymi wzrostami lub spadkami napięcia, używając eliminatora przepięć, urządzenia dopasowującego lub bezzakłócenowego źródła zasilania.
- Należy upewnić się, aby nic nie leżało na kablach systemu komputerowego, oraz aby kable nie były umieszczone w miejscu, gdzie można byłoby na nie nadepnąć lub potykać się o nie.
- Nie należy rozlewać napojów ani innych płynów na system komputerowy.
- Nie należy wpychać żadnych przedmiotów do otworów systemu komputerowego, gdyż może to spowodować pożar lub porażenie prądem, poprzez zwarcie elementów wewnętrznych.
- System komputerowy powinien znajdować się z dala od grzejników i źródeł ciepła. Ponadto, nie należy blokować otworów wentylacyjnych. Należy unikać kładzenia luznych papierów pod komputer oraz umieszczania komputera w ciasnym miejscu bez możliwości cyrkulacji powietrza wokół niego.

6. Regulatory Information

North Europe (Nordic Countries) Information

Placering/Ventilation

VARNING:

FÖRSÄKRA DIG OM ATT HUVUDBRYTARE OCH UTTAG ÄR LÄTÅTKOMLIGA, NÄR DU STÄLLER DIN UTRUSTNING PÅPLATS.

Placering/Ventilation

ADVARSEL:

SØRG VED PLACERINGEN FOR, AT NETLEDNINGENS STIK OG STIKKONTAKT ER NEMT TILGÆNGELIGE.

Paikka/Ilmankierto

VAROITUS:

SIIJOITA LAITE SITEN, ETTÄ VERKKOJOHTO VOIDAAN TARVITTAESSA HELPOSTI IRROTTAA PISTORASIESTA.

Plassering/Ventilasjon

ADVARSEL:

NÅR DETTE UTSTYRET Plasseres, MÅ DU PASSE PÅ AT KONTAKTENE FOR STØMTILFØRSEL ER LETTE Å NÅ.

BSMI Notice (Taiwan Only)

符合乙類資訊產品之標準

Ergonomie Hinweis (nur Deutschland)

Der von uns gelieferte Farbmonitor entspricht den in der "Verordnung über den Schutz vor Schäden durch Röntgenstrahlen" festgelegten Vorschriften.

Auf der Rückwand des Gerätes befindet sich ein Aufkleber, der auf die Unbedenklichkeit der Inbetriebnahme hinweist, da die Vorschriften über die Bauart von Störstrahlern nach Anlage III \square 5 Abs. 4 der Röntgenverordnung erfüllt sind.

Damit Ihr Monitor immer den in der Zulassung geforderten Werten entspricht, ist darauf zu achten, daß

1. Reparaturen nur durch Fachpersonal durchgeführt werden.
2. nur original-Ersatzteile verwendet werden.
3. bei Ersatz der Bildröhre nur eine bauartgleiche eingebaut wird.

Aus ergonomischen Gründen wird empfohlen, die Grundfarben Blau und Rot nicht auf dunklem Untergrund zu verwenden (schlechte Lesbarkeit und erhöhte Augenbelastung bei zu geringem Zeichenkontrast wären die Folge). Der arbeitsplatzbezogene Schalldruckpegel nach DIN 45 635 beträgt 70dB (A) oder weniger.

-  **ACHTUNG: BEIM AUFSTELLEN DIESES GERÄTES DARAUf ACHTEN, DAß NETZSTECKER UND NETZKABELANSCHLUß LEICHT ZUGÄNGLICH SIND.**

6. Regulatory Information

EU Energy Label



The European Energy Label informs you on the energy efficiency class of this product. The greener the energy efficiency class of this product is the lower the energy it consumes.

On the label, you can find the energy efficiency class, the average power consumption of this product in use and the average energy consumption for 1 year.

Note

The EU Energy Label will be **ONLY** applied on the models bundling with HDMI and TV tuners.

China RoHS

The People's Republic of China released a regulation called "Management Methods for Controlling Pollution by Electronic Information Products" or commonly referred to as China RoHS. All products produced and sold for China market have to meet China RoHS request.

中国电子信息产品污染控制标识要求(中国RoHS法规标示要求)产品中有毒有害物质或元素的名称及含量

部件名称	有毒有害物质或元素					
	铅 (Pb)	汞 (Hg)	镉 (Cd)	六价铬 (Cr6+)	多溴联苯 (PBB)	多溴二苯醚 (PBDE)
外壳	○	○	○	○	○	○
液晶显示屏/灯管	×	○	○	○	○	○
电路板组件*	×	○	○	○	○	○
电源适配线	×	○	○	○	○	○
电源线/连接线	×	○	○	○	○	○

*: 电路板组件包括印刷电路板及其构成的零部件，如电阻、电容、集成电路、连接器等。

○: 表示该有毒有害物质在该部件所有均质材料中的含量均在GB/T26572-2011规定的限量要求以下。

×: 表示该有毒有害物质至少在该部件的某一均质材料中的含量超出GB/T26572-2011规定的限量要求。

备注：以上“×”的部件中，部分含有有害物质超过是由于目前行业技术水平所限，暂时无法实现替代或减量化。

Restriction on Hazardous Substances statement (India)

This product complies with the "India E-waste Rule 2011" and prohibits use of lead, mercury, hexavalent chromium, polybrominated biphenyls or polybrominated diphenyl ethers in concentrations exceeding 0.1 weight % and 0.01 weight % for cadmium, except for the exemptions set in Schedule 2 of the Rule.

E-Waste Declaration for India

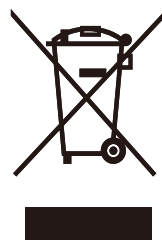

This symbol on the product or on its packaging indicates that this product must not be disposed of with your other household waste. Instead it is your responsibility to dispose of

6. Regulatory Information

your waste equipment by handing it over to a designated collection point for the recycling of waste electrical and electronic equipment. The separate collection and recycling of your waste equipment at the time of disposal will help to conserve natural resources and ensure that it is recycled in a manner that protects human health and the environment. For more information about where you can drop off your waste equipment for recycling in India please visit the below web link.

<http://www.india.philips.com/about/sustainability/recycling/index.page>



环保使用期限

此标识指期限(十年),电子信息产品中含有的有毒有害物质或元素在正常使用的条件下不会发生外泄或突变,电子信息产品用户使用该电子信息产品不会对环境造成严重污染或对其人身、财产造成严重损害的期限。

中国能源效率标识

根据中国大陆《能源效率标识管理办法》本显示器符合以下要求：

能源效率(cd/W)	> 1.05
能效等级	1 级
能效标准	GB 21520-2008

详细有关信息请查阅中国能效标识网：<http://www.energylabel.gov.cn/>

《废弃电器电子产品回收处理管理条例》提示性说明

为了更好地关爱及保护地球，当用户不再需要此产品或产品寿命终止时，请遵守国家废弃电器电子产品回收处理相关法律法规，将其交给当地具有国家认可的回收处理资质的厂商进行回收处理。



VCCI-B

この装置は、クラスB情報技術装置です。この装置は、家庭環境で使用することを目的としていますが、この装置がラジオやテレビジョン受信機に近接して使用されると、受信障害を引き起こすことがあります。取扱説明書に従って正しい取り扱いをして下さい。

粗分類	化学物質表					
	Pb	Hg	Cd	Cr6+	PBBs	PBDEs
前面ベゼル	0	0	0	0	0	0
背面カバー	0	0	0	0	0	0
スタンド	0	0	0	0	0	0
LCDパネル	WLED	適用除外の	0	0	0	0
	CCFL	適用除外の	適用除外の	0	0	0
PCBA	適用除外の	0	0	0	0	0
ケーブル&ワイヤ	適用除外の	0	0	0	0	0
リモコン	適用除外の	0	0	0	0	0

*:PCBAはベア印刷回路基板、で構成され、はんだ付けおよび抵抗器、コンデンサ、アレー、コネクタ、チップなど、その表面実装エレメントで構成されます。
注1:「0」は、計算される物質の含有率が参照含有率を超えていないことを示します。
注2:「適用除外」項目は、特定の化学物質がJIS C 0950の規格により適用除外とされた項目に対応することを意味します。
JIS C 0950

7. Customer care and warranty

7.1 Philips' Flat Panel Monitors Pixel Defect Policy

Philips strives to deliver the highest quality products. We use some of the industry's most advanced manufacturing processes and practice stringent quality control. However, pixel or sub pixel defects on the TFT Monitor panels used in flat panel monitors are sometimes unavoidable. No manufacturer can guarantee that all panels will be free from pixel defects, but Philips guarantees that any monitor with an unacceptable number of defects will be repaired or replaced under warranty. This notice explains the different types of pixel defects and defines acceptable defect levels for each type. In order to qualify for repair or replacement under warranty, the number of pixel defects on a TFT Monitor panel must exceed these acceptable levels. For example, no more than 0.0004% of the sub pixels on a monitor may be defective. Furthermore, Philips sets even higher quality standards for certain types or combinations of pixel defects that are more noticeable than others. This policy is valid worldwide.

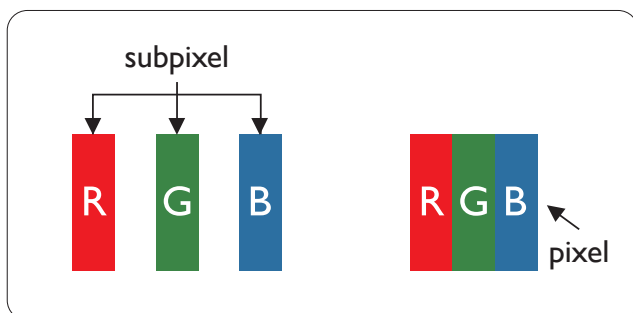

Pixels and Sub pixels

A pixel, or picture element, is composed of three sub pixels in the primary colors of red, green and blue. Many pixels together form an image. When all sub pixels of a pixel are lit, the three colored sub pixels together appear as a single white pixel. When all are dark, the three colored sub pixels together appear as a single

black pixel. Other combinations of lit and dark sub pixels appear as single pixels of other colors.

Types of Pixel Defects

Pixel and sub pixel defects appear on the screen in different ways. There are two categories of pixel defects and several types of sub pixel defects within each category.

Bright Dot Defects

Bright dot defects appear as pixels or sub pixels that are always lit or 'on'. That is, a bright dot is a sub-pixel that stands out on the screen when the monitor displays a dark pattern. There are the types of bright dot defects.

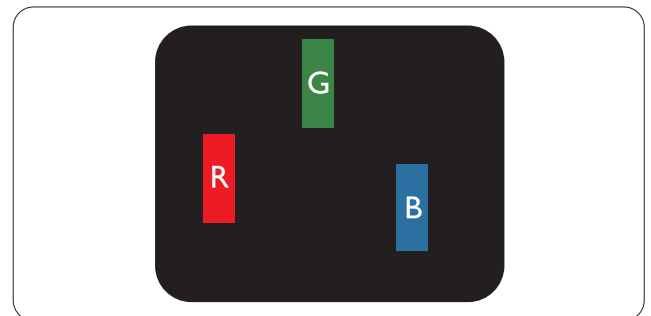

One lit red, green or blue sub pixel.

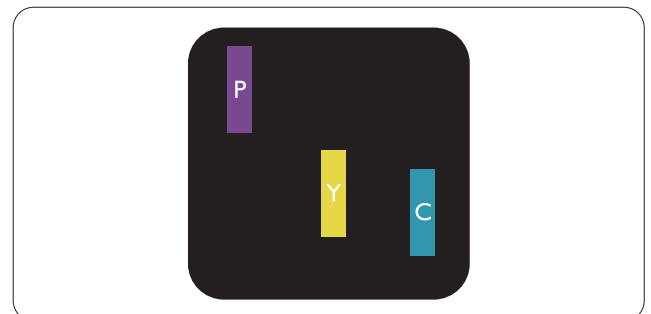

Two adjacent lit sub pixels:

- Red + Blue = Purple
- Red + Green = Yellow
- Green + Blue = Cyan (Light Blue)

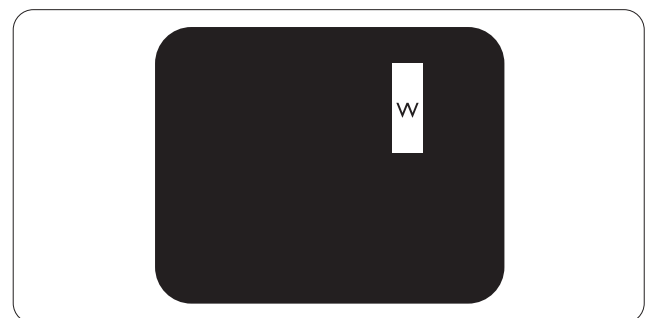

Three adjacent lit sub pixels (one white pixel).

Note

A red or blue bright dot must be more than 50 percent brighter than neighboring dots while a green bright dot is 30 percent brighter than neighboring dots.

Black Dot Defects

Black dot defects appear as pixels or sub pixels that are always dark or 'off'. That is, a dark dot is a sub-pixel that stands out on the screen when the monitor displays a light pattern. These are the types of black dot defects.

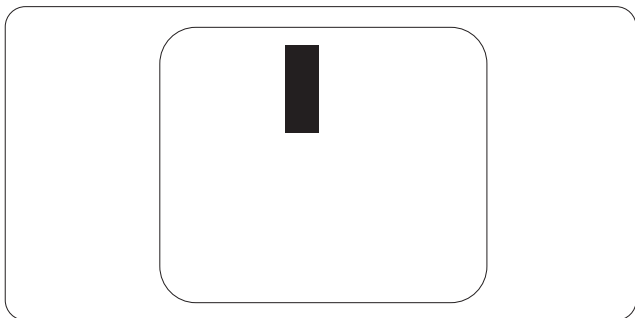

Proximity of Pixel Defects

Because pixel and sub pixels defects of the same type that are near to one another may be more noticeable, Philips also specifies tolerances for the proximity of pixel defects.

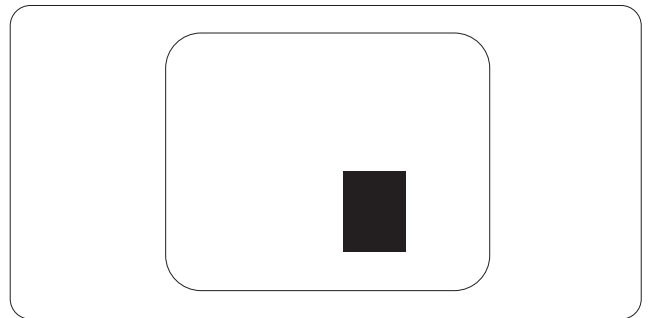

Pixel Defect Tolerances

In order to qualify for repair or replacement due to pixel defects during the warranty period, a TFT Monitor panel in a Philips flat panel monitor must have pixel or sub pixel defects exceeding the tolerances listed in the following tables.

BRIGHT DOT DEFECTS	ACCEPTABLE LEVEL
1 lit subpixel	3
2 adjacent lit subpixels	1
3 adjacent lit subpixels (one white pixel)	0
Distance between two bright dot defects*	>15mm
Total bright dot defects of all types	3
BLACK DOT DEFECTS	ACCEPTABLE LEVEL
1 dark subpixel	5 or fewer
2 adjacent dark subpixels	2 or fewer
3 adjacent dark subpixels	0
Distance between two black dot defects*	>15mm
Total black dot defects of all types	5 or fewer
TOTAL DOT DEFECTS	ACCEPTABLE LEVEL
Total bright or black dot defects of all types	5 or fewer

Note

- 1 or 2 adjacent sub pixel defects = 1 dot defect
- This monitor is ISO9241-307 compliant (ISO9241-307: Ergonomic requirement, analysis and compliance test methods for electronic visual displays)
- ISO9241-307 is the successor of formerly known ISO13406 standard, which is withdrawn by the International Organisation for Standardisation (ISO) per: 2008-11-13.

7.2 Customer Care & Warranty

For warranty coverage information and additional support requirement valid for your region, please visit www.philips.com/support website for details. You may also contact your local Philips Customer Care Center number listed below.

Contact Information for WESTERN EUROPE region:

Country	CSP	Hotline Number	Price	Opening Hours
Austria	RTS	+43 0810 000206	€ 0.07	Mon to Fri : 9am - 6pm
Belgium	Ecare	+32 078 250851	€ 0.06	Mon to Fri : 9am - 6pm
Cyprus	Alman	800 92 256	Free of charge	Mon to Fri : 9am - 6pm
Denmark	Infocare	+45 3525 8761	Local call tariff	Mon to Fri : 9am - 6pm
Finland	Infocare	+358 09 2290 1908	Local call tariff	Mon to Fri : 9am - 6pm
France	Mainteq	+33 082161 1658	€ 0.09	Mon to Fri : 9am - 6pm
Germany	RTS	+49 01803 386 853	€ 0.09	Mon to Fri : 9am - 6pm
Greece	Alman	+30 00800 3122 1223	Free of charge	Mon to Fri : 9am - 6pm
Ireland	Celestica	+353 01 601 1161	Local call tariff	Mon to Fri : 8am - 5pm
Italy	Anovo Italy	+39 840 320 041	€ 0.08	Mon to Fri : 9am - 6pm
Luxembourg	Ecare	+352 26 84 30 00	Local call tariff	Mon to Fri : 9am - 6pm
Netherlands	Ecare	+31 0900 0400 063	€ 0.10	Mon to Fri : 9am - 6pm
Norway	Infocare	+47 2270 8250	Local call tariff	Mon to Fri : 9am - 6pm
Poland	MSI	+48 0223491505	Local call tariff	Mon to Fri : 9am - 6pm
Portugal	Mainteq	800 780 902	Free of charge	Mon to Fri : 8am - 5pm
Spain	Mainteq	+34 902 888 785	€ 0.10	Mon to Fri : 9am - 6pm
Sweden	Infocare	+46 08 632 0016	Local call tariff	Mon to Fri : 9am - 6pm
Switzerland	ANOVO CH	+41 02 2310 2116	Local call tariff	Mon to Fri : 9am - 6pm
United Kingdom	Celestica	+44 0207 949 0069	Local call tariff	Mon to Fri : 8am - 5pm

Contact Information for China:

Country	Call center	Consumer care number
China	PCCW Limited	4008 800 008

Contact Information for NORTH AMERICA :

Country	Call center	Consumer care number
U.S.A.	EPI-e-center	(877) 835-1838
Canada	EPI-e-center	(800)479-6696

7. Customer care and warranty

Contact Information for CENTRAL AND EASTERN EUROPE region:

Country	Call center	CSP	Consumer care number
Belarus	NA	IBA	+375 17 217 3386 +375 17 217 3389
Bulgaria	NA	LAN Service	+359 2 960 2360
Croatia	NA	MR Service Ltd	+385 (01) 640 1111
Czech Rep.	NA	Asupport	420 272 188 300
Estonia	NA	FUJITSU	+372 6519900(General) +372 6519972(workshop)
Georgia	NA	Esabi	+995 322 91 34 71
Hungary	NA	Profi Service	+36 1 814 8080(General) +36 1814 8565(For AOC&Philips only)
Kazakhstan	NA	Classic Service I.l.c.	+7 727 3097515
Latvia	NA	ServiceNet LV	+371 67460399 +371 27260399
Lithuania	NA	UAB Servicenet	+370 37 400160(general) +370 7400088 (for Philips)
Macedonia	NA	AMC	+389 2 3125097
Moldova	NA	Comel	+37322224035
Romania	NA	Skin	+40 21 2101969
Russia	NA	CPS	+7 (495) 645 6746
Serbia&Montenegro	NA	Kim Tec d.o.o.	+381 11 20 70 684
Slovakia	NA	Datalan Service	+421 2 49207155
Slovenia	NA	PC H.and	+386 1 530 08 24
the republic of Belarus	NA	ServiceBy	+ 375 17 284 0203
Turkey	NA	Tecpro	+90 212 444 4 832
Ukraine	NA	Topaz	+38044 525 64 95
Ukraine	NA	Comel	+380 5627444225

Contact Information for LATIN AMERICA region:

Country	Call center	Consumer care number
Brazil	Vermont	0800-7254101
Argentina		0800 3330 856

7. Customer care and warranty

Contact Information for APMEA region:

Country	ASP	Consumer care number	Opening hours
Australia	AGOS NETWORK PTY LTD	1300 360 386	Mon.~Fri. 9:00am-5:30pm
New Zealand	Visual Group Ltd.	0800 657447	Mon.~Fri. 8:30am-5:30pm
Hong Kong Macau	Company: Smart Pixels Technology Ltd.	Hong Kong: Tel: +852 2619 9639 Macau:Tel: (853)-0800-987	Mon.~Fri. 9:00am-6:00pm Sat. 9:00am-1:00pm
India	REDINGTON INDIA LTD	Tel: 1 800 425 6396 SMS: PHILIPS to 56677	Mon.~Fri. 9:00am-5:30pm
Indonesia	PT. CORMIC SERVISINDO PERKASA	+62-21-4080-9086 (Customer Hotline) +62-8888-01-9086 (Customer Hotline)	Mon.~Thu. 08:30-12:00; 13:00-17:30 Fri. 08:30-11:30; 13:00-17:30
Korea	Alphascan Displays, Inc	1661-5003	Mon.~Fri. 9:00am-5:30pm Sat. 9:00am-1:00pm
Malaysia	R-Logic Sdn Bhd	+603 5102 3336	Mon.~Fri. 8:15am-5:00pm Sat. 8:30am-12:30am
Pakistan	TVONICS Pakistan	+92-213-6030100	Sun.~Thu. 10:00am-6:00pm
Singapore	Philips Electronics Singapore Pte Ltd (Philips Consumer Care Center)	(65) 6882 3966	Mon.~Fri. 9:00am-6:00pm Sat. 9:00am-1:00pm
Taiwan	FETEC.CO	0800-231-099	Mon.~Fri. 09:00 - 18:00
Thailand	Axis Computer System Co., Ltd.	(662) 934-5498	Mon.~Fri. 8:30am~05:30pm
South Africa	Computer Repair Technologies	011 262 3586	Mon.~Fri. 8:00am~05:00pm
Israel	Eastronics LTD	1-800-567000	Sun.~Thu. 08:00-18:00
Vietnam	FPT Service Informatic Company Ltd. - Ho Chi Minh City Branch	+84 8 38248007 Ho Chi Minh City +84 5113.562666 Danang City +84 5113.562666 Can tho Province	Mon.~Fri. 8:00-12:00, 13:30- 17:30,Sat. 8:00-12:00
Philippines	EA Global Supply Chain Solutions ,Inc.	(02) 655-7777; 6359456	Mon.~Fri. 8:30am~5:30pm
Armenia Azerbaijan Georgia Kyrgyzstan Tajikistan	Firebird service centre	+97 14 8837911	Sun.~Thu. 09:00 - 18:00
Uzbekistan	Soniko Plus Private Enterprise Ltd	+99871 2784650	Mon.~Fri. 09:00 - 18:00
Turkmenistan	Technostar Service Centre	+(99312) 460733, 460957	Mon.~Fri. 09:00 - 18:00
Japan	フィリップスモニター ・サポートセンター	0120-060-530	Mon.~Fri. 10:00 - 17:00

8. Troubleshooting & FAQs

8.1 Troubleshooting

This page deals with problems that can be corrected by a user. If the problem still persists after you have tried these solutions, contact Philips customer service representative.

1 Common Problems

No Picture (Power LED not lit)

- Make sure the power cord is plugged into the power outlet and into the back of the monitor.
- First, ensure that the power button on the front of the monitor is in the OFF position, then press it to the ON position.

No Picture (Power LED is White)

- Make sure the computer is turned on.
- Make sure the signal cable is properly connected to your computer.
- Make sure the monitor cable has no bent pins on the connect side. If yes, repair or replace the cable.
- The Energy Saving feature may be activated

Screen says

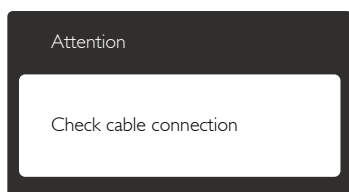

- Make sure the monitor cable is properly connected to your computer. (Also refer to the Quick Start Guide).
- Check to see if the monitor cable has bent pins.
- Make sure the computer is turned on.

AUTO button doesn't function

- The auto function is applicable only in VGA-Analog mode. If the result is not

satisfactory, you can do manual adjustments via the OSD menu.

Note

The Auto Function is not applicable in DVI-Digital mode as it is not necessary.

Visible signs of smoke or sparks

- Do not perform any troubleshooting steps
- Disconnect the monitor from mains power source immediately for safety
- Contact with Philips customer service representative immediately.

2 Imaging Problems

Image is not centered

- Adjust the image position using the "Auto" function in OSD Main Controls.
- Adjust the image position using the Phase/Clock of Setup in OSD Main Controls. It is valid only in VGA mode.

Image vibrates on the screen

- Check that the signal cable is properly securely connected to the graphics board or PC.

Vertical flicker appears



- Adjust the image using the "Auto" function in OSD Main Controls.
- Eliminate the vertical bars using the Phase/Clock of Setup in OSD Main Controls. It is valid only in VGA mode.

Horizontal flicker appears



- Adjust the image using the "Auto" function in OSD Main Controls.

8. Troubleshooting & FAQs

- Eliminate the vertical bars using the Phase/Clock of Setup in OSD Main Controls. It is valid only in VGA mode.

Image appears blurred, indistinct or too dark

- Adjust the contrast and brightness on On-Screen Display.

An "after-image", "burn-in" or "ghost image" remains after the power has been turned off.

- Uninterrupted display of still or static images over an extended period may cause "burn in", also known as "after-imaging" or "ghost imaging", on your screen. "Burn-in", "after-imaging", or "ghost imaging" is a well-known phenomenon in LCD panel technology. In most cases, the "burned in" or "after-imaging" or "ghost imaging" will disappear gradually over a period of time after the power has been switched off.
- Always activate a moving screen saver program when you leave your monitor unattended.
- Always activate a periodic screen refresh application if your LCD monitor will display unchanging static content.
- Failure to activate a screen saver, or a periodic screen refresh application may result in severe "burn-in" or "after-image" or "ghost image" symptoms that will not disappear and cannot be repaired. The damage mentioned above is not covered under your warranty.

Image appears distorted. Text is fuzzy or blurred.

- Set the PC's display resolution to the same mode as monitor's recommended screen native resolution.

Green, red, blue, dark, and white dots appears on the screen

- The remaining dots are normal characteristic of the liquid crystal used in today's technology, Please refer the pixel policy for more detail.

The "power on" light is too strong and is disturbing

- You can adjust "power on" light using the power LED Setup in OSD main Controls.

For further assistance, refer to the Consumer Information Centers list and contact Philips customer service representative.

8.2 SmartControl Premium FAQs

Q1. I change the monitor on a PC to a different one and the SmartControl Premium becomes un-usable, what do I do?

Ans.: Restart your PC and see if SmartControl Premium can work. Otherwise, you will need to remove and re-install SmartControl Premium to ensure proper driver is installed.

Q2. The SmartControl Premium functions worked well before, but it does not work anymore, what can I do?

Ans.: If the following actions were executed, the monitor driver may need to be re-installed.

- Changed video graphic adapter to another one
- Updated video driver
- Activities on OS, such as service pack or patch
- Run Windows Update and updated monitor and/or video driver
- Windows was booted with the monitor power off or disconnected.
- To find out, please right click My Computer and click on Properties->Hardware->Device Manager.
- If you see "Plug and Play Monitor" shows under Monitor; then you need to re-install. Simply remove SmartControl Premium and re-install it.

Q3. After installing SmartControl Premium, when clicking on SmartControl Premium tab, nothing shows up after a while or a failure message shows, what happened?

Ans.: It might be your graphic adaptor is not compatible with the SmartControl Premium. If your graphic adaptor is one of the above mentioned brands, try to download the most updated graphic adaptor driver from corresponding companies' web site. Install the driver. Remove SmartControl Premium, and re-install it once more.
If it is still not working, we are sorry that the graphic adaptor is not supported. Please visit Philips website and check if an updated SmartControl Premium driver is available.

Q4. When I click on Product Information, only partial information is shown, what happened?

Ans.: It might be your graphic card adaptor driver is not the most updated version which fully supporting DDC/CI interface. Please try to download the most updated graphic adaptor driver from corresponding companies' web site. Install the driver. Remove SmartControl Premium and re-install it once more.

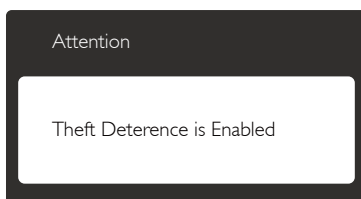

Q5. I forgot my PIN for Theft Deterrence Function. How can I do?

Ans.: Philips Service center has a right to ask for legitimate identification and authorization, in order to establish ownership of the monitor.

8.3 General FAQs

Q1: When I install my monitor what should I do if the screen shows 'Cannot display this video mode'?

Ans.: Recommended resolution for this monitor: 2560 x 1440 @ 60 Hz.

- Unplug all cables, then connect your PC to the monitor that you used previously.
- In the Windows Start Menu, select Settings/Control Panel. In the Control Panel Window, select the Display icon. Inside the Display Control Panel, select the 'Settings' tab. Under the setting tab, in box labelled 'desktop area', move the sidebar to 2560 x 1440 pixels.
- Open 'Advanced Properties' and set the Refresh Rate to 60 Hz, then click OK.
- Restart your computer and repeat step 2 and 3 to verify that your PC is set at 2560 x 1440 @ 60 Hz.
- Shut down your computer, disconnect your old monitor and reconnect your Philips LCD monitor.
- Turn on your monitor and then turn on your PC.

Q2: What is the recommended refresh rate for LCD monitor?

Ans.: Recommended refresh rate in LCD monitors is 60 Hz, In case of any disturbance on screen, you can set it up to 75 Hz to see if that removes the disturbance.

Q3: What are the .inf and .icm files on the CD-ROM? How do I install the drivers (.inf and .icm)?

Ans.: These are the driver files for your monitor. Follow the instructions in your user manual to install the drivers. Your computer may ask you for monitor drivers (.inf and .icm files) or a driver disk when you first install your monitor. Follow the instructions to insert the companion CD-ROM included in this

package. Monitor drivers (.inf and .icm files) will be installed automatically.

Q4: How do I adjust the resolution?

Ans.: Your video card/graphic driver and monitor together determine the available resolutions. You can select the desired resolution under Windows® Control Panel with the "Display properties".

Q5: What if I get lost when I am making monitor adjustments via OSD?

Ans.: Simply press the **OK** button, then select 'Reset' to recall all of the original factory settings.

Q6: Is the LCD screen resistant to scratches?

Ans.: In general it is recommended that the panel surface is not subjected to excessive shocks and is protected from sharp or blunt objects. When handling the monitor, make sure that there is no pressure or force applied to the panel surface side. This may affect your warranty conditions.

Q7: How should I clean the LCD surface?

Ans.: For normal cleaning, use a clean, soft cloth. For extensive cleaning, please use isopropyl alcohol. Do not use other solvents such as ethyl alcohol, ethanol, acetone, hexane, etc.

Q8: Can I change the color setting of my monitor?

Ans.: Yes, you can change your color setting through OSD control as the following procedures,

- Press "OK" to show the OSD (On Screen Display) menu
- Press "Down Arrow" to select the option "Color" then press "OK" to enter color setting, there are three settings as below.
 1. Color Temperature: The six settings are 5000K, 6500K, 7500K, 8200K, 9300K

and 11500K. With settings in the 5000K range the panel appears "warm, with a red-white color tone", while a 11500K temperature yields "cool, bluewhite toning".

2. sRGB: This is a standard setting for ensuring correct exchange of colors between different device (e.g. digital cameras, monitors, printers, scanners, etc).
3. User Define: The user can choose his/her preference color setting by adjusting red, green blue color.

 **Note**

A measurement of the color of light radiated by an object while it is being heated. This measurement is expressed in terms of absolute scale, (degrees Kelvin). Lower Kelvin temperatures such as 2004K are red; higher temperatures such as 9300K are blue. Neutral temperature is white, at 6504K.

Q9: Can I connect my LCD monitor to any PC, workstation or Mac?

Ans.: Yes. All Philips LCD monitors are fully compatible with standard PCs, Macs and workstations. You may need a cable adapter to connect the monitor to your Mac system. Please contact your Philips sales representative for more information.

Q10: Are Philips LCD monitors Plug-and-Play?

Ans.: Yes, the monitors are Plug-and-Play compatible with Windows 8.1/7/Vista/XP/NT, Mac OSX

Q11: What is Image Sticking, or Image Burn-in, or After Image, or Ghost Image in LCD panels?

Ans.: Uninterrupted display of still or static images over an extended period may cause "burn in", also known as "after-imaging" or "ghost imaging", on

your screen. "Burn-in", "after-imaging", or "ghost imaging" is a well-known phenomenon in LCD panel technology. In most cases, the "burned in" or "after-imaging" or "ghost imaging" will disappear gradually over a period of time after the power has been switched off.

Always activate a moving screen saver program when you leave your monitor unattended.

Always activate a periodic screen refresh application if your LCD monitor will display unchanging static content.

Warning

Failure to activate a screen saver, or a periodic screen refresh application may result in severe "burn-in" or "after-image" or "ghost image" symptoms that will not disappear and cannot be repaired. The damage mentioned above is not covered under your warranty.

Q12: Why is my Display not showing sharp text, and is displaying jagged characters?

Ans.: Your LCD monitor works best at its native resolution of 2560 x 1440 @ 60 Hz. For best display, please use this resolution.

Q13: How to unlock/lock my hot key?

Ans.: Please press /OK for 10 seconds to unlock/lock the hot key, by doing so, your monitor pops out "Attention" to show the unlock/lock status as shown below illustrators.

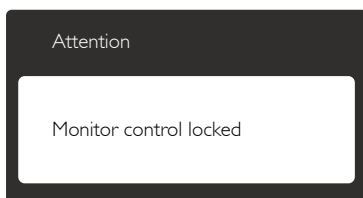
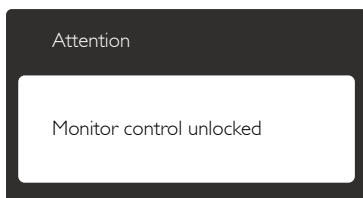

8.4 Multiview FAQs

Q1: Why I cannot activate PIP or PBP when the sources are DVI and HDMI?

Ans.: Please refer to below table for the main source and its supporting sub source.

MultiView	Inputs	SUB SOURCE POSSIBILITY (x1)			
		VGA	DP	DVI	MHL-HDMI
MAIN SOURCE (x1)	VGA		•	•	•
	DP	•		•	•
	DVI	•	•		•
	MHL-HDMI	•	•	•	

Q2: Can I enlarge the PIP sub window ?

Ans.: Yes, there are 3 sizes to select: [Small], [Middle], [Large]. You can press  to enter OSD menu. Select your preferred [PIP Size] option from the [PIP / PBP] main menu.

Q3: How to listen to Audio, independent of video?

Ans.: Normally the audio source is linked to the main picture source. If you want to change audio-source input (for example: listen to your MP3 player independently regardless of the video source input), you can press  to enter OSD menu. Select your preferred [Audio Source] option from the [Audio] main menu.

Please note that the next time you turn on your monitor, the monitor will by default select the audio source you chose last time. In case you want to change it again, you need to go through the above steps to select your new preferred audio source, which then will become the "default" mode.

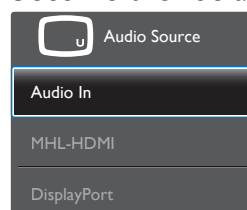



© 2014 Koninklijke Philips N.V. All rights reserved.

Philips and the Philips Shield Emblem are registered trademarks of Koninklijke Philips N.V. and are used under license from Koninklijke Philips N.V.

Specifications are subject to change without notice.

Version: BDM3270E1T